



**nuda.**

[verumitaly.com/nuda](http://verumitaly.com/nuda)

## L'UNICA MANIGLIA SENZA ROSETTA THE ONLY HANDLE WITHOUT THE ROSE

Nuda è una collezione di maniglie che utilizza un innovativo sistema brevettato che ne permette il fissaggio senza rosetta, perfetto per un design minimalista.

Il montaggio avviene in pochi secondi senza necessitare di competenze tecniche o attrezzature specifiche.

Nuda è adattabile a ogni spessore e tipologia di porta. Le sue funzionalità sono garantite secondo DIN 1906.

Nuda is a collection of handles with an innovative patented system whose assembly does not require anymore the rose.

A minimalist and design solution for any door. The assembly is very quick, it can be done in few seconds and it does not require any specific technical skills and tools.

Nuda can be adapted to any thickness and typology of door. The functionality of Nuda is guaranteed by DIN 1906.

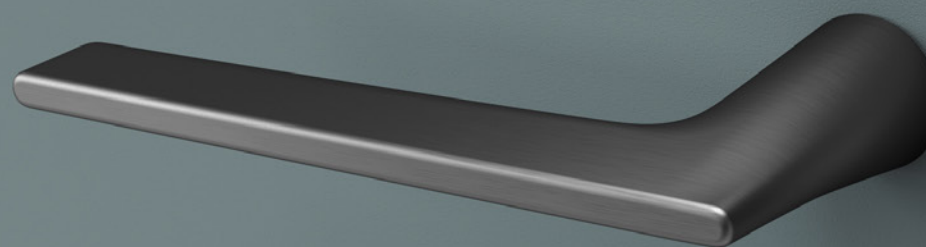
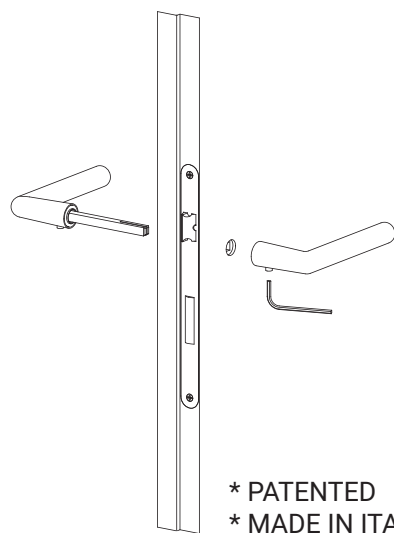

**LE MANIGLIE**  
THE HANDLES

**Pure** <sup>p.8</sup>



**Baar** <sup>p.10</sup>



**Lieve** <sup>p.12</sup>



**Pepe** <sup>p.14</sup>



**Wind** <sup>p.16</sup>



**Atlanta** <sup>p.18</sup>



**I POMOLI**  
THE KNOBS

**Lui** <sup>p.20</sup>



**Cham** <sup>p.22</sup>



**Soap** <sup>p.24</sup>



# Pure

design Mattia Ferremi

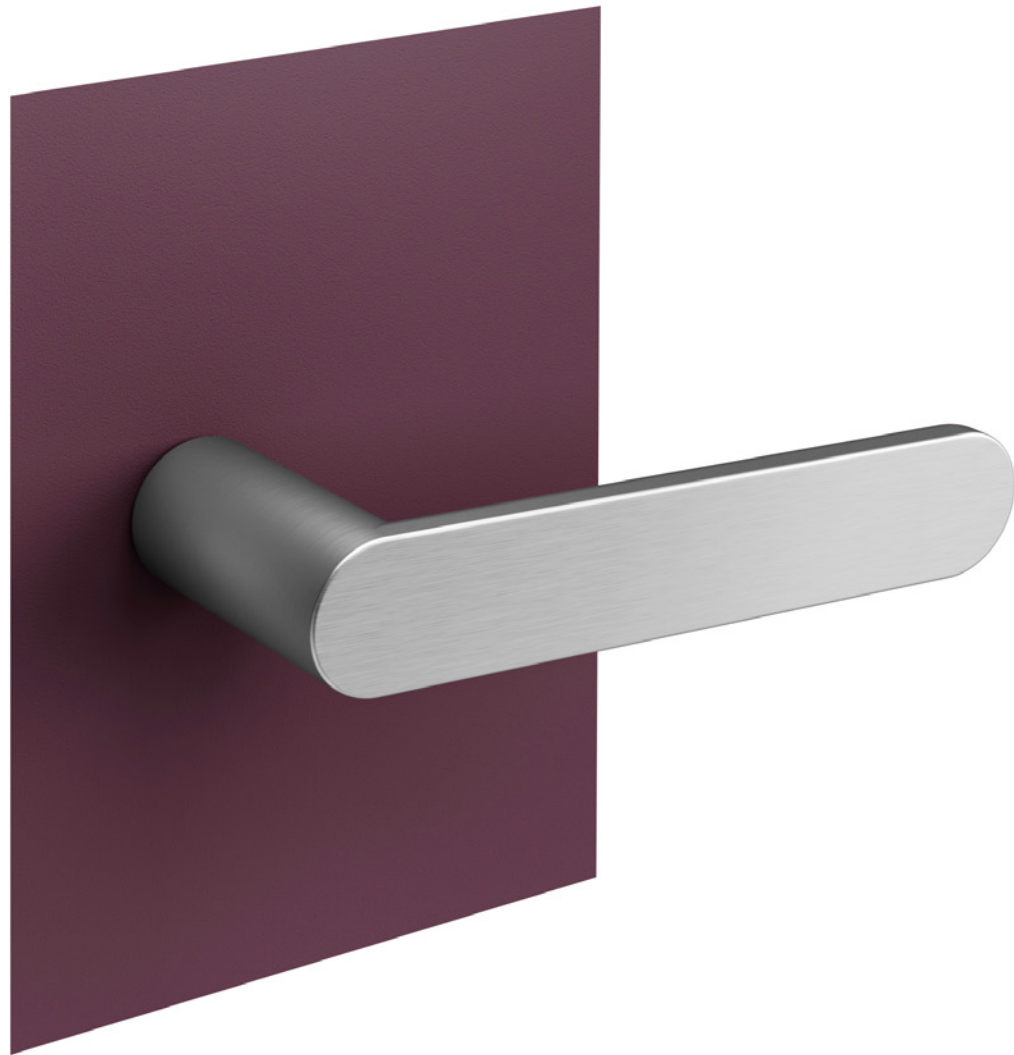

Cod. 127001  
 Materiale Zama / Material Zamak

**Porta door**

25  
 50  
 132

Quadro Spindle  $\square 8$

**Finestra window**





24  
 60  
 10  
 64  
 152

**Bocchette Escutcheons**

26  
 26  
 1  
 4  
 42  
 42

## FINITURE FINISHES

-  **Cromo Satinato**  
Satin Chrome
-  **Cromo Lucido**  
Polished Chrome
-  **Nero Etna**  
Etna Black
-  **Bianco Monviso**  
Monviso White
-  **Bronzo Yester**  
Yester Bronze

# Baar

design Alessandro Stabile

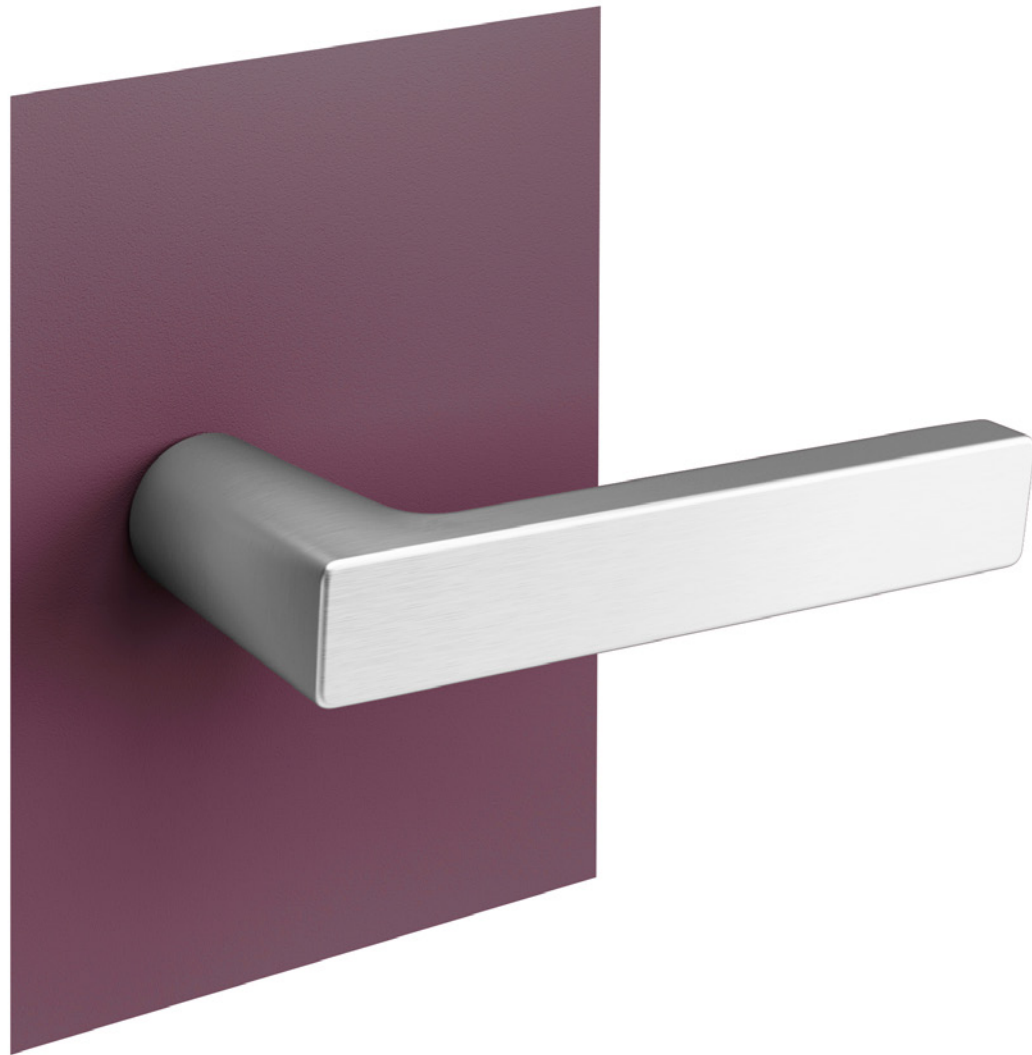

Cod. 127006  
Materiale Zama / Material Zamak

## Porta door

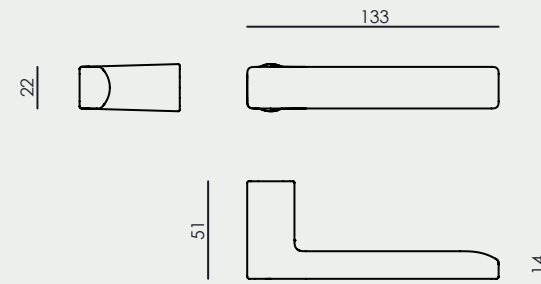

## Quadro Spindle $\square 8$

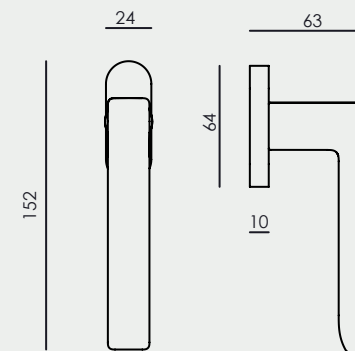

## Finestra window

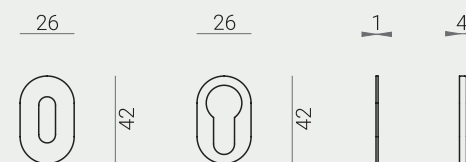

## Bocchette Escutcheons



## FINITURE FINISHES

-  **Cromo Satinato**  
Satin Chrome
-  **Nero Etna**  
Etna Black
-  **Bianco Monviso**  
Monviso White

# Lieve

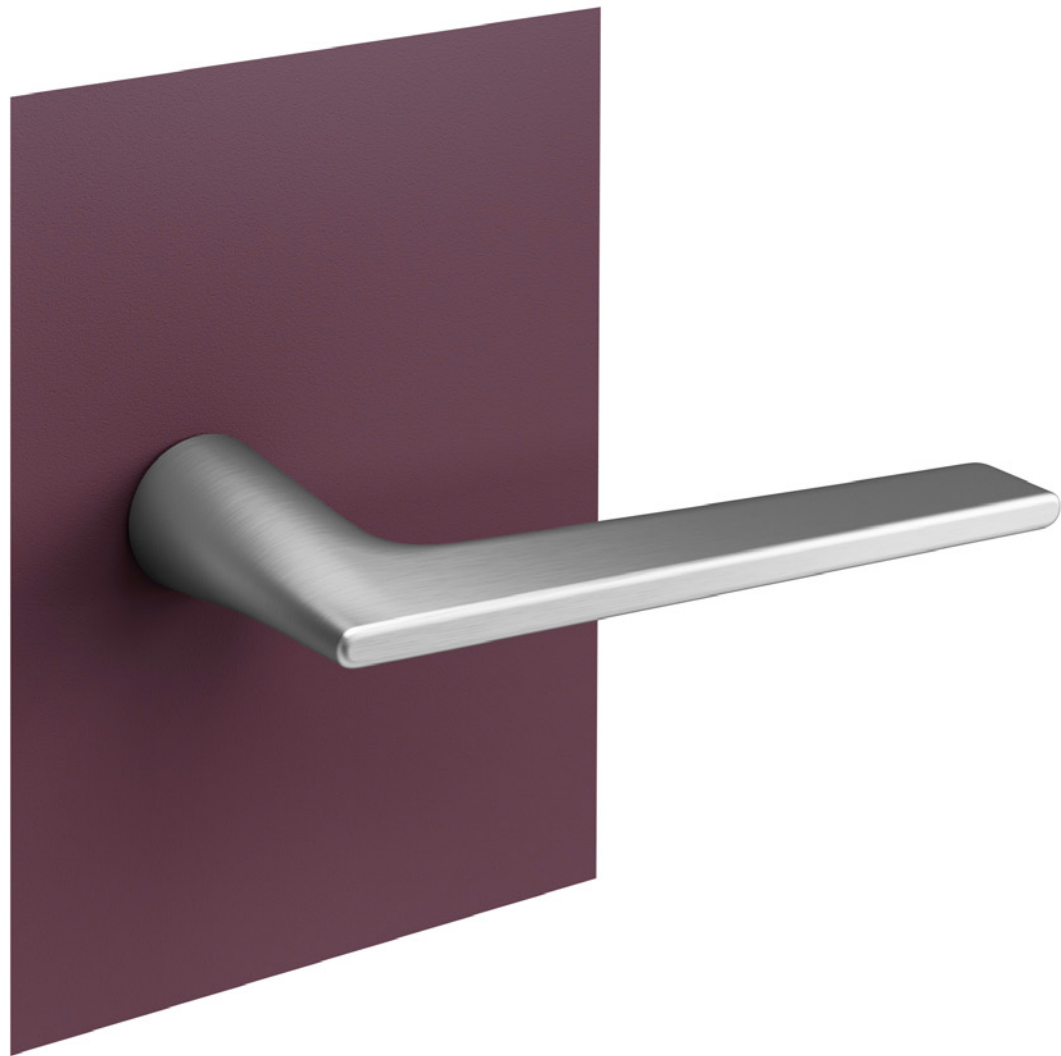

design Alessandro Stabile

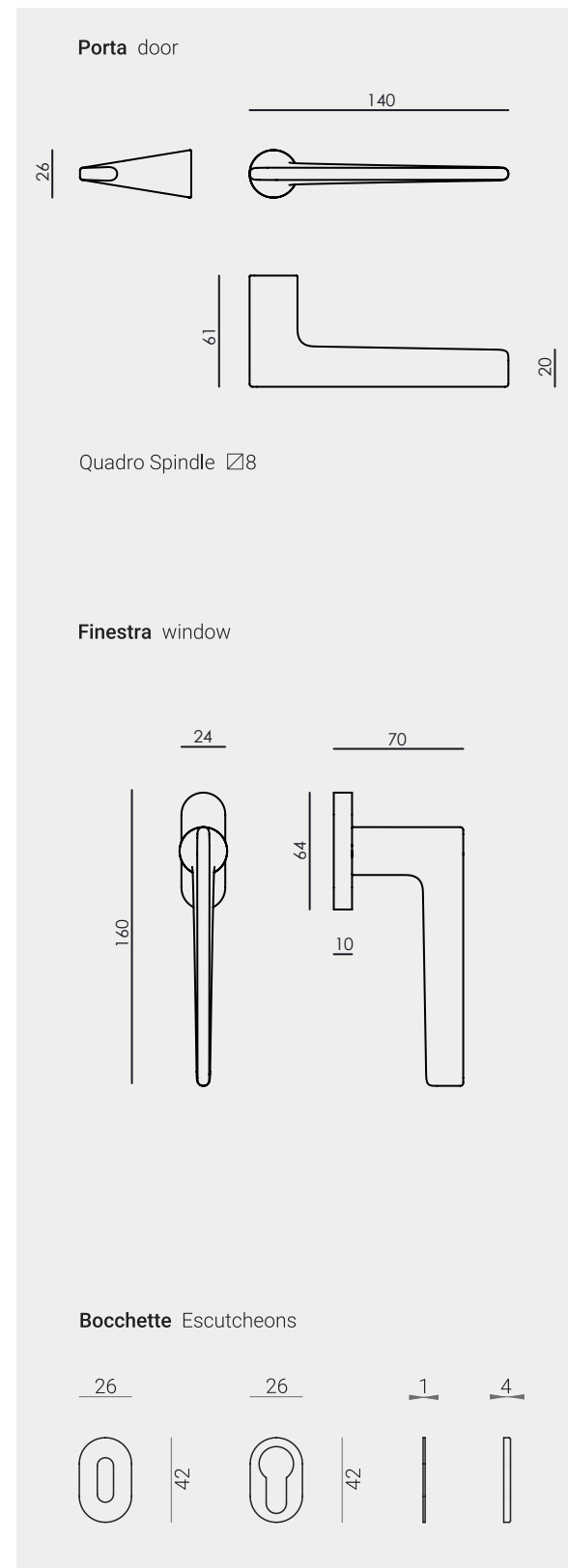

Cod. 127005  
 Materiale Zama / Material Zamak



## FINITURE FINISHES

-  **Cromo Satinato**  
Satin Chrome
-  **Nero Etna**  
Etna Black
-  **Bianco Monviso**  
Monviso White

# Pepe

design Alessandro Stabile

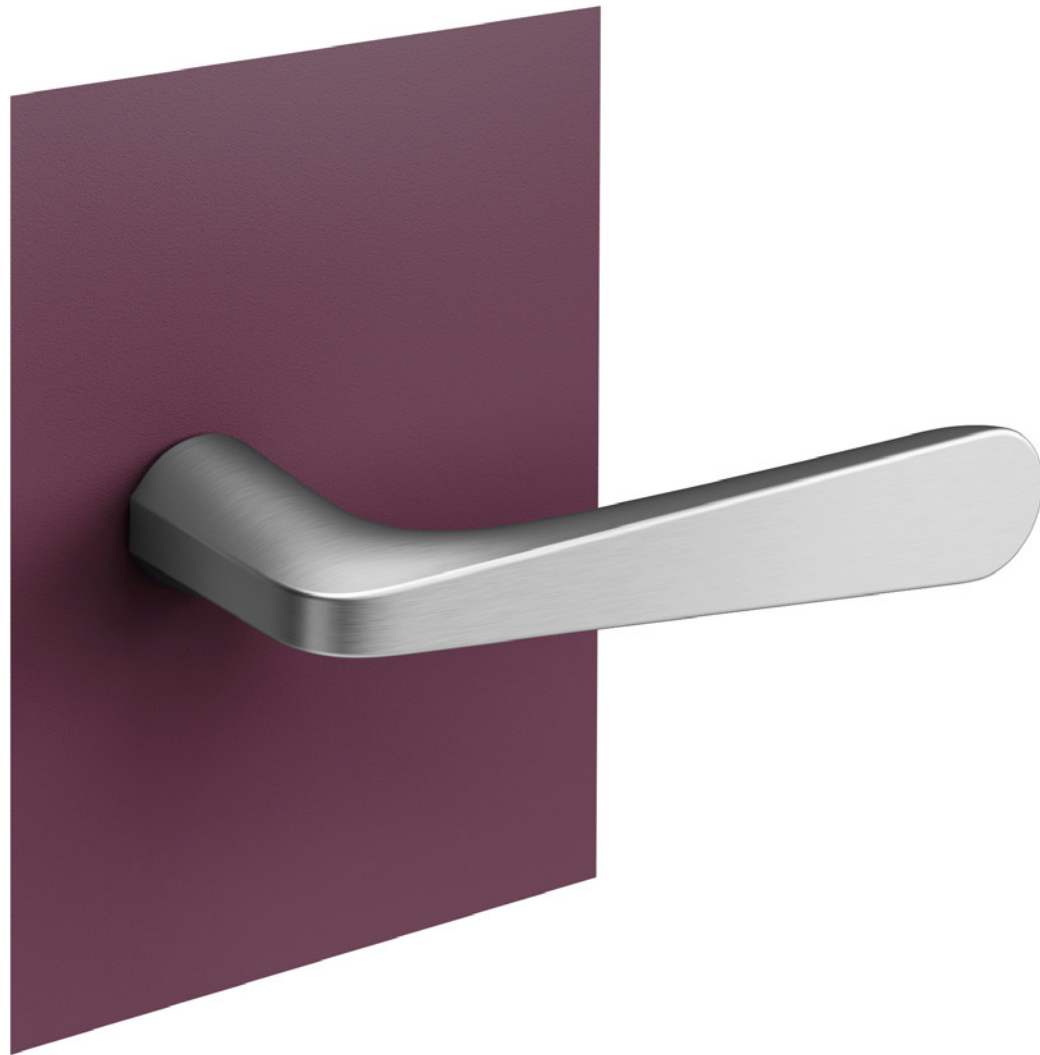

Cod. 127007  
Materiale Zama / Material Zamak

## Porta door

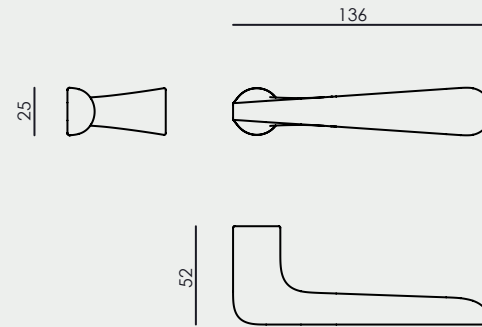

## Quadro Spindle $\square 8$

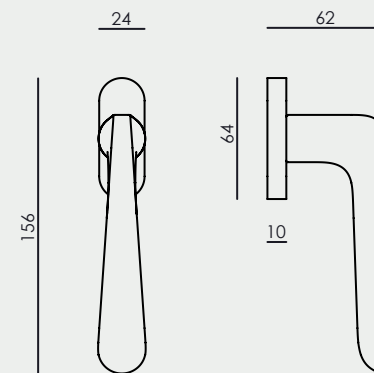

## Finestra window

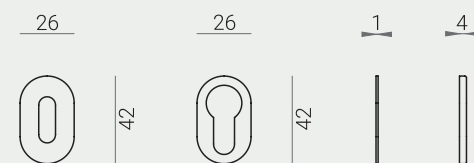

## Bocchette Escutcheons



## FINITURE FINISHES

-  **Cromo Satinato**  
Satin Chrome
-  **Nero Etna**  
Etna Black
-  **Bianco Monviso**  
Monviso White



# Wind

design Mattia Ferremi

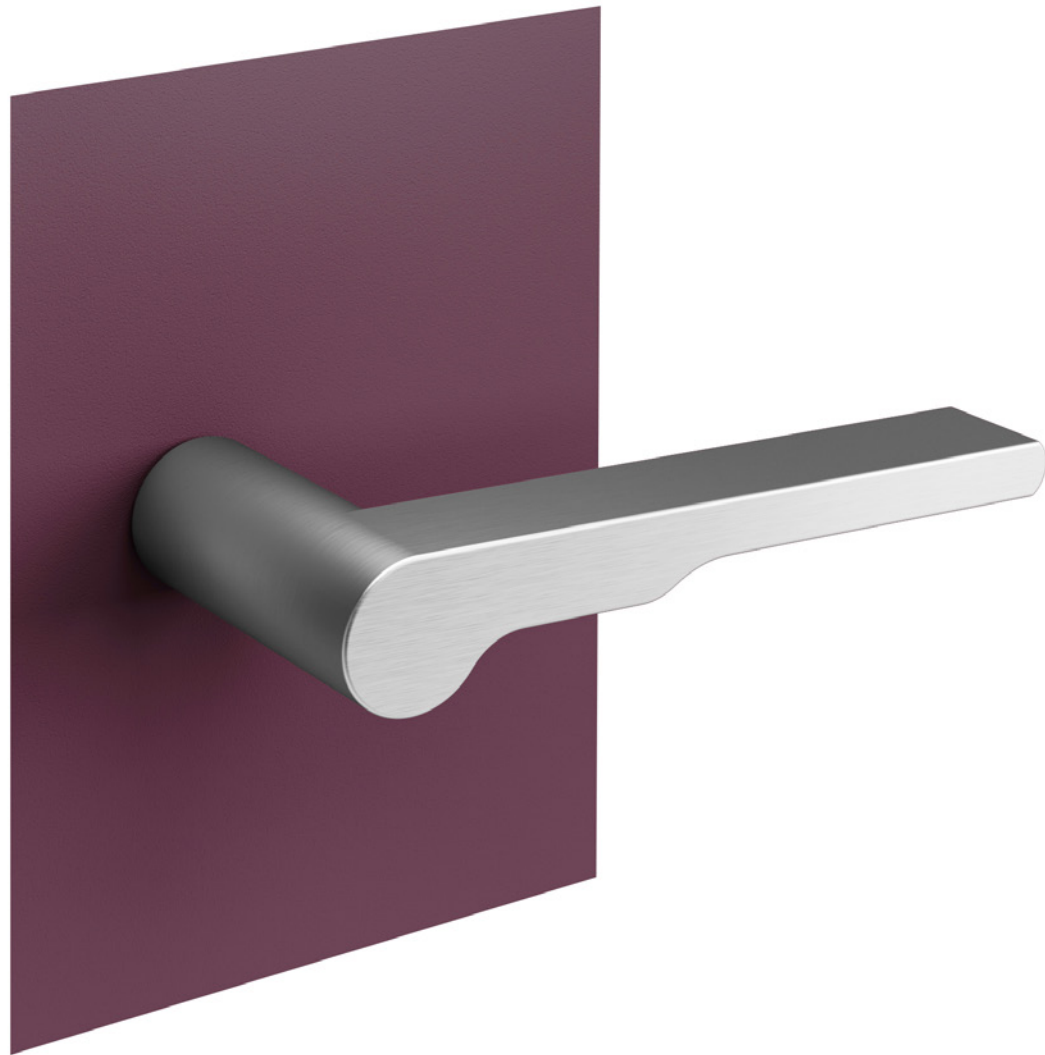

**Cod. 127002**  
**Materiale Zama / Material Zamak**

## Porta door

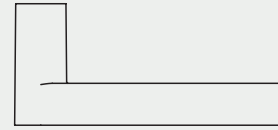
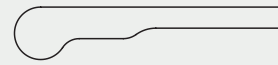

58

130

Quadro Spindle  $\square 8$

## Finestra window

24

68

10



150

64

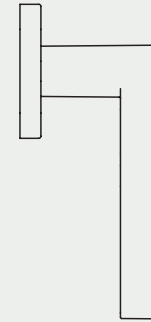

## Bocchette Escutcheons

26

26

1

4



42



42



## FINITURE FINISHES



**Cromo Satinato**  
Satin Chrome



**Cromo Lucido**  
Polished Chrome



**Nero Etna**  
Etna Black



**Bianco Monviso**  
Monviso White



**Bronzo Yester**  
Yester Bronze

# Atlanta

design Nuda R&D

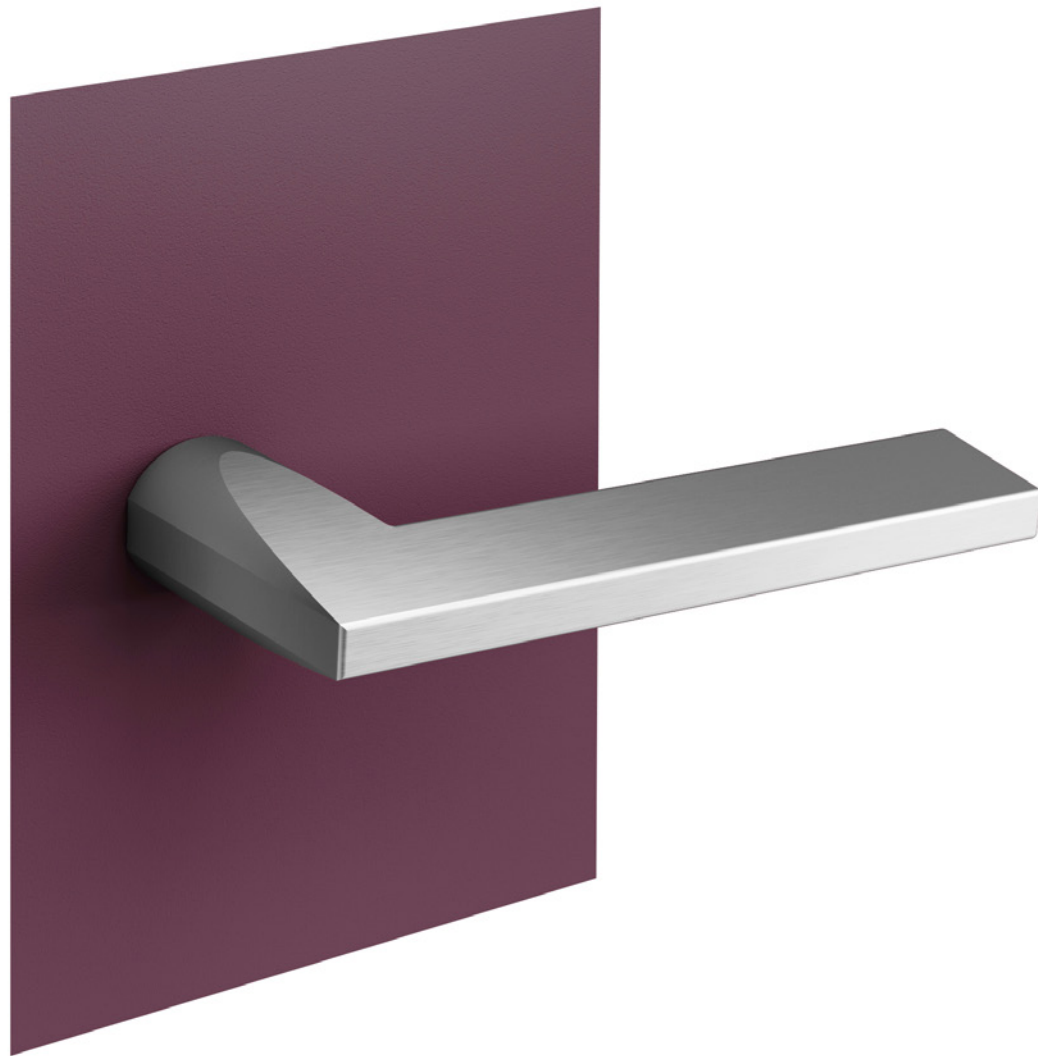

**Cod. 127003**  
**Materiale Zama / Material Zamak**

## Porta door

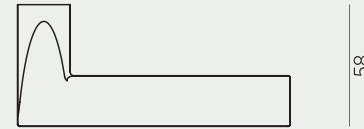
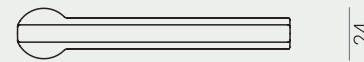

130

Quadro Spindle  $\square 8$



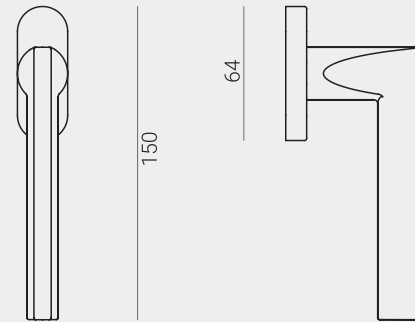
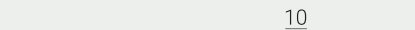
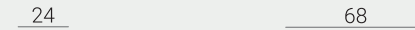

## Finestra window

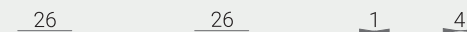

## Bocchette Escutcheons



## FINITURE FINISHES

-  **Cromo Satinato**  
Satin Chrome
-  **Cromo Lucido**  
Polished Chrome
-  **Nero Etna**  
Etna Black
-  **Bianco Monviso**  
Monviso White
-  **Bronzo Yester**  
Yester Bronze

# Lui

design Alessandro Stabile

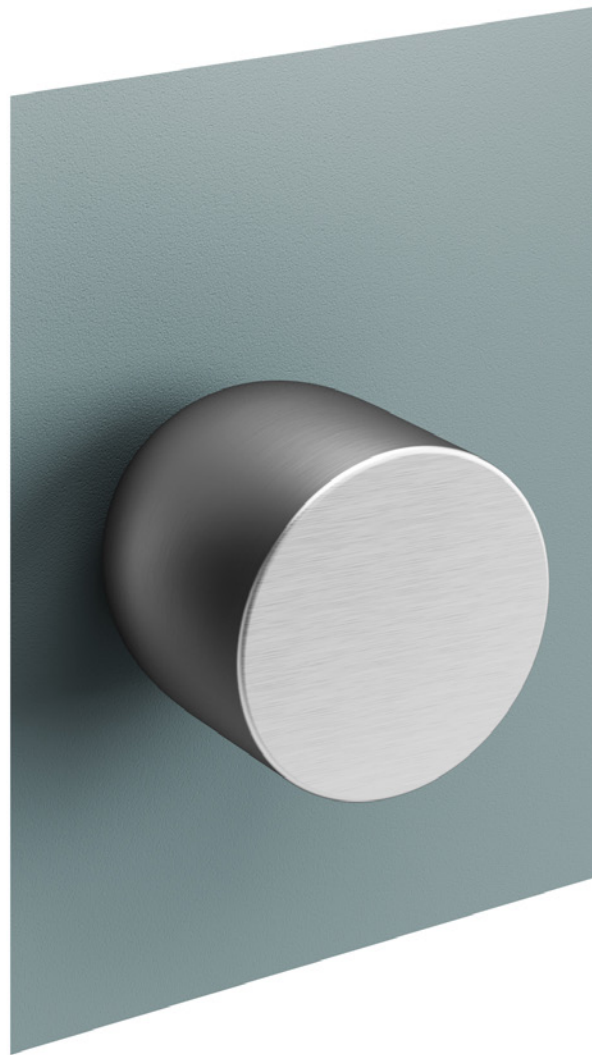

Cod. 127004

Materiale Alluminio / Material Aluminium

## Set pomoli girevoli Turnable knob set

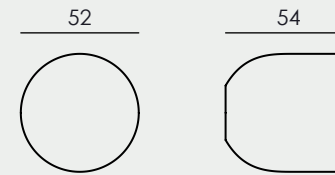

Quadro Spindle  $\square 8$

Disponibili anche  
Also available

## Set pomolo fisso singolo Single fixed knob set

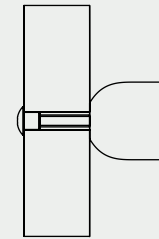

## Set pomolo fisso doppio Double fixed knob set

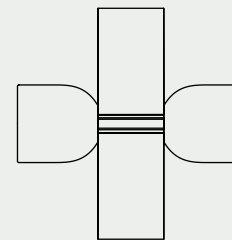

Bocchette Escutcheons

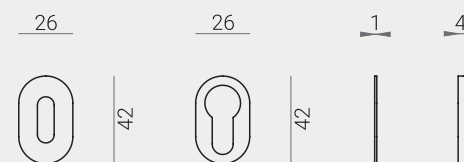

## FINITURE FINISHES

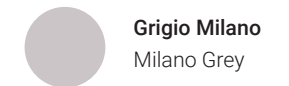

**Grigio Milano**  
Milano Grey



**Nero Etna**  
Etna Black



**Bianco Monviso**  
Monviso White

# Cham

design Nuda R&D



Cod. 127008

Materiale Alluminio / Material Aluminium

## Set pomoli girevoli Turnable knob set

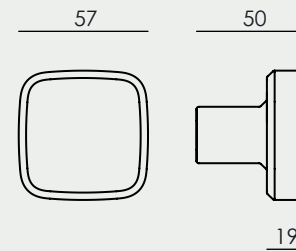

Quadro Spindle  $\square 8$

## Disponibili anche Also available

### Set pomolo fisso singolo Single fixed knob set

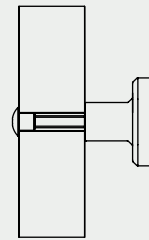

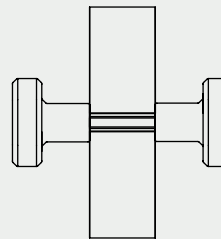

### Set pomolo fisso doppio Double fixed knob set



## Bocchette Escutcheons



## FINITURE FINISHES

-  **Grigio Milano**  
Milano Grey
-  **Nero Etna**  
Etna Black
-  **Bianco Monviso**  
Monviso White

# Soap

design Nuda R&D

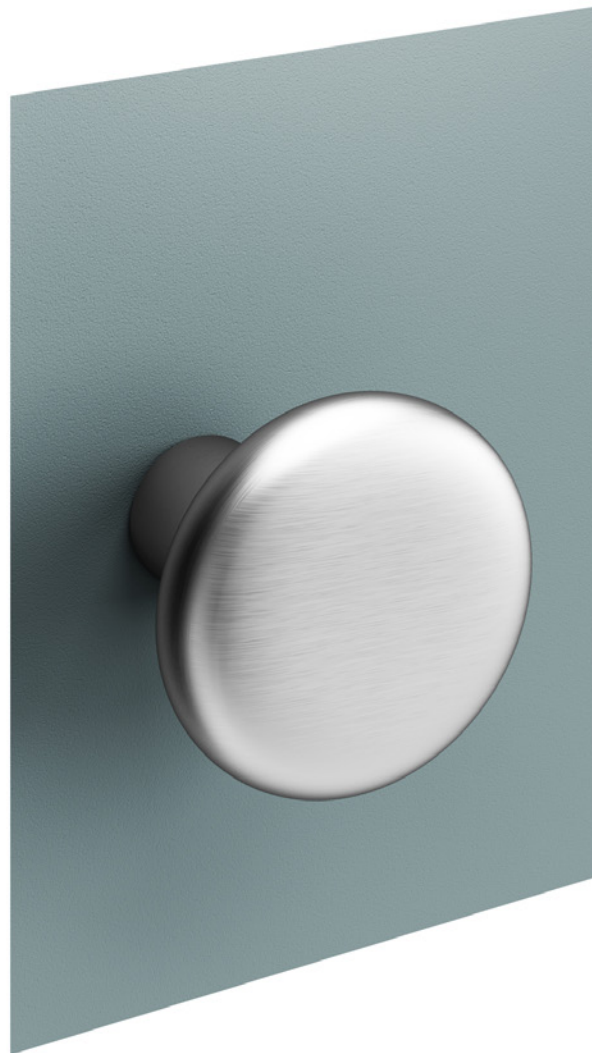

Cod. 127009

Materiale Alluminio / Material Aluminium

## Set pomoli girevoli Turnable knob set

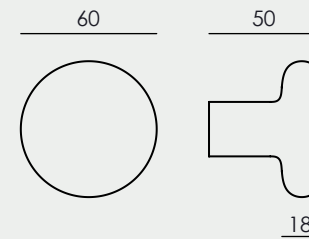

Quadro Spindle  $\square 8$

## Disponibili anche Also available

### Set pomolo fisso singolo Single fixed knob set

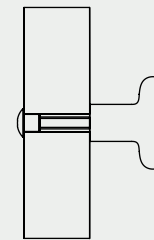

### Set pomolo fisso doppio Double fixed knob set

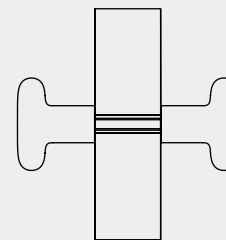

## Bocchette Escutcheons



## FINITURE FINISHES

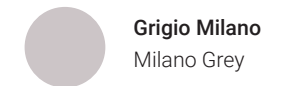

**Grigio Milano**  
Milano Grey



**Nero Etna**  
Etna Black



**Bianco Monviso**  
Monviso White

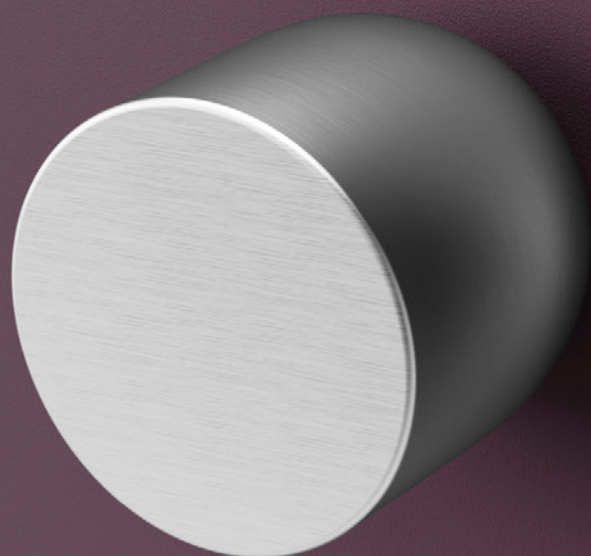

|           |   |
|-----------|---|
| <b>28</b> | <b>NOTTOLINO</b><br>Privacy Set             |
| <b>30</b> | <b>FINESTRA</b><br>Window                   |
| <b>34</b> | <b>ACCESSORI</b><br>Accessories             |
| <b>35</b> | <b>SERRATURE</b><br>Locks                   |
| <b>36</b> | <b>FORATURA PORTA</b><br>Door Drilling      |
| <b>38</b> | <b>FINITURE</b><br>Finishes                 |
| <b>40</b> | <b>CONDIZIONI DI VENDITA</b><br>Sales Terms |



## Nottolino Privacy set

Nuda offre dei nottolini dedicati da abbinare al design delle proprie maniglie per avere una continuità di immagine. Il nottolino diviene elemento tecnico, funzionale ed estetico al contempo.

Nuda offers privacy sets to be specifically matched to the design of the handles and have a continuity in terms of image. The privacy set becomes a technical, functional and aesthetic element at the same time.

### Nottolino Punto può essere abbinato a tutte le maniglie della collezione Nuda.

Punto privacy set can be easily combined to every handle and knob of Nuda collection.

Spessore pannello tra 40 e 60mm  
Panel thickness 40-60mm

Quadro Spindle 6

Cod.128015

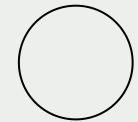
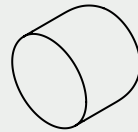

27



23

**Materiale Zama** Material Zamak

**Finiture** Finishes

**Cromo satinato** Satin chrome

**Cromo lucido** Polished chrome

**Bianco Monviso** Monviso white

**Nero Etna** Etna black

**Bronzo yester** Yester bronze

**Grigio Milano** Milano Grey



**Nottolino per maniglia Pure e Wind**  
Privacy set for Pure and Wind handle

Spessore pannello tra 40 e 60 mm  
Panel thickness 40-60 mm

Quadro Spindle  $\square 6$

Cod. 128006

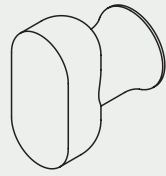

$\varnothing 20$

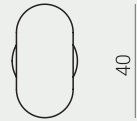

40

33

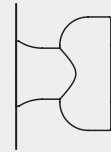

**Nottolino per maniglia Atlanta**  
Privacy set for Atlanta handle

Spessore pannello tra 40 e 60 mm  
Panel thickness 40-60 mm

Quadro Spindle  $\square 6$

Cod. 128007



14



40

33

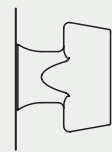





## Finestra Window

Nuda offre una soluzione di estremo minimalismo anche per la finestra. La maniglia diviene così elemento di sintesi tra porta e finestra.

Nuda offers a solution of extreme minimalism also for the window. The handle becomes a perfect cohesion element between the door and the window.

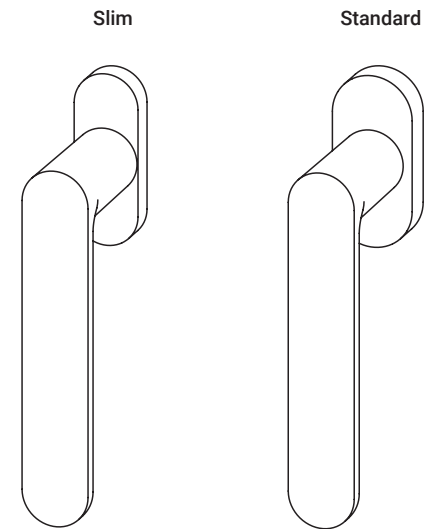

**Materiale Zama** Material Zamak

**Finiture** Finishes

**Cromo satinato** Satin chrome

**Cromo lucido** Polished chrome

**Bianco Monviso** Monviso white

**Nero Etna** Etna black

**Bronzo yester** Yester bronze

### Slim 4 movimenti Slim 4 movements

24



152

Pure  
Cod. 129001

Wind  
Cod. 129002

Atlanta  
Cod. 129003

Lieve  
Cod. 129005

Baar  
Cod. 129006

Pepe  
Cod. 129007

### Standard 4 movimenti Standard 4 movements

30



152

Pure  
Cod. 129201

Wind  
Cod. 129202

Atlanta  
Cod. 129203

Lieve  
Cod. 129205

Baar  
Cod. 129206

Pepe  
Cod. 129207

## Accessori Accessories

### 1. Bocchette Escutcheons

#### A. Bocchetta Slim Slim escutcheon

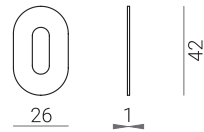

**Foro Chiave**  
Key hole  
Cod. 128002

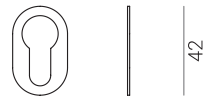

**Foro Cilindro**  
Cylinder hole  
Cod. 128005

#### B. Bocchette Standard Standard escutcheon

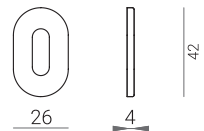

**Foro Chiave**  
Key hole  
Cod. 128001

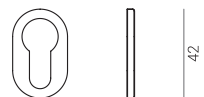

**Foro Cilindro**  
Cylinder hole  
Cod. 128004

#### C. Rondella diametro 30 mm 30 mm diameter washer

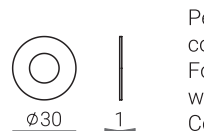

Per pannelli preforati  
con diametro fino a 25 mm  
For predrilled panels  
with a diameter up to 25 mm  
Cod. 128009

#### D. Bocchetta slim diametro 30 mm per foro chiave Slim key hole escutcheon diameter 30 mm



Da abbinare a rondella  
diametro 30 mm - Art 128009  
To be matched with 30 mm  
diameter washer - Art 128009  
Cod. 128010

#### E. Rondella diametro 24 mm 24 mm diameter washer



Per pannelli preforati  
con diametro fino a 20 mm  
For predrilled panels  
with a diameter up to 20 mm  
Cod. 128008

### 2. Quadri Spindles

Le maniglie della collezione Nuda vengono fornite con un quadro con fissaggio a due grani per porte di spessore compreso tra i 40 e 60 mm. Su richiesta è possibile realizzare quadri di lunghezza differente.

Per il mondo dell'industria, è possibile richiedere un quadro premontato di lunghezza desiderata con fissaggio a un solo grano.

Nuda handles come as standard with a spindle with 2 fixing grains for 40-60 mm thickness doors. On demand, it is also possible to provide spindles of different lengths.

For the industry sector, Nuda handles can be provided with preassembled spindles of desired length with a single fixing grain.

## Serrature Locks

**Serrature magnetiche** Magnetic locks  
Cod. 180

**Serrature meccaniche** Mechanical locks  
Cod. 183

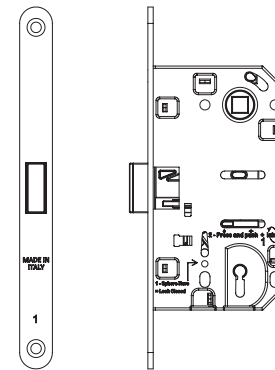

**Foro chiave**  
Key hole

Cod. 004

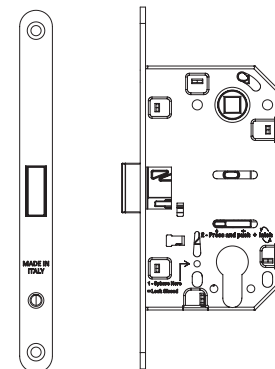

**Foro cilindro**  
Cylinder hole

Cod. 005

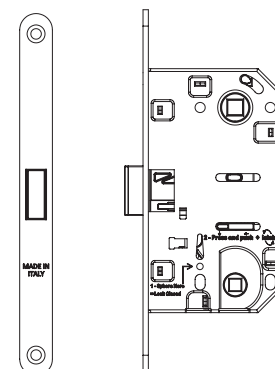

**Foro nottolino**  
Privacy set hole

Cod. 006

## Incontri Striking plates

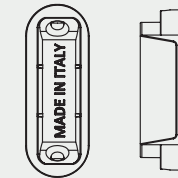

**Incontro per serratura magnetica**  
Striking plate for magnetic lock  
Cod. 181001

**Incontro per serratura meccanica**  
Striking plate for mechanical lock  
Cod. 184005

**Materiale Abs** Material Abs

**Finiture** Finishes

**Cromo satinato** Satin chrome  
**Bianco Monviso** Monviso white  
**Nero Etna** Etna black  
**Bronzo yester** Yester bronze

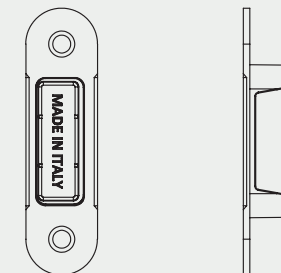

**Incontro con piastrina per serratura magnetica**  
Striking plate with platelet for magnetic lock  
Cod. 181003

**Incontro con piastrina per serratura meccanica**  
Striking plate with platelet for mechanical lock  
Cod. 184004

**Materiale Abs e metallo** Material Abs and metal

**Finiture** Finishes

**Cromo satinato** Satin chrome  
**Cromo lucido** Polished chrome  
**Bianco Monviso** Monviso white  
**Nero Etna** Etna black  
**Bronzo yester** Yester bronze

## Foratura porta Door drilling

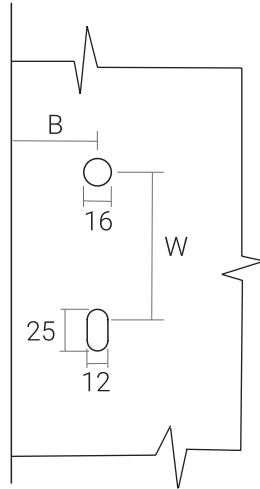
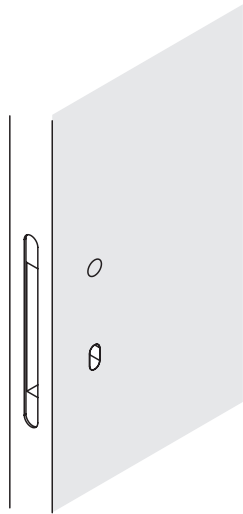

**Maniglia con bocchetta foro chiave standard e slim.  
Set pomoli girevoli con bocchetta foro chiave standard o slim.**

Handle with standard or slim key hole escutcheon.  
Turnable knob set with standard or slim key hole escutcheon.

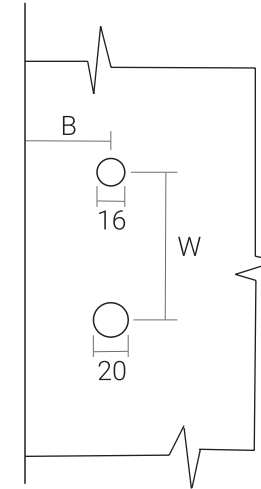
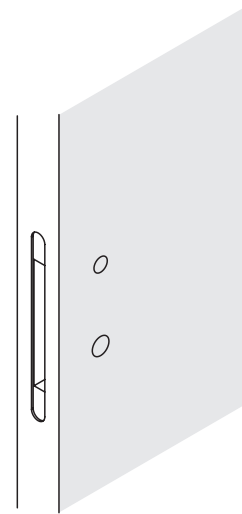

**Maniglia con nottolino.  
Set pomoli girevoli con nottolino.**

Handle with privacy.  
Turnable knob set with privacy set.

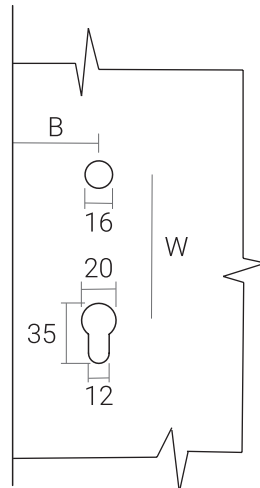
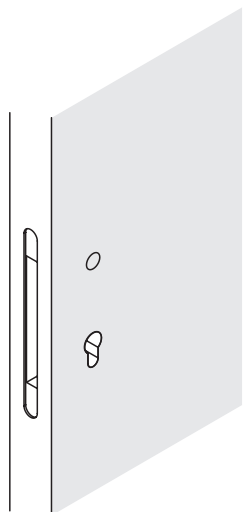

**Maniglia con bocchetta foro cilindro standard e slim.  
Set pomoli girevoli con bocchetta foro cilindro standard o slim.**

Handle with standard or slim cylinder hole escutcheon.  
Turnable knob set with standard or slim cylinder hole escutcheon.

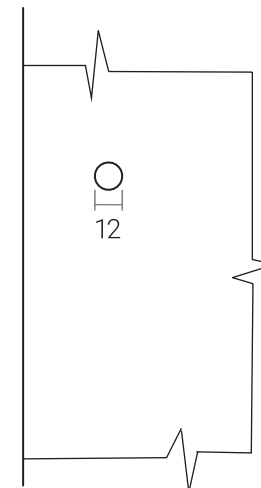
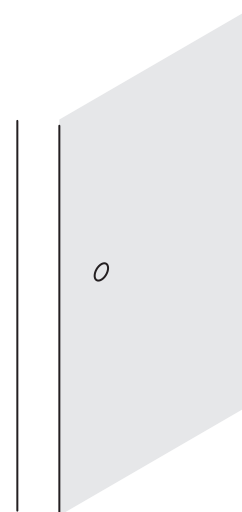

**Pomolo fisso singolo/ doppio**

Fixed single/ double knob set

## Finiture Finishes

**Cod.14**  
**Cromo satinato**  
Satin Chrome



**Cod.18**  
**Nero Etna**  
Etna Black



**Cod.49**  
**Bianco Monviso**  
Monviso White



**Cod.39**  
**Cromo lucido**  
Polished Chrome



**Cod.21**  
**Bronzo Yester**  
Yester Bronze



**Cod.80**  
**Grigio Milano**  
Milano Grey

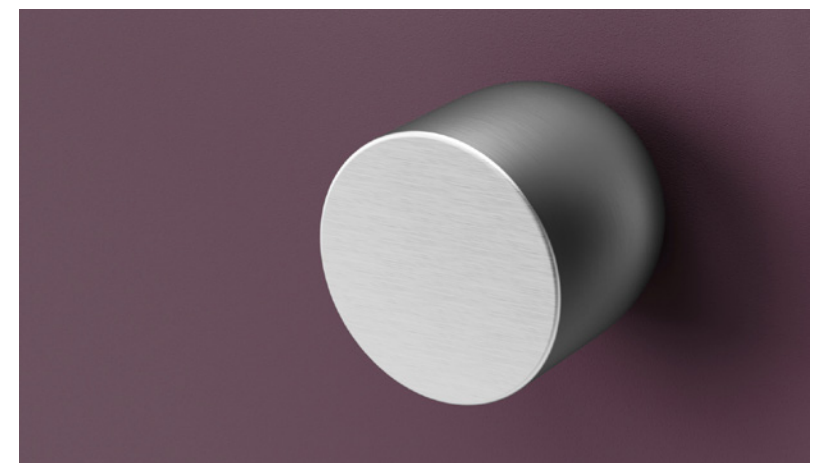

**Finiture speciali su richiesta**  
Special finishes on demand



## CONDIZIONI GENERALI DI VENDITA

### MODELLI, DIMENSIONI, PESI

Verum Italy si riserva, in qualunque momento e senza preavviso, di modificare e/o sopprimere gli articoli del presente catalogo. Dati, misure o schemi su questo catalogo hanno solamente carattere informativo, non sono vincolanti e possono essere soggetti a variazioni.

### ORDINI

Verranno accettati solo ordini per iscritto; ordini pervenuti telefonicamente o verbalmente non saranno ritenuti validi. Con la trasmissione dell'ordine il cliente accetta tutte le condizioni elencate di seguito. L'ordine è vincolante per il cliente, mentre impegna Verum Italy srl solo dopo espressa accettazione. Non possono essere effettuati annullamenti senza l'accordo scritto di Verum Italy, che si riserva comunque di applicare oneri e spese che ne derivino.

### TERMINI DI CONSEGNA

I tempi di consegna dell'ordine decorrono dalla data della nostra conferma salvo diversa stipulazione e non potranno in nessun luogo dare luogo ad indennizzo/risarcimento da parte di Verum Italy. I termini di consegna indicati nell'ordine sono da intendersi puramente indicativi e non vincolanti per Verum Italy, che non sarà responsabile di eventuali ritardi. In particolare non è responsabile per ritardata o omessa consegna, totale o parziale, imputabile a cause di forza maggiore, o ad eventi che siano fuori dal suo controllo, quali, in via esemplificativa, scioperi aziendali e di trasporto, mancanza di energia elettrica, mancata o ritardata ricezione di materie prime, ecc. Verum Italy si riserva il diritto di evadere l'ordine anche con spedizioni parziali.

### DATI IDENTIFICATIVI DEL CLIENTE

Il cliente è responsabile della comunicazione dei propri dati fiscali forniti in base alla legislazione vigente (Ditta, Ragione sociale, Sede, Partita IVA). I dati del cliente saranno custoditi ed elaborati per adempimenti degli obblighi di Legge. Ogni altro utilizzo dovrà essere espressamente autorizzato dal cliente.

### SPEDIZIONI

La merce viaggia a rischio e pericolo del committente franco stabilimento Verum Italy o Grip Italia, che declina comunque ogni responsabilità per ritardi o rotture verificatesi durante il trasporto. Spetta al committente verificare la merce in arrivo e contestare eventuali danni direttamente al trasportatore, anche se questi è stato scelto da Verum Italy, entro 8 giorni dal ricevimento della stessa mediante raccomandata A.R. Si accettano eventuali reclami sulla quantità di pezzi ricevuta al massimo entro 8 giorni dalla data di consegna.

### PAGAMENTO

I pagamenti devono essere effettuati direttamente a Verum Italy nei termini pattuiti. Trascorsi i termini Verum

Italy provvederà senza alcun preavviso all'addebito degli interessi di mora stabiliti per Legge, che decorreranno dal giorno immediatamente successivo alla scadenza del debito. Il mancato rispetto dei pagamenti pattuiti, comunicati per iscritto nelle conferme d'ordine, può comportare, a discrezione dell'azienda, il blocco degli ordini in corso fino a pagamento avvenuto e la sospensione delle ulteriori forniture anche se già accettate. I pagamenti dei prodotti già consegnati non saranno subordinati al completamento dell'ordine. Nessun pagamento potrà essere differito nel caso di contestazioni salvo accordi diversi. Fino al momento in cui Verum Italy non abbia ricevuto il pagamento del valore complessivo dei prodotti, gli stessi rimarranno di esclusiva proprietà di Verum Italy.

### RESPONSABILITÀ

Non si accettano merci di ritorno se non rese in Porto Franco e preventivamente autorizzate da Verum Italy. Solo il materiale riscontrato difettoso da Verum Italy sarà sostituito gratuitamente senza nessun altro indennizzo per danni, spese o riparazioni. Verum Italy non si assume alcuna responsabilità e alcuna garanzia è prevista per difetti e danni derivanti da installazione impropria o cattivo uso. È vietato agli acquirenti effettuare qualsiasi lavorazione che modifichi le caratteristiche originarie dei prodotti Verum Italy.

### CONTROVERSIE

Le forniture sono soggette alla Legge italiana. NUDA utilizza un sistema brevettato da Grip Italia Srl e ne è vietata la riproduzione o la copia non autorizzata. I trasgressori saranno puniti a norma di legge. Per qualunque controversia è riconosciuta la sola ed esclusiva competenza del Foro di Monza, Italia.

### TERMINI DI GARANZIA

Si certifica che le maniglie della collezione Nuda sono interamente prodotte in Italia nelle nostre aziende. Ogni articolo, stampato o fuso e lavorato a mano è unico ed irripetibile e le piccole differenze cromatiche, che possono riscontrarsi, rappresentano la garanzia più certa dell'artigianalità del prodotto. Eventuali imperfezioni e/o differenze nella forma, nelle finiture e nei materiali sono da attribuire alla tecnologia e/o alle operazioni manuali necessarie alla lavorazione del prodotto. L'inosservanza delle istruzioni di montaggio e/o una non cura nell'utilizzo possono causare il mal funzionamento del sistema, per i quali si declina ogni responsabilità.

### CONSIGLI PER LA PULIZIA, LA CURA E LA MANUTENZIONE DEL PRODOTTO

Si consiglia di pulire le maniglie della collezione Nuda utilizzando solamente un panno asciutto o leggermente inumidito con acqua. Non utilizzare assolutamente alcun detergente chimico per non alterare l'efficacia del trattamento superficiale.

## GENERAL SALES TERMS AND CONDITIONS

### MODELS, DIMENSIONS AND WEIGHTS

Verum Italy Srl reserves the right, at any time, to change and/or to cancel the items of this catalogue. Information, size or drawings in this catalogue are only for information and are not binding.

### ORDERS

Orders are accepted only in written form; orders or modifications communicated verbally and/or by phone will not be valid. Customers accept and are aware that their order is subject to the following general sale terms and conditions. Verum Italy Srl is not legally bound by an order until we have confirmed it in written form but the Customer is bound when he/she accepts it. No cancellation of the order is valid without written agreement from Verum Italy Srl, which reserves the right to apply charges.

### DELIVERY TERMS

Delivery time starts from the order confirmation date, unless otherwise agreed, Verum Italy Srl will not recognize any indemnity or compensation. The order delivery terms are purely indicative and not binding for Verum Italy Srl, which is not responsible for any delay. Verum Italy Srl is not liable for delayed or skipped delivery in its totality or partiality, due to acts of God or other event out of its control, like for example labour or freight strikes, lack of electric energy, missed or delayed raw material receipt and so on. Verum Italy Srl reserves the right to dispatch orders even with partial shipment.

### CUSTOMER INFORMATION

The Customer is responsible for all the identification information data requested by the legislation in effect (Company name, legal name, Address, VAT, etc.). All Customer's data will be kept and used in full compliance with the Italian Law. All other use must be specifically allowed by the Customer.

### DELIVERIES

Ordered goods will be at the Customer's risk from the moment of delivery so Verum Italy Srl declines any responsibility for delays or damage caused during the shipment. The Customer is responsible for checking the delivered goods and reporting possible damage to the forwarder, even if chosen by Verum Italy Srl, within 8 (eight) days from receipt by certified mail. The Customer is also responsible for checking the quantity of the delivered goods; claims about quantity will only be accepted within 8 (eight) days from receipt.

### PAYMENTS

Payments shall be made directly to Verum Italy Srl in the manner and at the time agreed by the parties. In the event of failure to make the payment at the due date, the Customer will, with effect from the invoice date, be charged of interests and penalties. If the Customer is in default, Verum Italy Srl shall have the right to defer shipment or any future order intake or delivery until such

default is remedied or said credit re-established to our satisfaction. No claim shall enable the customer to suspend payments. The payment of products already delivered shall not oblige Verum Italy Srl to complete the order. In case of disagreements payments cannot be deferred, unless otherwise agreed. Until the receipt of payment for the total value of the goods ordered, Verum Italy Srl will be and remain the sole and only proprietor of the goods.

### RESPONSIBILITY

Verum Italy Srl does not accept return of goods without prior approval, in all cases costs for goods returns must be borne by the Customer. Only faulty goods found by Verum Italy Srl will be replaced free of charge without any other indemnity or refund for damage or repairs. Verum Italy Srl is not responsible for any faulty goods which have been manipulated in a bad way. Any damage caused by improper installation or use is not covered by any guarantee. Customers are not authorized to rework Verum Italy Srl products.

### CONTROVERSY

Orders are governed by the Italian Law. If the parties cannot reach amicable settlements, disputes shall be referred uniquely to the competent civil court in Monza. NUDA use a patented system of Grip Italia Srl and unauthorized copying or copying is prohibited. Violators will be punished according to the Italian law.

### WARRANTY

We certify with our complete and utmost corporate integrity that the handles of Nuda collection are produced solely within our Italian manufacturing facilities. Each piece of hardware, forged or cast is hand-crafted to perfect the uniqueness in design and finish. The guarantee of originality is due to the fact that the finish of each product is slightly different than the previous item. Any imperfections or differences in form, finishes and materials are to be attributed to the technology or manual operations necessary for processing the product. Failure to comply with the instructions and / or a lack of care in use may cause the system to malfunction, for which the manufacturer declines all responsibility.

### CLEANING SUGGESTIONS

In order to maintain the quality of the protective treatment and uniqueness of all finishes do not attempt to clean with detergents and/or chemicals. Hence, simply use a lightly water moistened cloth to clean the items.

**Verum Italy** è un acceleratore di idee, un'azienda in cui innovazione e ricerca si concretizzano per creare prodotti unici: soluzioni intelligenti per gli spazi abitativi. Verum Italy opera nel mondo del design per offrire al mercato prodotti inediti e rivoluzionari garantendo estetica e funzionalità.

Verum Italy, fondata da Umberto Vergani nel 2012, opera ora in numerosi Paesi del mondo esportando la qualità e l'intelligenza italiana.

**Verum Italy** is an ideas accelerator, a company where innovation and research meet to create unique products: smart solutions for living spaces. Verum Italy operates in the design field to offer to the market original and revolutionary products characterised by design and functionality.

Umberto Vergani established Verum Italy in 2012 and since then has operated worldwide exporting Italian quality and know-how.

### **Verum Italy**

**Strada Statale Briantea, 40  
23892 Bulciago LC  
Italia**

**+39 031 355 9009  
info@verumitaly.it**

Graphic Design: Alessandro Stabile Design Studio

[verumitaly.com/nuda](http://verumitaly.com/nuda)

**VERUM**  
ITALY