



Essential timber

SF-P50 | SF-A60 | SF-P70 | SF-A90 |
SF-RA P50 | SF-RA A60 | SF-RA P70 | SF-RA A90

ESSENTIAL TIMBER

BIBLIOTECA
DE DESCARGAS



DOWNLOADS LIBRARY |
BIBLIOTHÈQUE
TÉLÉCHARGEMENTS

— ES

CREA ESPACIOS CON NUESTRA GAMA DE IMPRESCINDIBLES, LOS BÁSICOS QUE SIEMPRE ESTÁN DE MODA Y TENDENCIA.

Star, una única guía y múltiples opciones para aplicaciones de puertas de paso:

1.Instalación a pared o techo, con perfil visto o a falso techo para un diseño totalmente minimalista. 2.Acabados en aluminio anodizado plata mate y lacado negro y blanco mate para su mejor adaptación a las exigencias arquitectónicas. 3.Diseño liso y elegante. 4.Perfil separador con geometría pensada para ahorrar tiempo en instalación. 5.Solución para paneles de hasta 90Kg. 6.Distintas opciones de rodamiento: a fricción o a bolas, ambas silenciosas y con un mínimo de esfuerzo de deslizamiento. 7.Posibilidad de freno amortiguador (Softbrake) para un cierre suave y sin impactos. 8.Certificado de calidad Applus según la norma EN 1527.

— EN

CREATE SPACES WITH OUR RANGE OF ESSENTIALS, THE BASICS THAT ARE ALWAYS TRENDY.

Star, a single track with multiple options for doorway applications:

1.Wall or ceiling installation, using an exposed or false ceiling concealed track for an entirely minimalist design. 2.Satin anodized aluminum and matt black or white lacquered finishes for a better adaptation to architectural requirements. 3.Smooth and elegant design. 4.Wall mounting profile designed to save installation time. 5.Solution for panels up to 90Kg. 6.Various rolling options: friction or ball bearing, both silent and effortless sliding. 7.Soft closing feature available for a soft and impact-free closing. 8.Applus quality certificate according to EN 1527 standard.

— FR

CRÉEZ DES ESPACES AVEC NOTRE GAMME D'INCONTOURNABLES, LES BASIQUES TOUJOURS TENDANCE.

Star, un seul rail avec plusieurs options pour les applications de portes coulissantes intérieures:

1.Installation en applique au plafond ou au mur avec une profil visible, ou installation avec rail encastrée dans le faux plafond. 2.Finitions en aluminium anodisé argent et laquée noir mat ou blanc pour une meilleure adaptation aux exigences architecturales. 3.Design lisse et élégant. 4.Rail support mural conçu pour gagner du temps d'installation. 5.Solution pour panneaux jusqu'à 90Kg. 6.Différentes options de roulement: roulement à billes ou à friction, à la fois silencieux et avec un effort de coulissement minime. 7.Fermeture en douceur (Amortisseur) disponible pour une fermeture douce et sans impact. 8.Certificat de qualité Applus selon EN 1527.

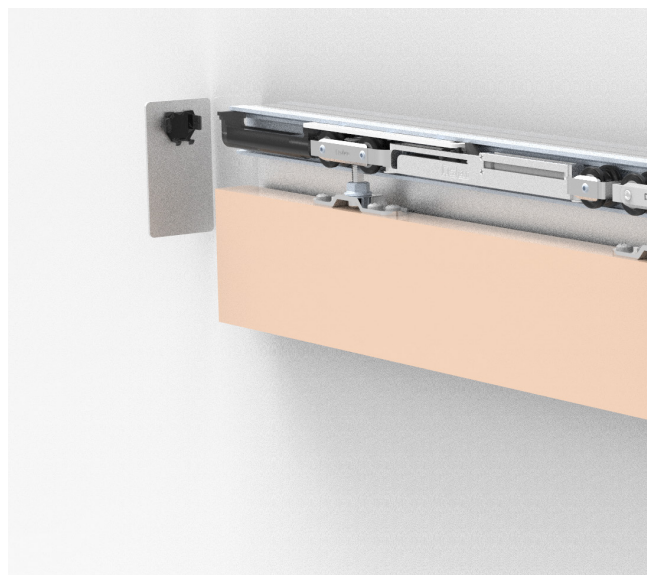
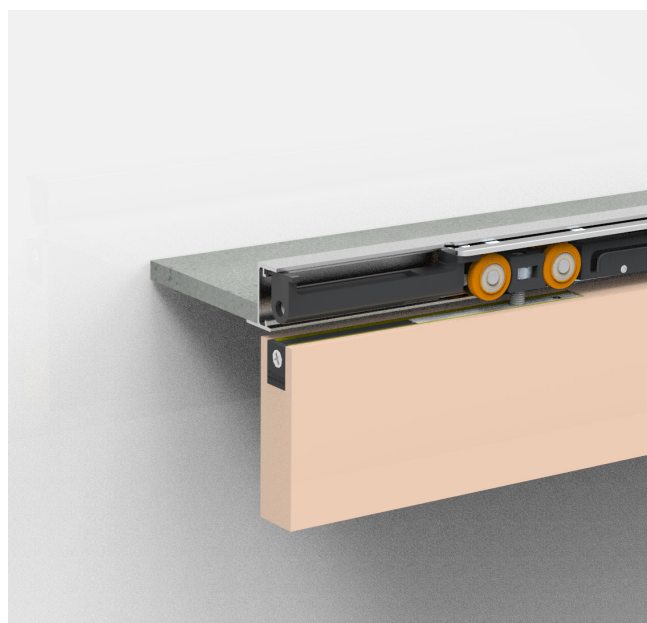
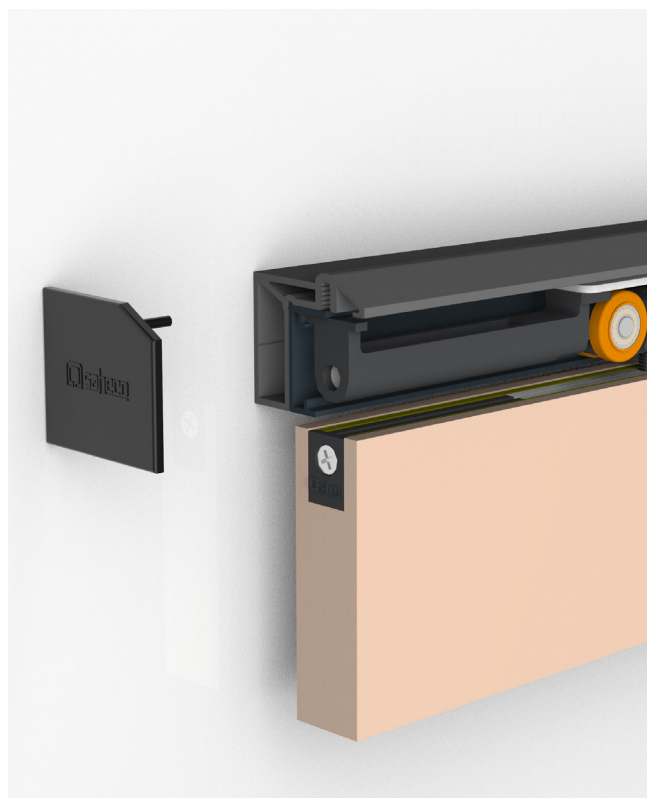

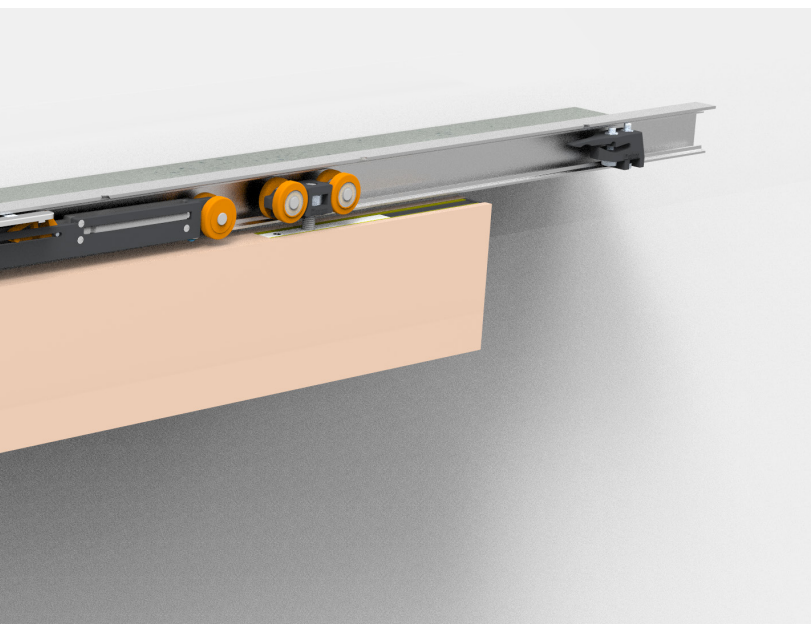
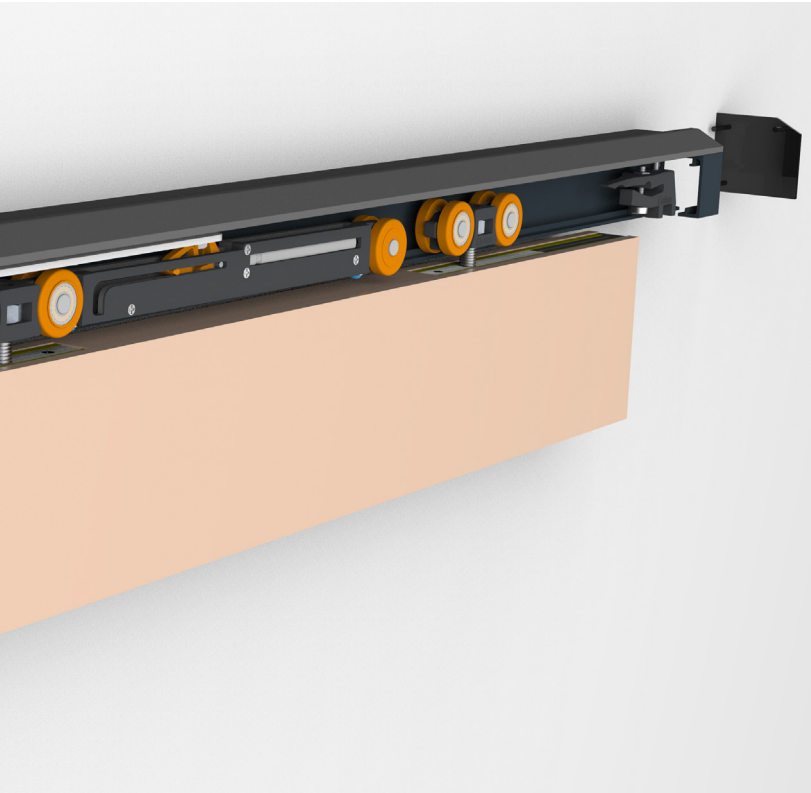

Características técnicas

Technical characteristics | Caractéristiques techniques

Perfilería Profiles | Profils

STANDARD



30x29 mm
No softbrake
I Amortisseur

EXCELLENCE



33x33 mm

STAR



33x32 mm

STAR FT



53x32 mm

SEPARADOR I
SEPARATOR I
SÉPARATEUR
STAR / EXCELLENCE



49x43 mm

Especificaciones Specifications | Spécification



MÍN. 600 mm

SF-P70 I
SF-RA P70



2 Softbrakes
MÍN. 800 mm

SF-A90



2 Softbrakes
MÍN. 825 mm

SF-RA A90



1 Softbrake
MÍN. 615 mm
2 Softbrakes
MÍN. 850 mm



MÍN. 27 mm



SOFTBRAKE
MÁX.90Kg



KIT DISPONIBLE
I AVAILABLE



RODAMIENTO A BOLAS
BALL BEARING
ROULEMENT À BILLES

Peso Weight | Poids

50 kg	110 lb
60 kg	132 lb
70 kg	154 lb
90 kg	198 lb

Producto certificado

Certificated product | Produit certifié





Variantes de instalación

Installation possibilities | Variantes d'installation

PARED | **WALL** | **MUR**

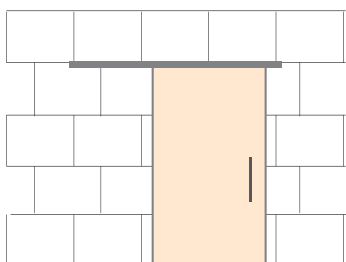

TECHO | **CEILING** | **PLAFOND**

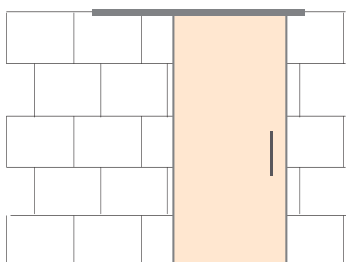

FALSO TECHO | **FALSE** **CEILING** | **FAUX-PLAFOND**

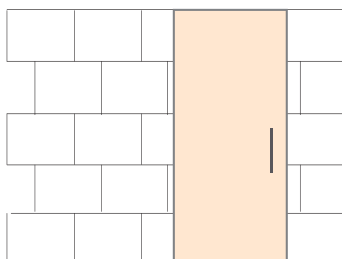



Sección tipo

Cross-section | Section type (Cotas en mm | Dimensions in mm | Dimensions en mm)

MONTAJE A TECHO | CEILING MOUNTING | FIXATION À PLAFOND



STANDARD
No softbrake
I Amortisseur



EXCELLENCE

OPCIÓN PLETINA
PLATE OPTION | OPTION PLATINE

OPCIÓN RA
RA OPTION | OPTION RA

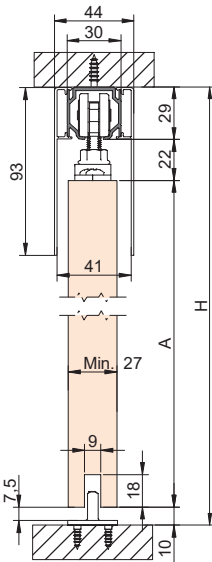
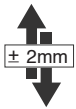

STANDARD
A= H-61

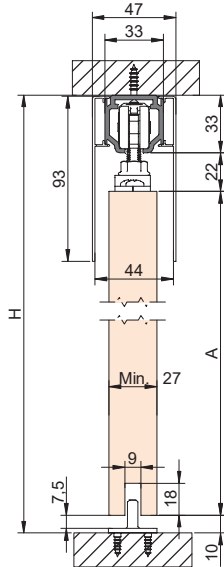

EXCELLENCE
A= H-65

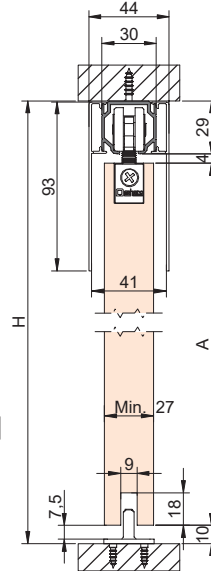
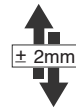

STANDARD
A= H-43

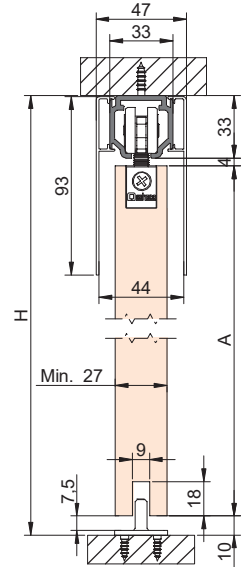

EXCELLENCE
A= H-47



STAR

OPCIÓN PLETINA
PLATE OPTION | OPTION PLATINE

OPCIÓN RA
RA OPTION | OPTION RA

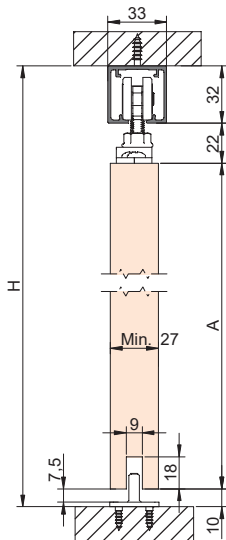
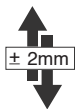

A= H-65

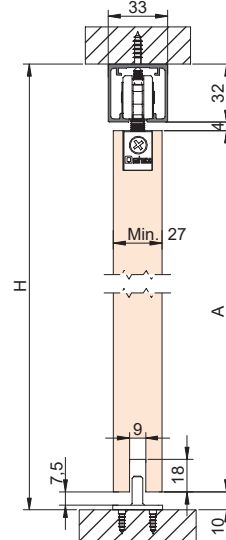
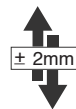

A= H-47

Sección tipo

Cross-section | Section type (Cotas en mm | Dimensions in mm | Dimensions en mm)

MONTAJE A PARED | WALL MOUNTING | FIXATION À MUR

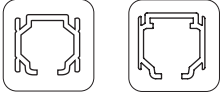

OPCIÓN PLETINA
 PLATE OPTION | OPTION PLATINE

OPCIÓN RA
 RA OPTION | OPTION RA

STANDARD **EXCELLENCE**
 No softbrake
 | Amortisseur

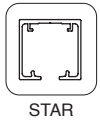
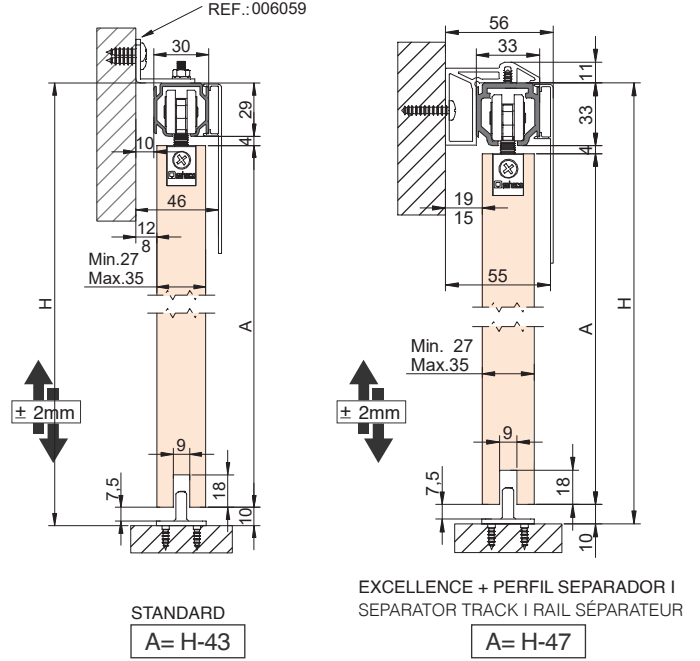
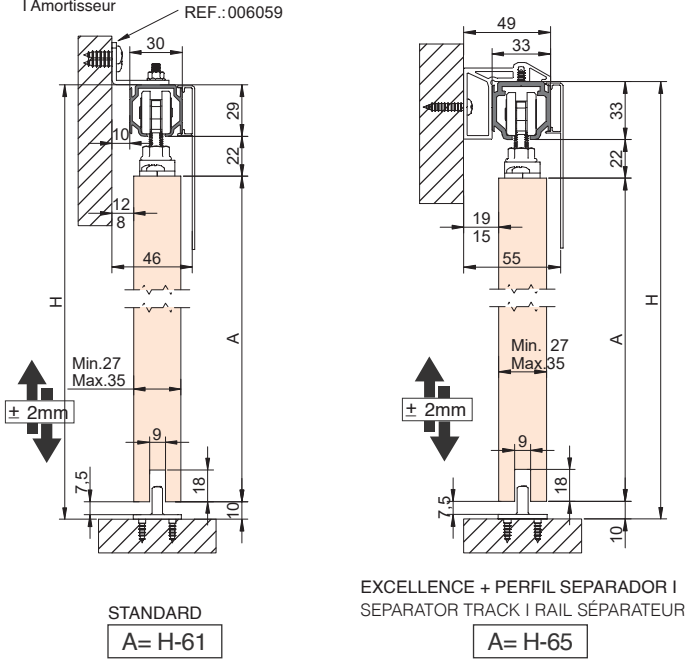

OPCIÓN PLETINA
 PLATE OPTION | OPTION PLATINE

OPCIÓN RA
 RA OPTION | OPTION RA

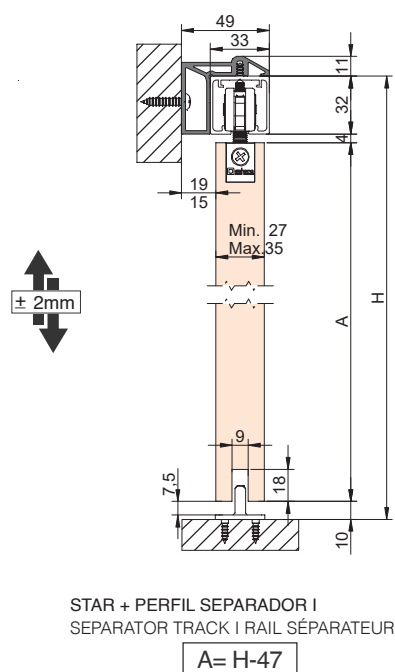
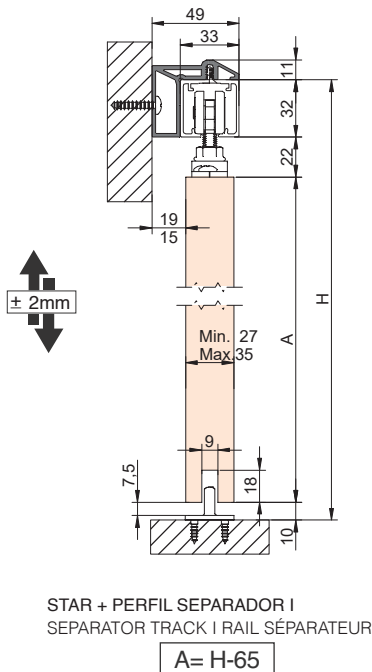



Sección tipo

Cross-section | Section type (Cotas en mm | Dimensions in mm | Dimensions en mm)

MONTAJE A FALSO TECHO | FALSE CEILING MOUNTING | FIXATION À FAUX-PLAFOND



STAR FT

OPCIÓN PLETINA
PLATE OPTION | OPTION PLATINE

OPCIÓN RA
RA OPTION | OPTION RA

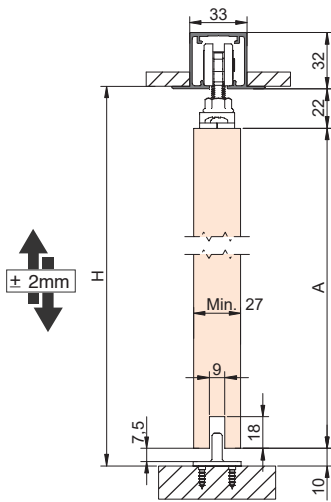

A = H - 32

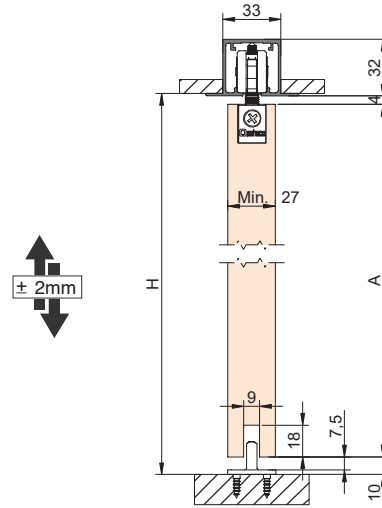

A = H - 14

Componentes

Components | Composants

PERFILERÍA PROFILES PROFILS		Acabado	Cód.	سلسلتا	📦
 <p>Perfil superior Standard Standard top track Rail supérieur Standard</p> <p>80kg  30x29mm No softbrake Amortisseur</p>	<p>80kg</p> <p>30x29mm No softbrake Amortisseur</p>	S	00 60 20 00 60 30 00 60 50	2 m 3 m 5 m	6 perfiles 6 profiles 6 profils
		MF	00 61 20 00 61 30 00 61 50	2 m 3 m 5 m	
 <p>Perfil superior Excellence. Montaje a techo Excellence top track. Ceiling mounting Rail supérieur Excellence. Fixation à plafond</p> <p>90kg  33x33mm</p>	<p>90kg</p> <p>33x33mm</p>	S	0 105 24 0 105 34 0 105 54	2 m 3 m 5 m	2 perfiles 2 profiles 2 profils
		MF	0 105 23 0 105 33 0 105 53	2 m 3 m 5 m	
 <p>Perfil superior Star. Montaje a techo Star top track. Ceiling mounting Rail supérieur Star. Fixation à plafond</p> <p>90kg  33x32mm</p>	<p>90kg</p> <p>33x32mm</p>	S	00 82 20 00 82 30 00 82 50	2 m 3 m 5 m	2 perfiles 2 profiles 2 profils
		MF	00 82 23 ¹ 00 82 33 ¹ 00 82 53 ¹	2 m 3 m 5 m	
 <p>Perfil superior Star FT. Montaje a falso techo Star FT top track. False ceiling mounting Rail supérieur Star FT. Fixation à faux-plafond</p> <p>90kg  53x32mm</p>	<p>90kg</p> <p>53x32mm</p>	S	00 82 25 00 82 35 00 82 55	2 m 3 m 5 m	2 perfiles 2 profiles 2 profils
		BL	00 82 26 00 82 36 00 82 56	2 m 3 m 5 m	
 <p>Perfil superior Star FT. Montaje a falso techo Star FT top track. False ceiling mounting Rail supérieur Star FT. Fixation à faux-plafond</p> <p>90kg  53x32mm</p>	<p>90kg</p> <p>53x32mm</p>	WL	00 82 21 00 82 31 00 82 51	2 m 3 m 5 m	
		BL	00 82 24 00 82 34 00 82 54	2 m 3 m 5 m	
 <p>Perfil superior separador Excellence / Star. Montaje a pared Excellence / Star top separator track. Wall mounting Rail supérieur séparateur Excellence / Star. Fixation à mur</p> <p>90kg  49x43mm</p>	<p>90kg</p> <p>49x43mm</p>	S	00 82 27 ² 00 82 37 ² 00 82 57 ²	2 m 3 m 5 m	1 perfil 1 profile 1 profil
		BL	00 82 28 ² 00 82 38 ² 00 82 58 ²	2 m 3 m 5 m	

¹ Se sirve sin mecanizar | Is served without machining | Est servi sans usinage

² Para perfil superior separador Star / Excellence. Montaje a pared de 2 m, 3 m, 5 m | *For Star / Excellence fixing profile. Wall mounting 2m, 3m or 5m | *Pour profil supérieur séparateur Star / Excellence. Fixation à mur 2m, 3m or 5m. **2 m** - 10 tornillos | screw | vis **3 m** - 15 tornillos | screw | vis **5 m** - 25 tornillos | screw | vis



Aluminio anodizado plata mate
Satin anodized aluminium
Aluminium anodisé argent



Aluminio natural
Mill finish aluminium
Aluminium brut



Aluminio lacado negro
Black lacquered aluminium
Aluminium anodisé laqué noir



Aluminio lacado blanco
White lacquered aluminium
Aluminium anodisé laqué blanc





Componentes

Components | Composants

JUEGOS SETS JEUX	Acabado	Cód.		
OPCIÓN PLETINA PLATE OPTION OPTION PLATINE				
 <p>Juego de accesorios SF-P50 pletina sobrepuesta. x2 Freno retenedor SF-P50 Fitting set with face fixed plate. x2 Retaining stopper Garniture SF-P50 avec platine superposée. x2 Frein de retenue</p> <p>50kg</p> 		00 52 00		10 juegos 10 sets 10 jeux
 <p>Juego de accesorios SF-A60 (pletina 00 60 53) SF-A60 Fitting set (plate 00 60 53) Garniture SF-A60 (platine 00 60 53)</p> <p>60kg</p> 		00 61 00		10 juegos 10 sets 10 jeux
 <p>Juego de accesorios SF-A60 (pletina 00 60 60) SF-A61 Fitting set (plate 00 60 60) Garniture SF-A60 (platine 00 60 60)</p> <p>60kg</p> 		00 61 01		10 juegos 10 sets 10 jeux
 <p>Juego de accesorios SF-P70 pletina sobrepuesta. x2 Freno retenedor SF-P70 Fitting set with face fixed mounting plate. x2 Retaining stopper Garniture SF-P70 avec platine superposée. x2 Frein de retenue</p> <p>70kg</p> 		00 72 00		10 juego 10 set 10 jeu
 <p>Juego de accesorios SF-P70. x1 Softbrake + x1 Tope freno retenedor SF-P70 Fitting set. x1 Softbrake + x1 Retaining stopper Garniture SF-P70. x1 Amortisseur + x1 Butée d'arrêt de retenue</p> <p>70kg</p> 		00 72 03		1 juego 1 set 1 jeu
 <p>Juego de accesorios SF-P70. x2 Softbrake SF-P70 Fitting set. x2 Softbrake Garniture SF-P70. x2 Amortisseur</p> <p>70kg</p> 		00 72 01		1 juego 1 set 1 jeu

Componentes

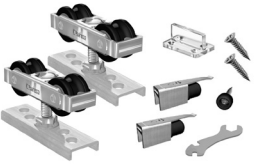
Components | Composants

JUEGOS SETS JEUX		Acabado	Cód.		
 <p>Juego de accesorios SF-A90 (pletina 00 60 53) SF-A90 Fitting set (plate 00 60 53) Garniture SF-A90 (platine 00 60 53)</p> <p>90kg</p> <p>STANDARD EXCELLENCE STAR STAR FT RODAMIENTO A BOLAS MAX.80Kg BALL BEARING ROULEMENT À BILLES</p>			00 81 00		10 juegos 10 sets 10 jeux
 <p>Juego de accesorios SF-A90 (pletina 00 60 60) SF-A90 Fitting set (plate 00 60 60) Garniture SF-A90 (platine 00 60 60)</p> <p>90kg</p> <p>STANDARD EXCELLENCE STAR STAR FT RODAMIENTO A BOLAS MAX.80Kg BALL BEARING ROULEMENT À BILLES</p>			00 81 01		10 juegos 10 sets 10 jeux
 <p>Juego de accesorios SF-A90. x1 Softbrake + x1 Freno retenedor SF-A90 Fitting set. x1 Softbrake + x1 Retaining stopper Garniture SF-A90. x1 Amortisseur + x1 Frein de retenue</p> <p>90kg</p> <p>EXCELLENCE STAR STAR FT RODAMIENTO A BOLAS BALL BEARING ROULEMENT À BILLES</p>			0 981 91		1 juego 1 set 1 jeu
 <p>Juego de accesorios SF-A90. x2 Softbrake SF-A90 Fitting set. x2 Softbrake Garniture SF-A90. x2 Amortisseur</p> <p>90kg</p> <p>EXCELLENCE STAR STAR FT RODAMIENTO A BOLAS BALL BEARING ROULEMENT À BILLES</p>			0 981 90		1 juego 1 set 1 jeu
OPCIÓN RA RA OPTION OPTION RA					
 <p>Juego de accesorios SF-RA P50 (rodamiento a fricción) SF-RA P50 Fitting set (friction bearing) Garniture SF-RA P50 (roulement à friction)</p> <p>50kg</p> <p>STANDARD EXCELLENCE STAR STAR FT</p>			00 52 04		1 juego 1 set 1 jeu
 <p>Juego de accesorios SF-RA60 (rodamiento a fricción) SF-RA60 Fitting set (friction bearing) Garniture SF-RA60 (roulement à friction)</p> <p>60kg</p> <p>STANDARD EXCELLENCE STAR STAR FT</p>			00 60 04		1 juego 1 set 1 jeux



Componentes

Components | Composants

JUEGOS SETS JEUX		Acabado	Cód.		
	<p>Juego de accesorios SF-RA P70 SF-RA P70 Fitting set Garniture SF-RA P70</p> <p>70kg</p> <p>STANDARD EXCELLENCE STAR STAR FT RODAMIENTO A BOLAS BALL BEARING ROULEMENT À BILLES</p>		00 72 11		1 juego 1 set 1 jeux
	<p>Juego de accesorios SF-RA P70. x1 Softbrake + x1 Freno retenedor SF-RA P70 Fitting set. x1 Softbrake + x1 Retaining stopper Garniture SF-RA P70. x1 Amortisseur + x1 Frein de retenue</p> <p>70kg</p> <p>EXCELLENCE STAR STAR FT RODAMIENTO A BOLAS BALL BEARING ROULEMENT À BILLES</p>		00 72 13		1 juego 1 set 1 jeux
	<p>Juego de accesorios SF-RA P70. x2 Softbrake SF-RA P70 Fitting set. x2 Softbrake Garniture SF-RA P70. x2 Amortisseur</p> <p>70kg</p> <p>EXCELLENCE STAR STAR FT RODAMIENTO A BOLAS BALL BEARING ROULEMENT À BILLES</p>		00 72 12		1 juego 1 set 1 jeux
	<p>Juego de accesorios SF-RA A90. x2 Freno retenedor SF-RA A90 Fitting set. x2 Retaining stopper Garniture SF-RA A90. x2 Frein de retenue</p> <p>90kg</p> <p>STANDARD EXCELLENCE STAR STAR FT RODAMIENTO A BOLAS BALL BEARING ROULEMENT À BILLES MÁX.80kg</p>		00 80 04		1 juego 1 set 1 jeu
	<p>Juego de accesorios SF-RA A90. x1 Softbrake + x1 Freno retenedor SF-RA A90 Fitting set. x1 Softbrake + x1 Retaining stopper Garniture SF-RA A90. x1 Amortisseur + x1 Frein de retenue</p> <p>90kg</p> <p>EXCELLENCE STAR STAR FT RODAMIENTO A BOLAS BALL BEARING ROULEMENT À BILLES</p>		0 981 92		1 juego 1 set 1 jeu
	<p>Juego SF-RA A90. x2 Softbrake SF-RA A90 Fitting set. x2 Softbrake Garniture SF-RA A90. x2 Amortisseur</p> <p>90kg</p> <p>EXCELLENCE STAR STAR FT RODAMIENTO A BOLAS BALL BEARING ROULEMENT À BILLES</p>		0 981 93		1 juego 1 set 1 jeu



Componentes

Components | Composants

ACCESORIOS ACCESSORIES ACCESSOIRES	Acabado	Cód.		
 <p>93 mm</p> <p>Tapeta Pelmet cover Cache</p>	<p>S</p> <p>BL</p>	<p>00 64 23 00 64 33 00 64 53</p> <p>00 64 25 00 64 45 00 64 55</p>	<p>2 m 3 m 5 m</p> <p>2 m 3 m 5 m</p>	<p>2 perfiles 2 profiles 2 profils</p>
 <p>Embellecedor final para perfil superior Standard Final trim for Standard top track Capuchon final pour rail Standard</p>  <p>STANDARD</p>	<p>PPS</p>	<p>00 80 57</p>		<p>25 piezas 25 pieces 25 pièces</p>
 <p>Juego de tapas laterales Standard. Montaje a techo. Tapeta + perfil superior Standard + tapeta Standard lateral cap set. Ceiling mounting. Pelmet cover + Standard top track + Pelmet cover Jeu de capuchons latéraux Standard. Fixation à plafond. Cache + Rail supérieur Standard. + Cache</p>	<p>S</p> <p>BL</p>	<p>00 82 70</p> <p>00 82 71</p>		<p>1 juego 1 set 1 jeu</p>
 <p>Juego de tapas laterales Standard. Montaje a pared. Escuadra + Perfil superior Standard + Tapeta Standard lateral cap set. Wall mounting. Bracket + Standard top track + Pelmet cover Jeu de capuchons latéraux Standard. Fixation à mur. Équerre + Rail supérieur Standard + Cache</p>	<p>S</p> <p>BL</p>	<p>00 82 72</p> <p>00 82 73</p>		<p>1 juego 1 set 1 jeu</p>
 <p>Juego de tapas laterales Excellence. Montaje a techo. Tapeta + perfil superior Excellence + tapeta Excellence lateral cap set. Ceiling mounting. Pelmet cover + Excellence top track + Pelmet cover Jeu de capuchons latéraux Excellence. Fixation à plafond. Cache + Rail supérieur Excellence + Cache</p>	<p>S</p> <p>BL</p>	<p>00 82 74</p> <p>00 82 75</p>		<p>1 juego 1 set 1 jeu</p>
 <p>Juego de tapas laterales Excellence. Montaje a pared. Perfil superior separador + Perfil superior Excellence + Tapeta Excellence lateral cap set. Wall mounting Separator top track + Excellence top track + Pelmet cover Jeu de capuchons latéraux Excellence. Fixation à mur. Rail supérieur séparateur + Rail supérieur Excellence + Cache</p>	<p>S</p> <p>BL</p>	<p>00 82 76</p> <p>00 82 77</p>		<p>1 juego 1 set 1 jeu</p>

S Aluminio anodizado plata mate
Satin anodized aluminium
Aluminium anodisé argent









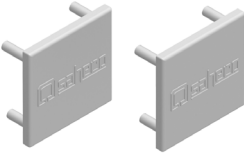

BL Aluminio lacado negro mate
Matt black lacquered aluminium
Aluminium anodisé laqué noir mat

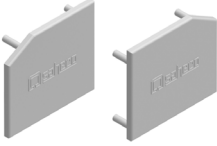
PPS Plástico pintado plata
Plastic painted silver
PVC finition peinture argent



Componentes

Components | Composants

ACCESORIOS ACCESSORIES ACCESSOIRES		Acabado	Cód.		
	<p>Juego de tapas laterales Star. Montaje a techo/pared. Star lateral cap set. Ceiling/wall mounting Jeu de capuchons latéraux Star. Fixation à plafond/mur</p>  <p>33x23mm</p>	<p>PPS</p> <p>PPB</p>	<p>00 52 10</p> <p>00 52 11</p>		<p>1 juego</p> <p>1 set</p> <p>1 jeu</p>
	<p>Juego de tapas laterales Star. Montaje a pared. Perfil superior separador Excellence / Star + Perfil superior Star Star lateral cap set. Wall mounting. Excellence/Star separator top track + Star top track Jeu de capuchons latéraux Star. Fixation à mur. Rail supérieur séparateur Excellence/Star + Rail supérieur Star</p>  <p>49x43mm</p>	<p>PPS</p> <p>PPB</p>	<p>00 52 15</p> <p>00 52 16</p>		<p>1 juego</p> <p>1 set</p> <p>1 jeu</p>
	<p>Roldana SF-P50 con tornillo SF-P50 Roller with screw Galet SF-P50 avec vis</p>		00 52 01		<p>25 piezas</p> <p>25 pièces</p> <p>25 pièces</p>
	<p>Roldana SF-A60 con tornillo (rodamiento a fricción) (pletina 00 60 53 / 00 60 60) SF-A60 Roller with screw (friction bearing) (plate 00 40 59 / 00 60 53 / 00 60 60) Galet SF-A60 avec vis porteuse (roulement à friction) (platine 00 40 59 / 00 60 53 / 00 60 60)</p>		00 60 52		<p>25 piezas</p> <p>25 pièces</p> <p>25 pièces</p>
	<p>Roldana SF-P70 con tornillo SF-P70 Roller with screw Galet SF-P70 avec vis</p>  <p>RODAMIENTO A BOLAS BALL BEARING ROULEMENT À BILLES</p>		00 72 04		<p>25 piezas</p> <p>25 pièces</p> <p>25 pièces</p>
	<p>Roldana SF-A90 con tornillo (Pletina 00 60 53 / 00 60 60) SF-A90 Roller with screw (Plate 00 60 53 / 00 60 60) Galet SF-A90 avec vis (Platine 00 60 53 / 00 60 60)</p>  <p>RODAMIENTO A BOLAS BALL BEARING ROULEMENT À BILLES</p>		00 80 52		<p>25 piezas</p> <p>25 pièces</p> <p>25 pièces</p>

PPS Plástico pintado plata
Plastic painted silver
PVC finition peinture argent

PPB Plástico pintado negro
Black painted plastic
PVC peinture noir

Componentes

Components | Composants

ACCESORIOS ACCESSORIES ACCESSOIRES		Acabado	Cód.	اسستاس	📦
 <p>Pletina fijación lateral para paneles de poco grueso Lateral fixing plate for panels of small thickness Panneaux latéraux de fixation pletina peu épaisse</p>			00 40 59		25 piezas 25 pièces 25 pièces
 <p>Pletina regulación sobrepuesta Face fixed adjustable mounting plate Plaque de réglage superposée</p>			00 60 53		25 piezas 25 pièces 25 pièces
 <p>Pletina regulación encastrada Recessed adjustable mounting plate Plaque de réglage à encastrer</p>			00 60 60		25 piezas 25 pièces 25 pièces
 <p>26,75mm</p> <p>Soporte pared escuadra Wall fixing bracket Support équerre pour fixation à mur</p>    <p>STANDARD EXCELLENCE STAR</p>			00 60 54 ¹		25 piezas 25 pièces 25 pièces
 <p>32,5mm</p> <p>Soporte pared escuadra con regulación Adjustable wall fixing bracket Support équerre pour fixation à mur réglable</p>    <p>STANDARD EXCELLENCE STAR</p>			00 60 59 ¹		25 piezas 25 pièces 25 pièces

¹Para las familias que incorporen soporte pared con perfilera de 2 m, 3 m o 5 m, aplicar uno por cada taladro | ¹For sets that incorporate a wall support with 2m, 3m, 5m or 6m profiling, apply one for each drill hole | ¹Pour les familles intégrant un support mural avec huisserie de 2m, 3m, 5m ou 6m, appliquer un support pour chaque trou percé.

2 m - 10 soportes pared | supports wall | supports muraux **3 m** - 15 soportes pared | supports wall | supports muraux **5 m** - 25 soportes pared | supports wall | supports muraux



Componentes

Components | Composants

ACCESORIOS ACCESSORIES ACCESSOIRES		Acabado	Cód.	اساسيات	
	Soporte tapeta universal Universal pelmet cover support Support cache universel		00 60 56		10 piezas 10 pieces 10 pièces
	Topo freno SF-A60 / SF-A90 SF-A60 / SF-A90 Brake stopper Butée arrêt SF-A60 / SF-A90		00 60 55		25 piezas 25 pieces 25 pièces
	Freno retenedor SF-A60 / SF-A90 SF-A60 / SF-A90 Retaining stopper Frein de retenue SF-A60 / SF-A90		00 60 57		25 piezas 25 pieces 25 pièces
	Freno retenedor SF-P70 SF-P70 Retaining stopper Frein de retenue SF-P70		00 72 19		25 piezas 25 pieces 25 pièces
	Guiador inferior plástico Plastic bottom guide Guide inférieur plastique		00 35 54		25 piezas 25 pieces 25 pièces

Essential Timber

SF-P50 | SF-A60 | SF-P70 | SF-A90 |

SF-RA P50 | SF-RA A60 | SF-RA P70 | SF-RA A90



Polígono Industrial de Foradada / 08580
St. Quirze de Besora / Barcelona / Spain
T +34 93 852 92 23
F +34 93 852 91 59
saheco@saheco.com

Export contact details
T +34 93 852 96 15
F +34 93 855 13 42
export@saheco.com
saheco.com