

L'ARTE DI ARREDARE



FORMAE®

**L'arte di arredare!**

Il design innovativo della collezione "FORMAE" personalizza e valorizza il mobile d'arredamento. La praticità della funzione nell'utilizzo e gli elevati standards di eccellenza qualitativa sono le prerogative dei prodotti del progetto "FORMAE".

The art of decorating!

The innovative design of the "FORMAE" collection adds personality and character to any piece of furniture. Usability and high standards of excellence in manufacturing are the main features of this product line.

MM maniglie per mobile
furniture handles



F101
04



F102
05



F103
06



F104
07



F105
10



F107
11



F108
12



F114
13



F118
16



F120 DX
F120 SX
17



F124
18



F125
19



F126
22



F127
23



F128
24



F129
25



F130
28



F131
29



F133
30



F134
31



F135
34



F136
35



F137
36



F138
37



F109
40



F112
41



F501 DX
F501 SX
42



F503
43



F511
46



F512
47



F514
58



F515
49



F517
52



F519
53



F521
54



F522
55



F524
58



F525
59



F526
60



F527
61



F528
64



F529
65



F530
66



F531
67



F532
70



F533
71



F534
72



F535
73



F536
76



F537
77



F538
78



F539
79



F101

Bartoli Design

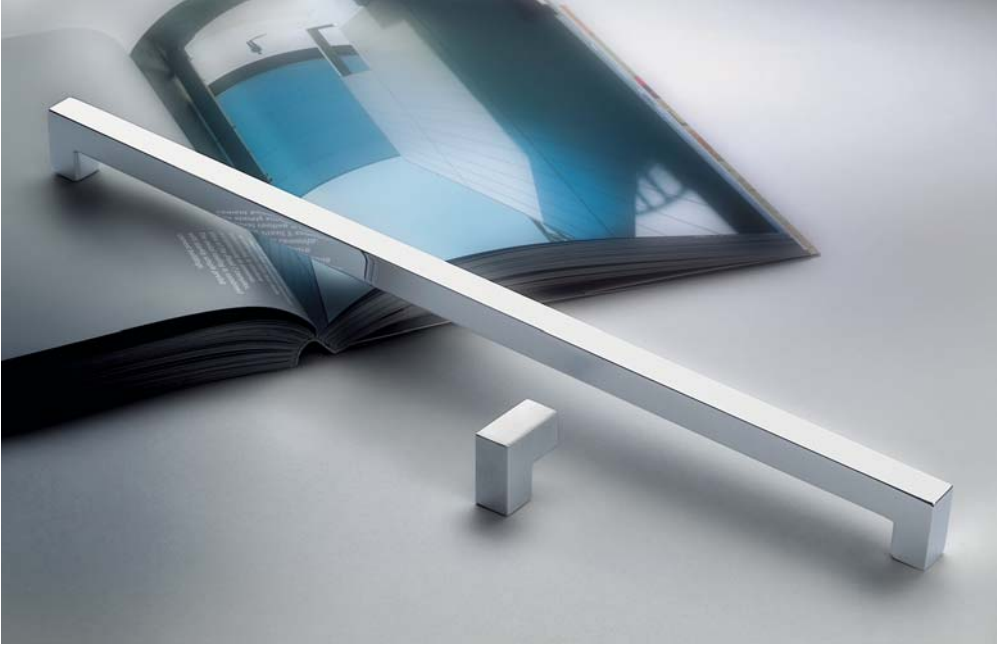

Materiale: Cromall®
Material: Cromall®

Finiture: Cromo
Finishes: Chrome
 Cromosat
 Satin chrome

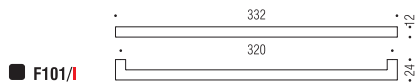
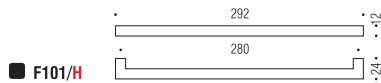
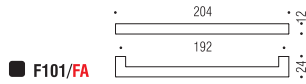
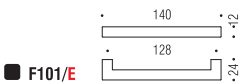
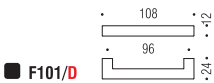
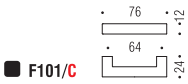

F102

Bartoli Design



Materiale: Cromall®
Material: Cromall®

Finiture: Cromo
Finishes: Chrome

Cromosat
Satin chrome

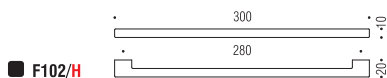
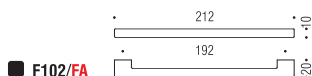
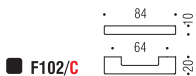



Materiale: Cromall®
Material: Cromall®

- Finiture: Cromo
Finishes: Chrome
- Cromosat
Satin chrome

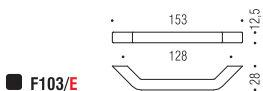
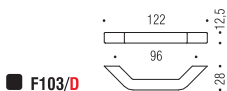
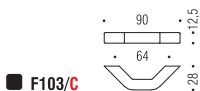

F104

Bartoli Design



Materiale: Cromall®
Material: Cromall®

- Finiture: Cromo
Finishes: Chrome
- Cromosat
Satin chrome

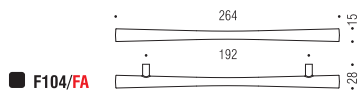
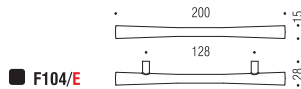
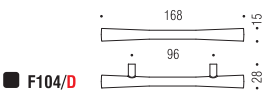
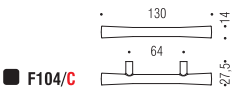
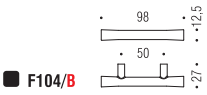





A nuovo sistema disegnato da Rifra, il frutto di una ridisegnazione, ridisegna il bagno

Il progettista al mondo del bagno...
...progetta si sensibilizzassero...
...alla ricerca e all'elaborazione...
...di un nuovo sistema...
...disegnato da Rifra...
...il frutto di una ridisegnazione...
...ridisegna il bagno

ini e disegni del sistema...
...sketches per Rifra...
...Associati for the Modus...
...Associati for the Modus



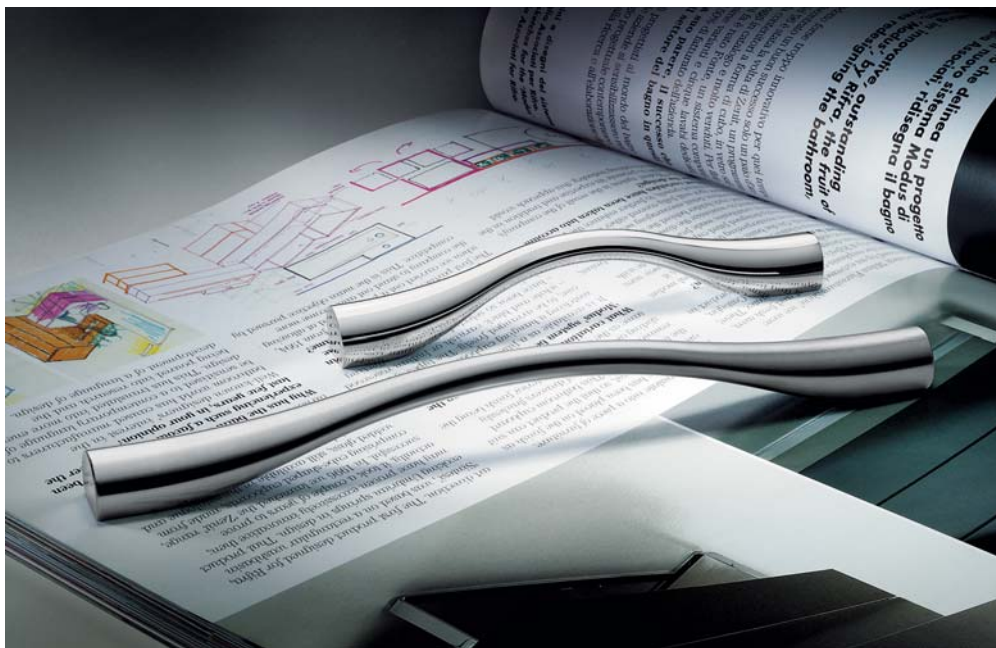

Materiale: Cromall®
Material: Cromall®

Finiture: Cromo
Finishes: Chrome

Cromosat
Satin chrome

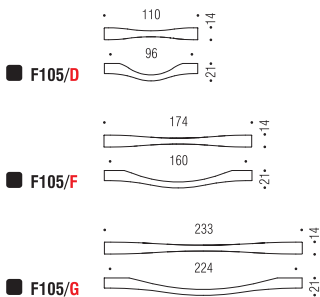

F107

Bartoli Design



Materiale: Cromall®
Material: Cromall®

- Finiture: Cromo
Finishes: Chrome
- Cromosat
 Satin chrome

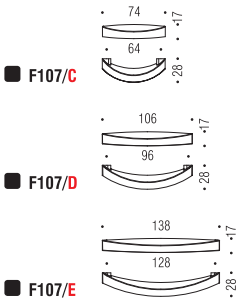



Materiale: Cromall®
Material: Cromall®

- Finiture: Cromo
Finishes: Chrome
- Cromosat
Satin chrome

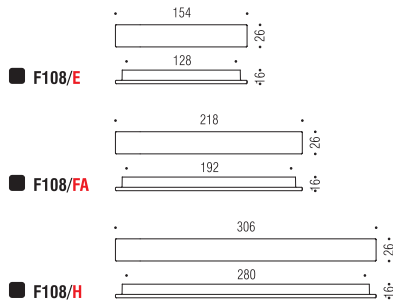
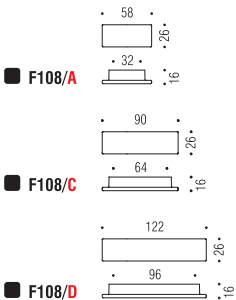

F114

Bartoli Design



Materiale: Cromall®
Material: Cromall®

- Finitura: Cromo
Finishes: Chrome
- Cromosat
Satin chrome

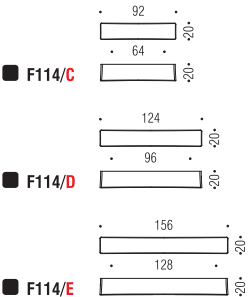







Materiale: Cromall®
Material: Cromall®

- Finiture: Cromo
Finishes: Chrome
- Cromosat
Satin chrome

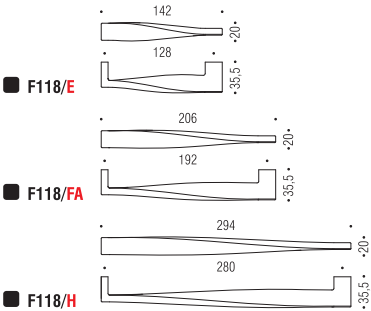



Materiale: Cromall®
Material: Cromall®

- Finiture: Cromo
Finishes: Chrome
- Cromosat
Satin chrome

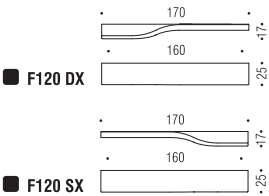



Materiale: Cromall®
Material: Cromall®

- Finiture: Cromo
Finishes: Chrome
- Cromosat
Satin chrome

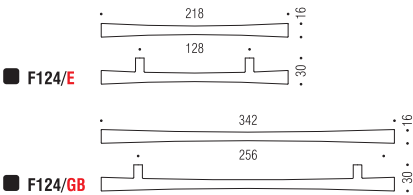

F125

Pio e Tito Toso lab

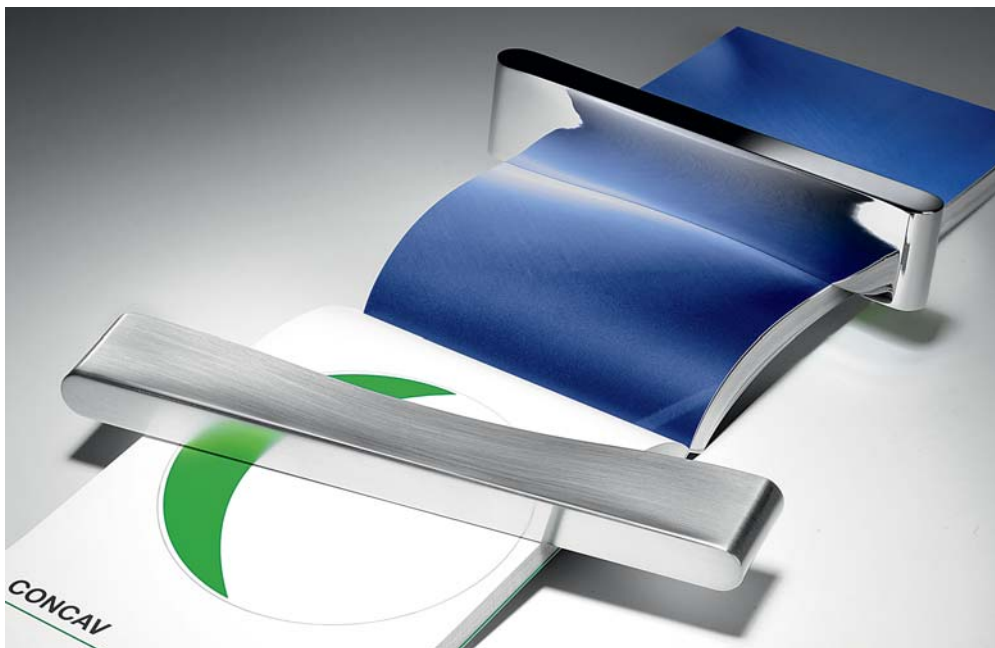

Materiale: Cromall®
 Material: Cromall®

- Finiture: Cromo
 Finishes: Chrome
- Cromosat
 Satin chrome

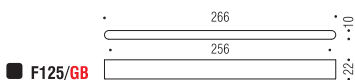
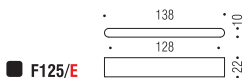
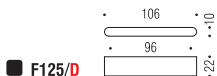







Materiale: Cromall®/Alluminio
 Material: Cromall®/Aluminium

Finiture:  Cromo/Cromo
 Chrome/Chrome
 Finishes:  Cromo/Cromosat
 Chrome/Satin chrome

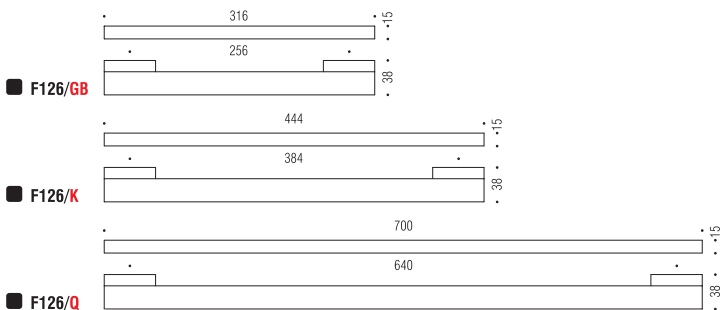

F127

Bartoli Design

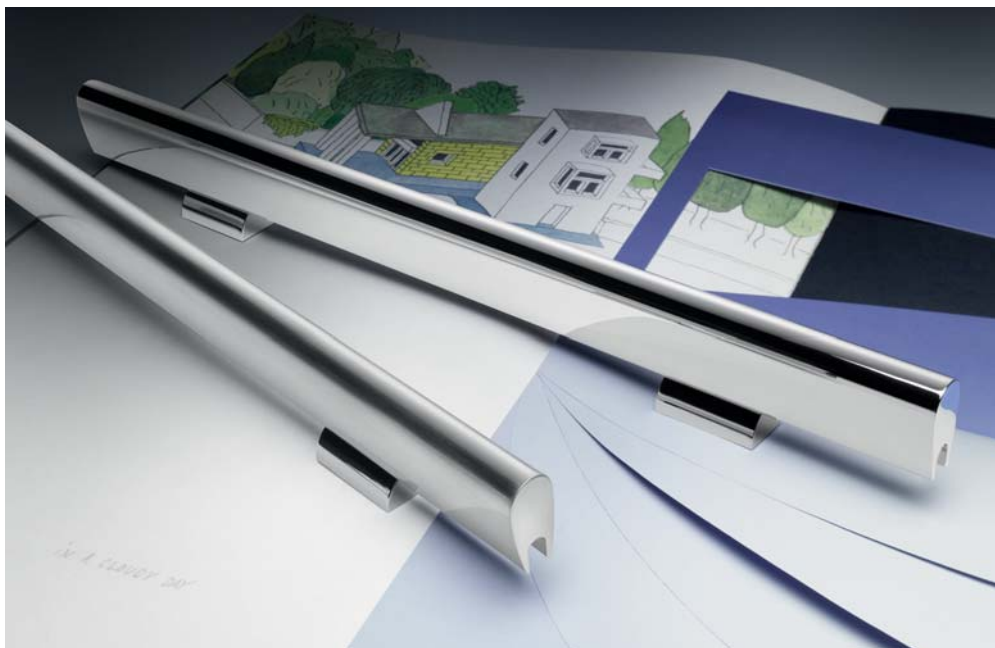

Materiale: Cromal®/Alluminio
 Material: Cromal®/Aluminium

- Finiture: Cromo/Cromo
 Finishes: Chrome/Chrome
- Cromo/Cromosat
 Chrome/Satin chrome

Interesse modificabile in fase di installazione nelle misure indicate
 End user may modify centre as per the indicated sizes

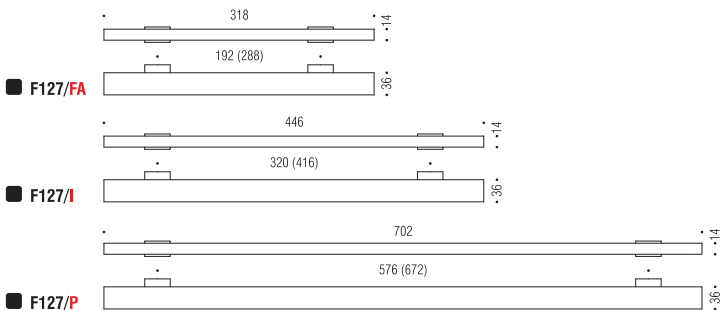



Materiale: Cromall®/Alluminio
 Material: Cromall®/Aluminium

Finiture:  Cromo/Cromo
 Finishes:  Chrome/Chrome
 Cromo/Cromosat
 Chrome/Satin chrome

 Interesse modificabile in fase di installazione nelle misure indicate
 End user may modify centre as per the indicated sizes

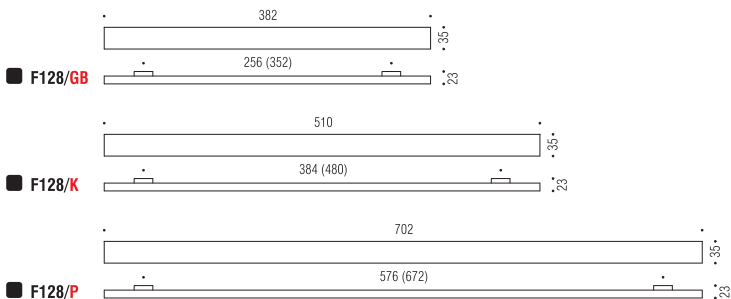

F129

Pio e Tito Toso lab



Materiale: Cromall®
Material: Cromall®

- Finiture: Cromo
Finishes: Chrome
- Cromosat
Satin chrome

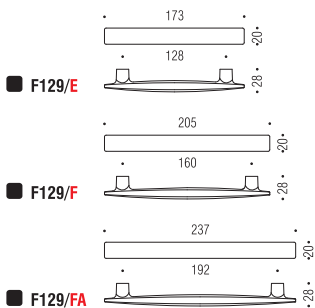







Materiale: Cromall®
Material: Cromall®

Finiture: Cromo
Finishes: Chrome

Cromosat
Satin chrome

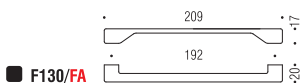
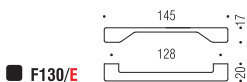
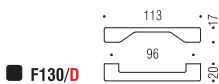

F131

Pio e Tito Toso lab



Materiale: Cromall®
Material: Cromall®

- Finiture: Cromo
Finishes: Chrome
- Cromosat
Satin chrome

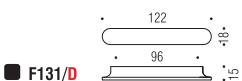
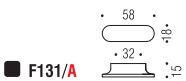



F133

Messineo e Settimelli



Materiale: Cromall®
Material: Cromall®

Finiture: Cromo
Finishes: Chrome

Cromosat
Satin chrome

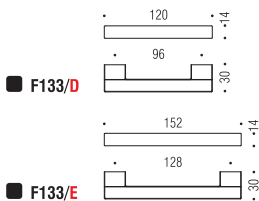

F134

Messineo e Settimelli



Materiale: Cromall®
Material: Cromall®

- Finiture: Cromo
Finishes: Chrome
- Cromosat
Satin chrome

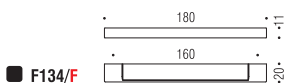
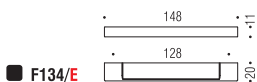
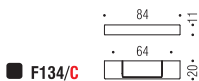







Materiale: Cromall®
Material: Cromall®

- Finiture: Cromo
Finishes: Chrome
- Cromosat
Satin chrome

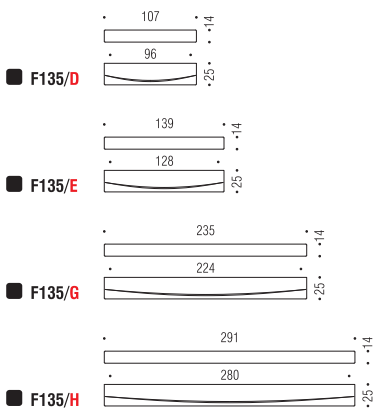



Materiale: Cromall®
Material: Cromall®

Finiture: Cromo
Finishes: Chrome

Cromosat
Satin chrome

 Interesse modificabile in fase di installazione nelle misure indicate
End user may modify centre as per the indicated sizes

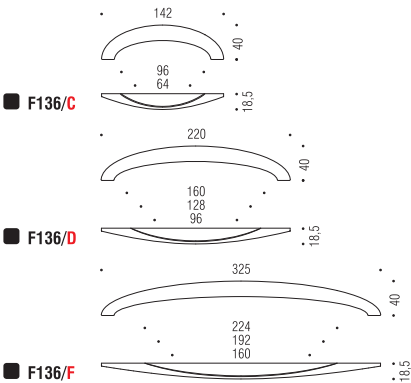



Materiale: Cromall®
 Material: Cromall®

- Finiture: Cromo
 Finishes: Chrome
- Cromosat
 Satin chrome

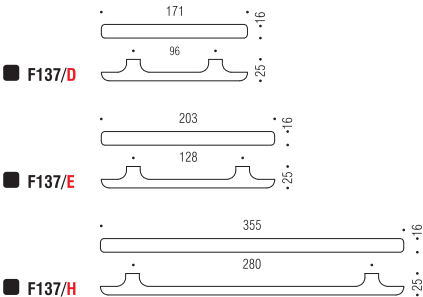



Materiale: Cromall®
Material: Cromall®

Finiture: Cromo
Finishes: Chrome

Cromosat
Satin chrome

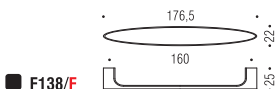
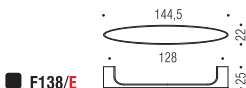
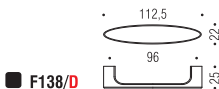
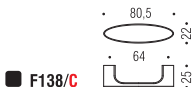

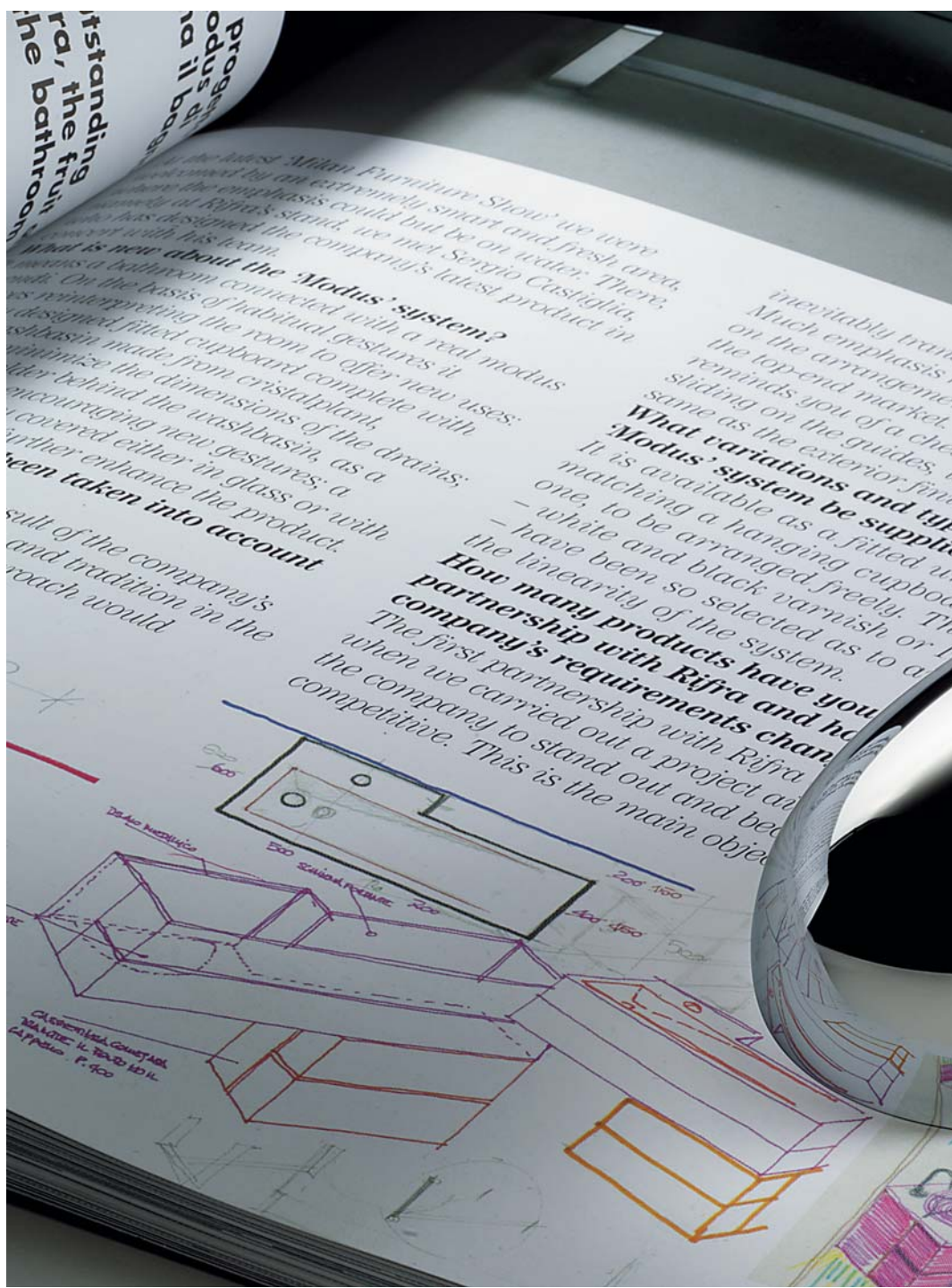

standing
ra, the fruit
the bathroom

Prodotto
oduso di
na il bagno

...the latest Milan Furniture Show' we were
...by an extremely smart and fresh crew.
...the emphasis could be on water. There,
...of Riforma's stand, we met Sergio Castiglia,
...has designed the company's latest product in
...with his team.

What is new about the 'Modus' system?

...a bathroom connected with a real modus
...On the basis of habitual gestures it
...reinterpreting the room to offer new uses:
...designed fitted cupboard complete with
...basin made from crystalplant, as a
...minimize the dimensions of the drains;
...behind the washbasin, as a
...encouraging new gestures, as a
...covered either in glass or with
...further enhance the product.

What has been taken into account

...of the company's
...and tradition in the
...reach would

inevitably travel
Much emphasis is
on the arrangement
the top-end market.
reminds you of a chef
sliding on the guides, in
same as the exterior, firm

What variations and typologies of 'Modus' system are supplied?

It is available as a fitted unit
matching a hanging cupboard
one, to be arranged freely. The
- white and black varnish or
- have been so selected as to a
the linearity of the system.

How many products have you developed in partnership with Riforma and how do you think the company's requirements change over time?

The first partnership with Riforma
when we carried out a project at
the company to stand out and be
competitive. This is the main objective

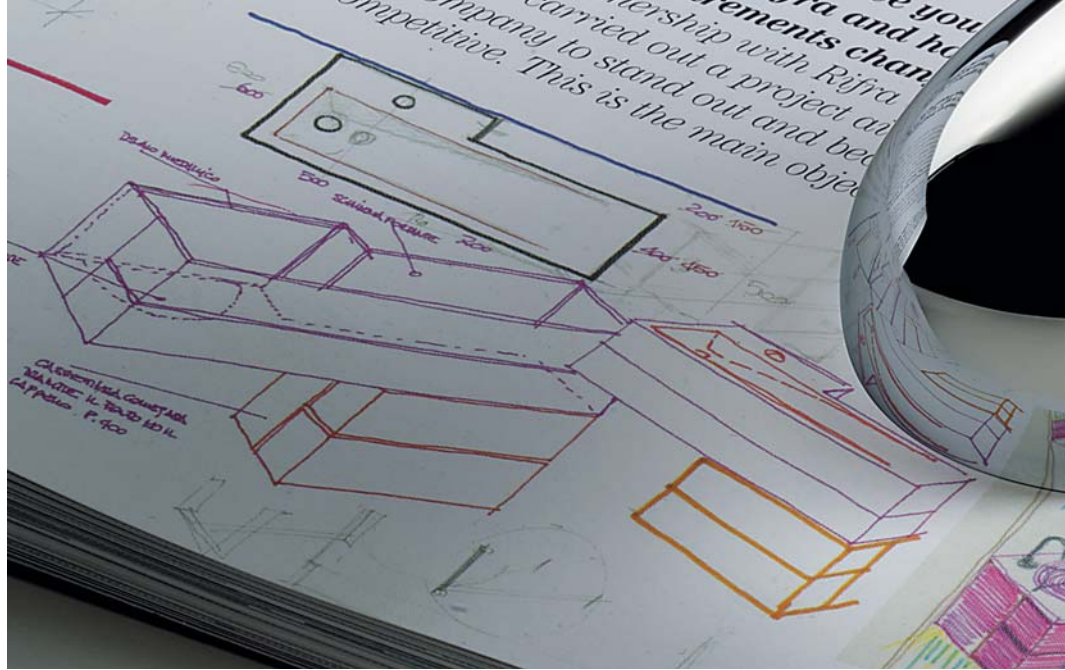

...plate into a piece of furniture.
...has been placed on the finish as
...nt, so that the product can suit
... This bathroom cupboard
...est of drawers flawlessly
... the interior finish bein
...ish.

...pes of finish ...ied with?

...mit 120
...ard c
...e
...t

...art direction. The first product
... 'Sintesi'; was based on a rectang
... evoking Umbrian springs in des
... may have proven excessively inn
... it took a couple of years to
... 1996 we launched the
... shaped cupboards,
... available in the cate
... ally, four years a
... system, 'Fonte'
... five dedicated
... es up 50% of Re

Why has the bathroom furniture industry experiencing such a favorable trend over the last few years, in your opinion?

Well-known designers' interest in the
bathroom world has caused manufacturers
to be sensitised to a contemporary language of
design. This has translated into more energy
being poured into research and the
development of a language of design.





Materiale: Cromall®
Material: Cromall®

- Finiture: Cromo
Finishes: Chrome
- Cromosat
Satin chrome

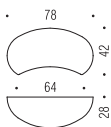

F112

Bartoli Design

PM



Materiale: Cromall®
Material: Cromall®

Finiture: Cromosat/Cromo
Finishes: Satin chrome/Chrome

■ F112

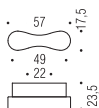

F501 DX . F501 SX

Bartoli Design



Materiale: Cromall®
Material: Cromall®

Finiture:  Cromosat/Cromo
Finishes:  Satin chrome/Chrome

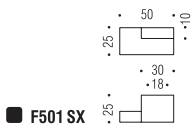
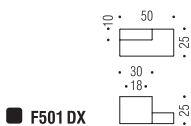

F503

Bartoli Design



Materiale: Cromall®
Material: Cromall®

- Finiture: Cromo
Finishes: Chrome
 Cromosat
 Satin chrome

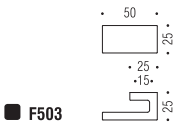







Materiale: Cromall®/Ottone
Material: Cromall®/Brass

Finiture: Cromo
Finishes: Chrome
 Cromosat
 Satin chrome

F512

Bartoli Design

PM



Materiale: Cromall®
Material: Cromall®

Finiture: Cromo
Finishes: Chrome
 Cromosat
 Satin chrome

■ F512





Materiale: Cromall®
Material: Cromall®

Finiture: Cromo
Finishes: Chrome

Cromosat
Satin chrome



F515

Bartoli Design

PM

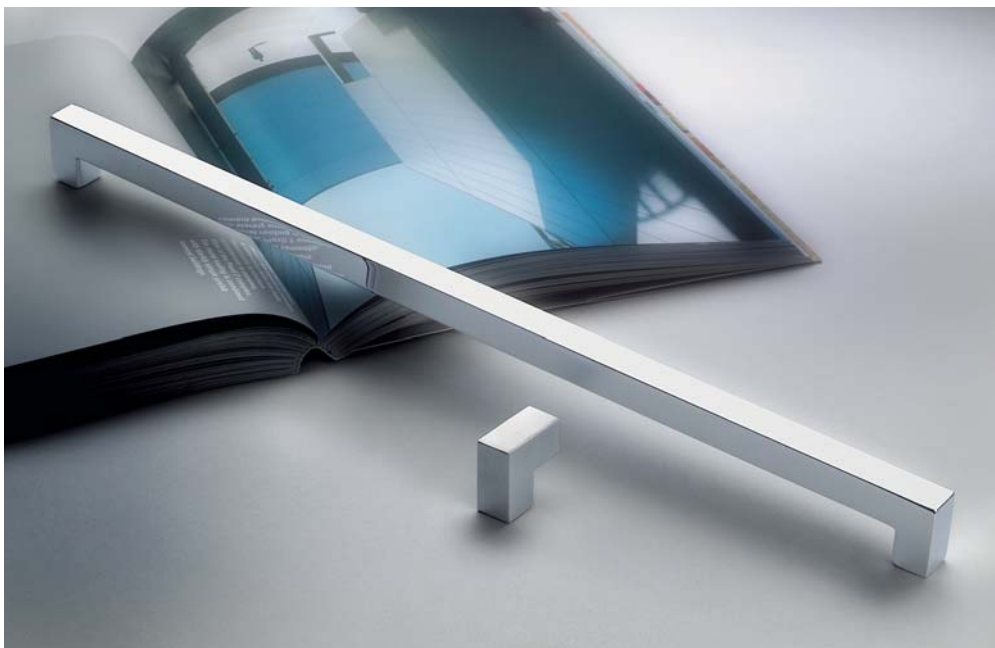

Materiale: Cromall®
Material: Cromall®

Finiture: Cromo
Finishes: Chrome

Cromosat
Satin chrome

■ F515

12
24
24



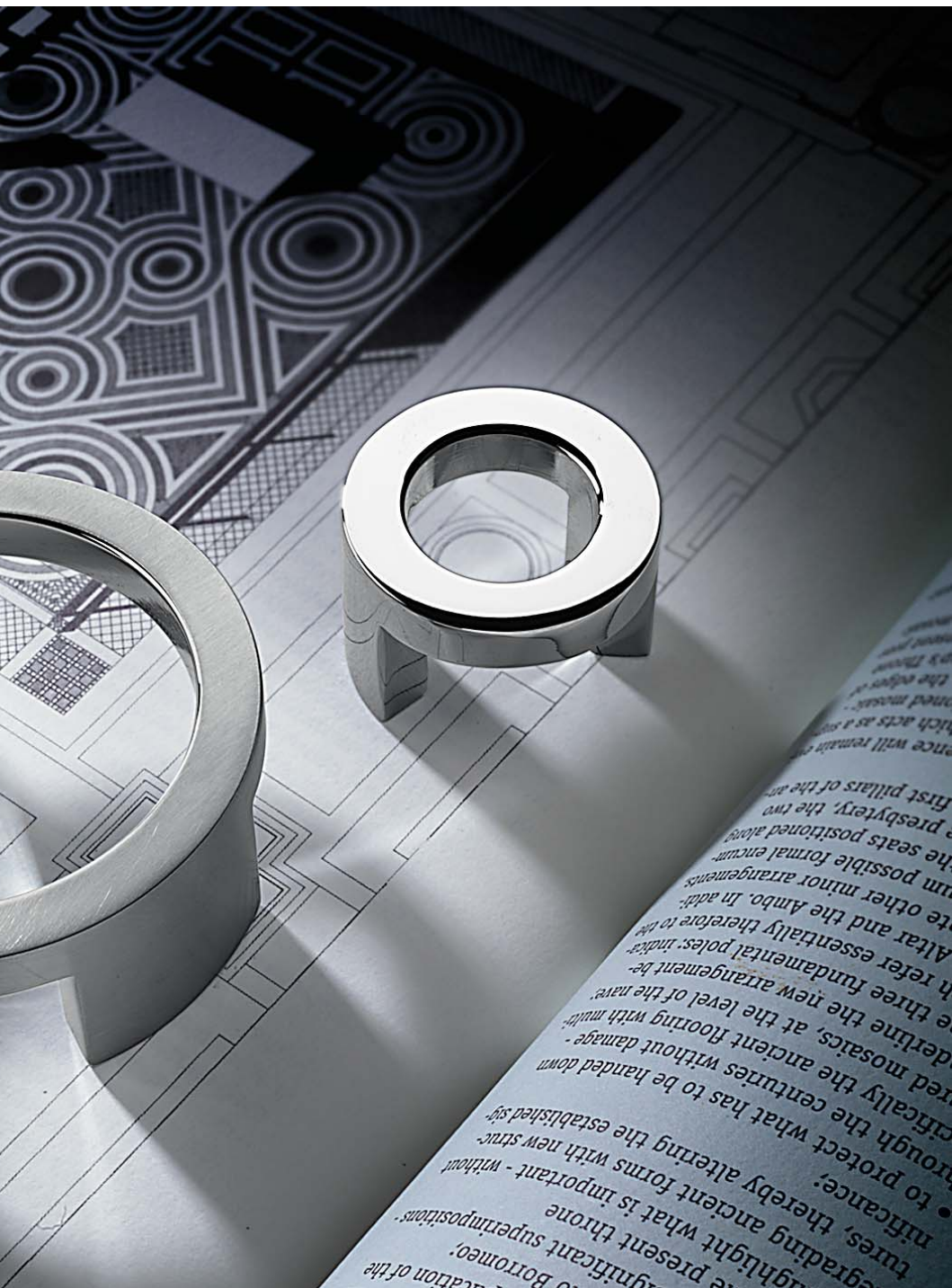

...to protect what has to be handed down
through the centuries without damage -
to protect what is important - without
degrading ancient forms with new struc-
tures, thereby altering the established sy-
nificance;
to protect what is important - without
degrading ancient forms with new struc-
tures, thereby altering the established sy-
nificance;
to protect what is important - without
degrading ancient forms with new struc-
tures, thereby altering the established sy-
nificance;
to protect what is important - without
degrading ancient forms with new struc-
tures, thereby altering the established sy-
nificance;

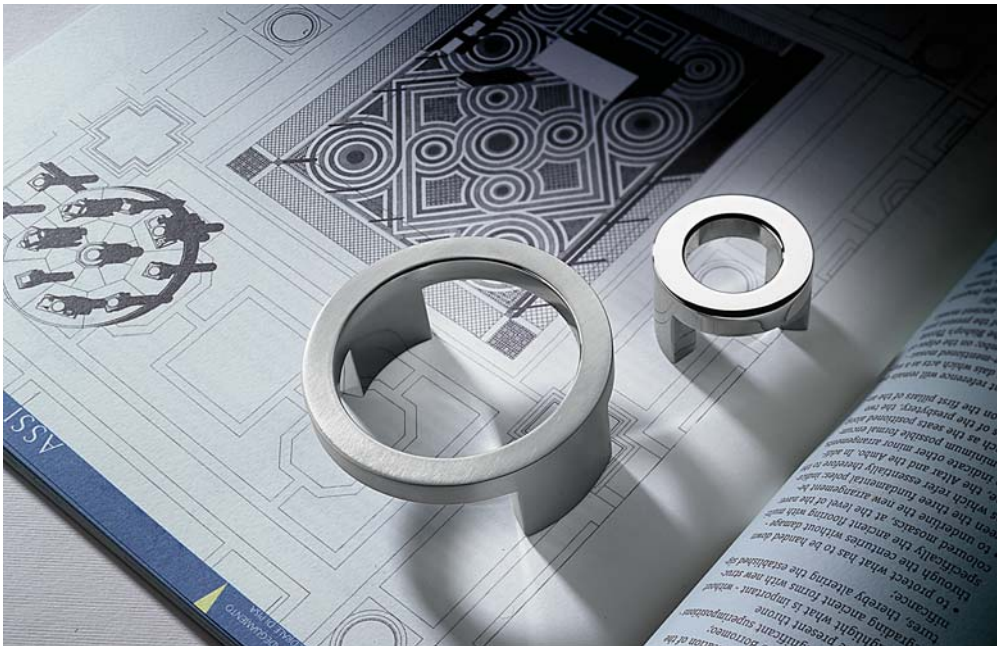

Materiale: Cromall®
Material: Cromall®

- Finiture: Cromo
Finishes: Chrome
- Cromosat
Satin chrome

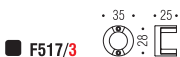
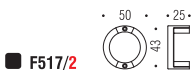
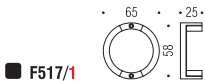



Materiale: Cromall®
Material: Cromall®

- Finiture: Cromo
Finishes: Chrome
- Cromosat
Satin chrome





Materiale: Cromall®
Material: Cromall®

Finiture: Cromo
Finishes: Chrome

Cromosat
Satin chrome





Materiale: Cromall®
Material: Cromall®

- Finiture: Cromo
Finishes: Chrome
- Cromosat
Satin chrome





SIAN IN





Materiale: Cromall®
Material: Cromall®

Finiture: Cromo/Cromosat
Finishes: Chrome/Satin chrome

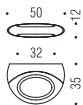

F525

Pio e Tito Toso lab

PM



Materiale: Cromall®
Material: Cromall®

Finiture: Cromo
Finishes: Chrome

Cromosat
Satin chrome

■ F525





Materiale: Cromall®
Material: Cromall®

Finiture: Cromo
Finishes: Chrome

Cromosat
Satin chrome

F527

Messineo e Settimelli

PM



Materiale: Cromall®
Material: Cromall®

Finiture: Cromo
Finishes: Chrome

Cromosat
Satin chrome

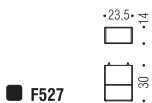



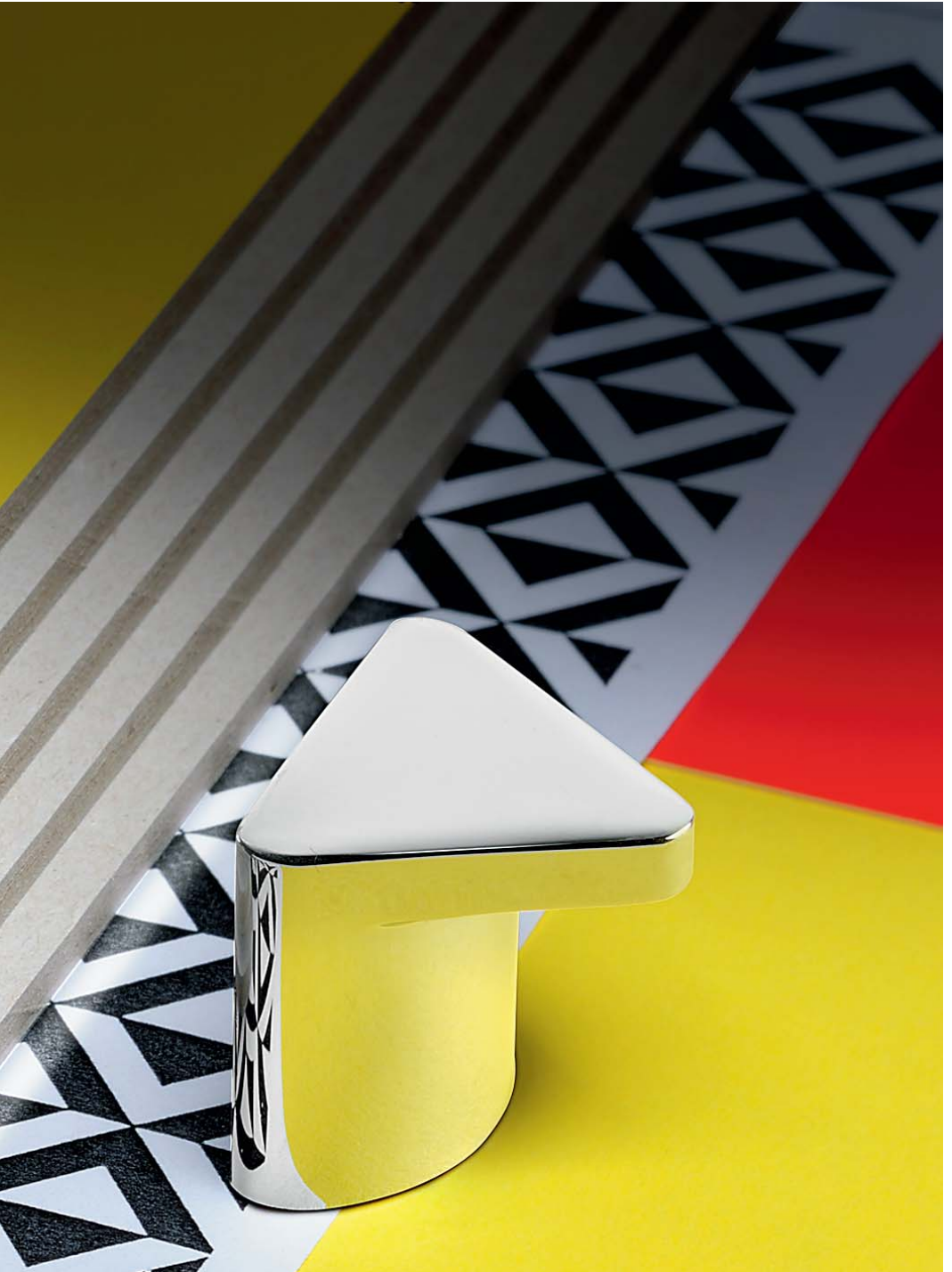



Materiale: Cromall®
 Material: Cromall®

Finiture: Cromo
 Finishes: Chrome

Cromosat
 Satin chrome



F529

Pio e Tito Toso lab



Materiale: Cromall®
Material: Cromall®

- Finiture: Cromo
Finishes: Chrome
- Cromosat
Satin chrome

■ F529





Materiale: Cromall®
Material: Cromall®

Finiture: Cromo
Finishes: Chrome

Cromosat
Satin chrome

F531

Francesco Polare

PM



Materiale: Cromall®
Material: Cromall®

Finiture: Cromo
Finishes: Chrome

Cromosat
Satin chrome

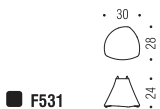







Materiale: Cromall®
Material: Cromall®

Finiture: Cromo
Finishes: Chrome

Cromosat
Satin chrome



F533

Ciani Billi Design

PM



Materiale: Cromall®
Material: Cromall®

Finiture: Cromo
Finishes: Chrome

Cromosat
Satin chrome

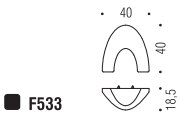



Materiale: Cromall®
Material: Cromall®

Finiture: Cromo
Finishes: Chrome

Cromosat
Satin chrome

F535

Nicola Novelletto

PM



Materiale: Cromall®
Material: Cromall®

Finiture: Cromo
Finishes: Chrome

Cromosat
Satin chrome

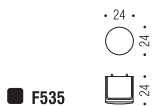





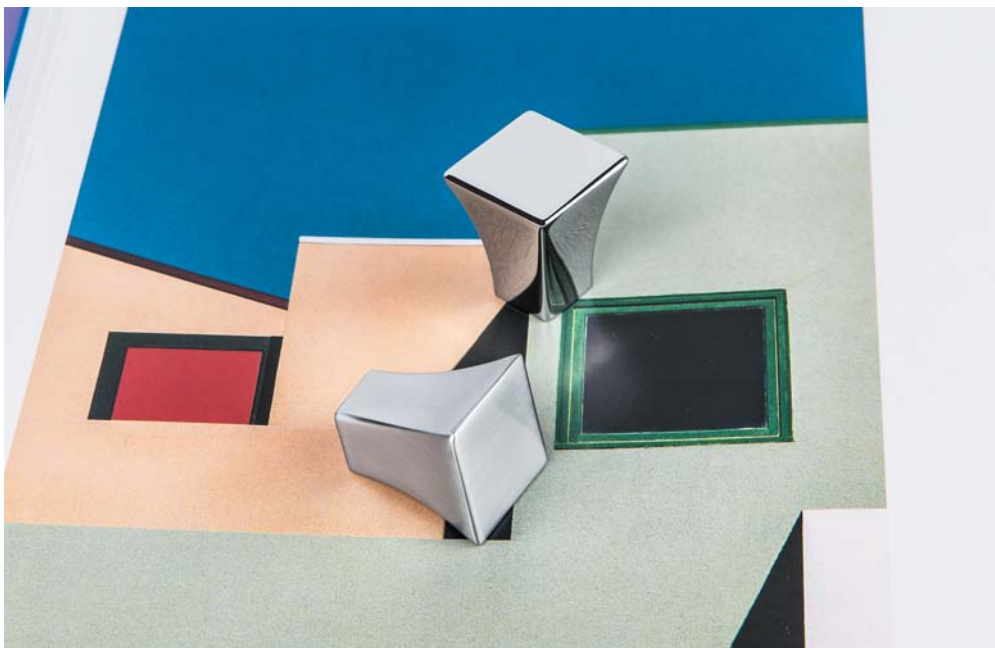

Materiale: Cromall®
Material: Cromall®

Finiture: Cromo
Finishes: Chrome

Cromosat
Satin chrome

F537

Stefano Pasotti

PM



Materiale: Cromall®
Material: Cromall®

Finiture: Cromo
Finishes: Chrome

Cromosat
Satin chrome

■ F537

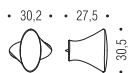

PM

F538

Stefano Pasotti



Materiale: Cromall®
Material: Cromall®

Finiture: Cromo
Finishes: Chrome

Cromosat
Satin chrome

■ F538

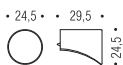

F539

Stefano Pasotti

PM



Materiale: Cromall®
Material: Cromall®

Finiture: Cromo
Finishes: Chrome

Cromosat
Satin chrome

■ F539

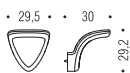

Concept and graphic design

Colombo Design

Printed in Italy

01/18

Colombo Design si riserva di apportare ai propri prodotti ogni modifica estetica e tecnica che a suo insindacabile giudizio ritenga necessaria.

Il presente catalogo è tutelato dalla legge sui diritti di autore di esso è quindi proibita ogni riproduzione, totale o anche parziale.

Il listino prezzi può avere frequenze di aggiornamento superiori al catalogo generale, costituisce quindi lo strumento di consultazione più aggiornato.

I colori dei materiali e delle finiture hanno valore indicativo in quanto soggetti alle tolleranze dei processi di stampa.

Le misure indicate sono espresse, se non specificato diversamente, in millimetri.

Colombo Design reserves the right to modify parts of its collection range whenever necessary without previous notice.

This catalogue is protected by the Italian copyright laws. No part of this catalogue may be reproduced in any form or by any means.

The price-list has a printing frequency higher than the general catalogue, therefore it is the most up-dated consulting tool.

The colours of materials and finishes are not binding as they depend on printing colour tolerances.

All measures mentioned herein are stated in millimeters, if not differently specified.



FORMAE[®]

Trademark of:



COLOMBO[®]
DESIGN

COLOMBO DESIGN S.p.A.
Via Baccanello, 22
24030 Terno d'Isola (BG) Italia
☎ 035.49.49.001
Fax 035.90.54.44

Export Office
☎ (+39) 035.90.54.75
Fax (+39) 035.49.40.257

Internet: <http://www.colombodesign.it>
e-mail: info@colombodesign.it

follow us on

