



Living

Messing ongelakt - Brass unlacquered - Messing unlackiert - Laiton non laquée
Messing getrommeld - Brass vibrated - Messing Natur - Laiton vieilli
Messing gelakt - Brass lacquered - Messing lackiert - Laiton verni
Oud grijs - Old grey - Alt grau - Vieux gris
Messing gebruineerd - Brass antique - Messing brüniert - Laiton bronzé
Messing titanium - Brass titanium - Messing Titanium - Laiton poli titane

Landelijk & Klassiek
Rustic & Classic
Ländlich & Klassik
Rustique & Classique



Living

Landelijk & Klassiek
Rustic & Classic
Ländlich & Klassik
Rustique & Classique

INTERSTEEL Living

Intersteel beheerst de kunst van het koppelen van moderne technologieën aan elegant design. Voor elke woonstijl bestaat wel een productlijn die een extra element toevoegt aan het interieurdesign. De producten uit de Living collectie passen bij veel interieurstijlen en -smaken: modern & strak, landelijk & klassiek of vintage & retro. De Living collectie bestaat uit producten met een hoge kwaliteit in diverse kleuren zoals roestvast staal, messing, zwart, nikkel en meer. Geef deuren en ramen een eigen finishing touch met de producten uit de Living collectie.



Intersteel commands the art of linking modern technology to elegant design. For each interior style, there is a line of products that add an extra touch to the interior design. The products of the Living collection fit in with many interior styles and tastes: modern and clean-cut, rustic and classic or vintage and retro. The Living collection consists of high-quality products in various colours such as stainless steel, brass, black, nickel, and many more. Use the products of the Living collection to give your windows and doors a personal finishing touch.

Intersteel beherrscht die Kunst der Verbindung von modernen Technologien und elegantem Design. Für jeden Wohnstil gibt es eine Produktlinie, die dem Einrichtungsdesign ein besonderes Element hinzufügt. Die Produkte aus der Living-Kollektion passen zu vielen Einrichtungsstilen und -geschmäckern: modern & geradlinig, ländlich & klassisch oder Vintage & Retro. Die Living-Kollektion besteht aus hochwertigen Produkten in unterschiedlichen Farben wie Edelstahl, Messing, Schwarz-Nickel und mehr. Verleihen Sie Türen und Fenstern mit den Produkten aus der Living-Kollektion eine ganz besondere Oberfläche.

Intersteel maîtrise l'art d'associer les technologies modernes à un design élégant. Pour chaque style d'intérieur, il y a une ligne de produits qui ajoute un élément supplémentaire à la décoration. La collection Living s'associe avec beaucoup de goûts et styles: moderne/sobre, rustique/classique ou vintage/rétro. Elle est composée de produits de haute qualité dans des matériaux avec des couleurs diverses tels que l'acier inoxydable, le laiton, le nickel, le noir etc. Donnez une touche de finition personnelle à vos portes et fenêtres grâce aux produits de la collection Living.





De kwaliteit van Intersteel Living kenmerkt zich door:

- Toepasbaar in elk project, bijv. luxe woningbouw
- Keurige verpakking en geleverd inclusief bevestigingsmateriaal
- Prima prijs/kwaliteit verhouding.
- Veel referentieprojecten in Nederland, Europa, Rusland en het Midden-Oosten.

The quality of INTERSTEEL Living is characterized by:

- Suitability for any project involving homes
- Good packaging and delivery including fixing materials
- Strong price/quality ratio
- Multiple projects in the Netherlands but also abroad: in Europe, Russia and Middle Eastern countries.

Die Qualität von INTERSTEEL Essentials kennzeichnet sich aus durch:

- An jedes Objekt wie gehobenen Wohnungsbau anpassbar
- Hochwertige Verpackung inkl. Befestigungsmaterial
- Gutes Preis-/ Leistungsverhältnis
- Viele Referenzobjekte in den Niederlanden, Europa, Russland und dem mittleren Osten.

La qualité de la gamme INTERSTEEL Living se caractérise comme suit:

- Utilisable dans tout programme immobilier, du logement privé
- Emballage soigné, éléments de fixation compris
- Excellent rapport qualité / prix
- Nombreux programmes de référence aux Pays-Bas, en Europe, en Russie et jusqu'au Moyen-Orient.

Wat zijn de voordelen voor u als consument?

- Duurzaamheid
- Bewezen kwaliteit
- Eenvoudige en stevige montage door onder andere gebruik van nokken
- Inclusief bevestigingsmateriaal
- Snelle levertijd
- 10 jaar functionaliteitsgarantie.

What are the advantages for you as our customer?

- Durability
- Proven quality
- Many technical solutions
- Simple and strong assembly by means of lugs
- Including fixing materials
- Quick delivery
- Ten year warranty of functionality.

Welche Vorteile haben Sie als Verbraucher?

- Dauerhaftigkeit
- Getestete Qualität
- Einfache Montage durch Nutzung von Montagenocken
- Befestigungsmaterial im Lieferumfang enthalten
- Kurze Lieferzeiten
- 10 Jahre Funktionsgarantie

Quels sont les avantages pour le client ?

- Durabilité
- Qualité prouvée
- Installation simple et montage résistant grâce aux tenons utilisés
- Fixations fournies
- Livraison rapide
- Garantie de fonctionnement de 10 ans.

Wat zijn de voordelen voor onze dealers?

- Een duurzaam product
- Goede kwaliteit - wordt al meer dan 20 jaar volgens de huidige set up gemaakt en toegepast
- Vele technische oplossingen
- Eenvoudige en stevige montage
- Direct uit voorraad leverbaar (24 uren levering binnen Nederland)
- Goede ondersteuning door sterke INTERSTEEL merkuitstraling en professionele marketingactiviteiten
- Gezamenlijke projectbewerking (bestekservice en bezoeken)
- Gratis catalogi
- 10 jaar functionaliteitsgarantie.

What are the advantages for our dealers?

- Durability
- Good quality for over twenty years made and adapted according to the current set up
- Many technical solutions
- Simple and strong assembly
- Directly available from stock
- Support through strong INTERSTEEL brand identity and professional marketing activities
- Collaborative projects
- Free catalogues
- Ten year warranty of functionality.

Welche Vorteile haben Sie als Fachhändler?

- Ein langlebiges Produkt
- Getestete Qualität. Diese wird seit über 20 Jahren unter dem aktuellen Stand der Technik hergestellt und angewendet
- Viele technische Lösungen
- Einfache Montage durch Nutzung von Montagenocken
- Direkt ab Lager lieferbar
- Durch unsere professionelles Marketing und die starke Marke INTERSTEEL, ermöglichen wir Ihnen eine gute Vertriebsunterstützung
- Gemeinsame Projektbetreuung (Bemusterung und Besuch durch den Außendienst)
- Gratis Kataloge
- 10 Jahre Funktionsgarantie

Quels sont les avantages pour nos revendeurs?

- Durabilité de nos produits
- De bonne qualité, le concept actuel de production et d'utilisation a plus de 20 ans d'expérience.
- De nombreuses solutions techniques
- Montage simple et résistant
- Disponibilité en stock (livraison aux Pays-Bas dans les 24 heures)
- Fourniture possible de matériel publicitaire et promotionnel de la marque INTERSTEEL
- Collaboration sur des projets
- Catalogues gratuits
- Garantie de fonctionnement de 10 ans.

Onderhoud

Alle artikelen in deze catalogus zijn door gebruik, aan slijtage onderhevig. Afhankelijk van de gebruiksfrequentie en omgeving. U houdt uw beslag langer mooi door het product regelmatig af te nemen met een zachte, vochtige doek. Ondanks het feit dat veel producten uit deze catalogus als gebruiksartikelen worden beschouwd, adviseren wij u:

- Geen agressieve reinigings- of schuurmiddelen te gebruiken.
- De producten juist te monteren en correct te gebruiken. Defecten aan ramen en deuren (zoals klemmen) direct verhelpen
- Bij schuur- en schilderwerkzaamheden te allen tijde het beslag verwijderen
- Beschermende maatregelen nemen, zoals het plaatsen van deurstoppers.

Maintenance

All products in this catalogue are subject to erosion through use. Depending on the frequency of use and environment. You can keep your fittings in a good condition for longer by frequently cleaning the product with a soft, moist cloth. Although many products in this catalogue are regarded as items of everyday use, we advise you to:

- Do not use aggressive cleaners or abrasives.
- Defects onto windows and doors need direct repair
- When sanding or painting activities involved, always remove the hardware
- Always provide protective measures such as door stoppers.

Pflege

Alle Artikel aus diesem Katalog können durch den ständigen Gebrauch abnutzen. Abhängig von der Umgebung oder mechanischer Einwirkung. Ihre Beschläge bleiben länger schön, wenn Sie sie regelmäßig mit einem weichen feuchten Tuch abwischen. Ungeachtet der Tatsache, dass viele Produkte in diesem Katalog als Gebrauchsartikel anzusehen sind, raten wir Ihnen:

- Keine aggressiven Reinigungsmittel und keine Schleifmittel.
- Mängel von Fenstern und Türen sofort beseitigen
- Bei Schleif- und Malerarbeiten bitten den Beschlag entfernen
- Platzierung eines Türstoppers bitte gut planen.

Entretien

Tous les articles présentés dans ce catalogue sont soumis à l'usure. A la longue, suivant le maniement ou l'environnement. Le produit doit être régulièrement entretenu avec un chiffon humide; une fois par semaine suffira dans la plupart des cas.













- Ne pas utiliser de détergents agressifs ou abrasifs
- En cas de fenêtres ou de portes endommagées (frottement) y remédier au plus vite
- En cas de ponçage ou de peinture, démonter les garnitures complètement
- Prendre des mesures de protection, comme placer des butoirs, par exemple.

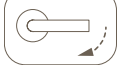
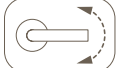

Index - artikelgroepen

	0010. Messing ongelakt Brass unlacquered Messing unlackiert Laiton non verni	0011. Messing getrommeld Brass vibrated Messing Natur Laiton vielli	0013. Messing gelakt Brass lacquered Messing lackiert Laiton verni	0021. Oud grijs Old grey Alt grau Vieux gris	0024. Messing gebruint Brass antique Messing bruniert Laiton bronzé	0050. Messing titanium Brass titanium Messing Titanium Titan laiton poli
Binnendeurbeslag - Losse krukken en accessoires Interior door hardware - Door handles and accessories Innentürbeschläge - Türdrucker und Zubehör Garnitures de porte intérieure - Béquilles et accessoires	11	43	79	167	197	-
Binnendeurbeslag - Rond / Ovaal Interior door hardware - Round / Oval Innentürbeschläge, Festdrehbar - Rund / Oval Garnitures de porte intérieure - Ronde / Ovale	-	51	91	173	201	231
Binnendeurbeslag - Vierkant Interior door hardware - Square Innentürbeschläge - Eckig Garnitures de porte intérieure - Carrée	-	53	101	-	-	-
Buitendeurbeslag - Rond / Ovaal Exterior door hardware - Round / Oval Türbeschläge - Rund / Oval Garnitures de porte extérieure - Rond / Ovale	15	57	105	177	203	235
Buitendeurbeslag - Vierkant Exterior door hardware - Square Hautürbeschläge - Eckig Garnitures de porte extérieure - Carrée	23	63	115	183	211	-
Buitendeurbeslag - Huiscijfers Exterior door hardware - House numbers Türbeschläge - Hausnummern Garnitures de porte extérieure - Numéros de maison	-	69	121	-	215	243
Raambeslag - Raamkrukken en -sluitingen Window fittings - Window handles and closers Fensterbeschläge - Fenstersicherung Garnitures de fenêtre - Béquilles de fenêtre	29	71	125	185	217	-
Toebehoren - Espagnoletten Accessories - Espagnolette Zubehör - Espagnolette Accessoires - Espagnolette	31	-	135	-	221	-
Toebehoren - Sierhulzen Accessories - Hinge covers Zubehör - Übersteckhüls Accessoires - Caches-paumelles	-	-	143	187	-	-
Toebehoren - Deurstoppers Accessories - Doorstops Zubehör - Türstopper Accessoires - Butoirs de porte	37	-	145	189	-	-
Toebehoren - Schuifdeurbeslag Accessories - Sliding door fittings Zubehör - Schiebetürbeschläge Accessoires - Ferrures de portes coulissantes	-	-	147	-	-	-
Toebehoren - Deurgrepen Accessories - Pull handles Zubehör - Stoßgriffe Accessoires - Tirants	39	-	149	191	-	-
Toebehoren - Meubelgrepen Accessories - Furniture handles Zubehör - Möbelgriffe Accessoires - Poignées de meuble	41	77	151	193	225	-
Toebehoren - Garderobe Accessories - Coat rack Zubehör - Garderoben Accessoires - Porte-manteaux	-	-	157	-	229	-
Toebehoren - Leuninghouders Accessories - Handrail holders Zubehör - Handlaufstützen Accessoires - Supports de rampe	-	-	161	-	-	-
Toebehoren - Deurspionnen Accessories - Doorviewers Zubehör - Türspionen Accessoires - Judas de porte	-	-	165	-	-	-

Legenda - Index - Legende - Légende

	Compleet paar	Complete pair	Komplett Garnitur	Par paire
	Gatdeel rechts	Single Door handle right	Lochteil rechtszeigend	Demi paire droite
	Gatdeel links	Single Door handle left	Lochteil linkszeigend	Demi paire gauche
	Knopkruk	Knob handle	Knopf	Bouton fixe
	Blind	Blind	Blind	Aveugle
	Geheel blind	Without holes	Komplett Blind	Complètement aveugle
	Sleutelgat (SL)	Keyhole	Buntbart (BB)	Clé à gorge (BB)
	Profielcilinder (PC)	Profile cylinder	Profilzylinder	Clé à cylindre (PZ)
	Rondcilinder (RC)	Round cylinder	Rundzylinder	Clé à cylindre rond (RC)
	WC-sluiting met venster	Privacy with window	Bad/WC	Fermeture WC avec fenêtre
	WC-sluiting zonder venster	Privacy without window	Bad/WC ohne Fenster	Fermeture WC sans fenêtre
	Bevestigingsmateriaal	Fixing materials	Befestigungsmaterial	Fixations
	Vast draaibaar enkel geveerd	Fixed single rotatable	Festdrehbar	Sertie sur rosace avec ressort
	Vast draaibaar dubbel geveerd	Fixed double rotatable	Doppel gefedert	Sertie sur rosace avec double ressorts
	Deurdikte	Door thickness	Türstärke	Épaisseur de porte
	SKG ***	SKG ***	SKG ***	SKG ***
	SKG *	SKG *	SKG *	SKG *
	Politie Keurmerk Veilig Wonen	Approval by police	Polizei Geprüft	Approbation par la Police
	Functionaliteits garantie	Operational guarantee	Garantie auf die Funktion	Garantie de fonctionnalité
	Garantie op de finish	Varnish guarantee	Garantie auf die Lackschicht	Garantie sur la finition
	Nederlandse Eenheidsnorm	Dutch standard	Holländische Standardnorm	Norm Néerlandaise



Messing ongelakt - Brass unlacquered

Messing unlackiert - Laiton non verni

Binnendeurbeslag - Losse krukken

0010

Interior door hardware - Door handles

Innentürbeschläge - Türdrucker

Garnitures de porte intérieure - Bequilles

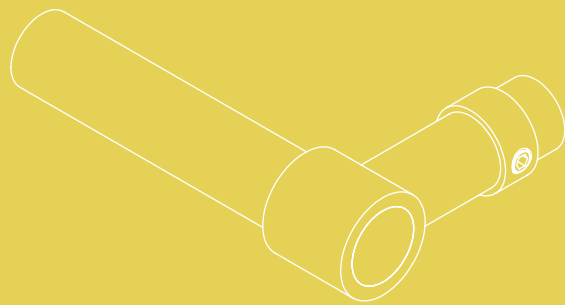

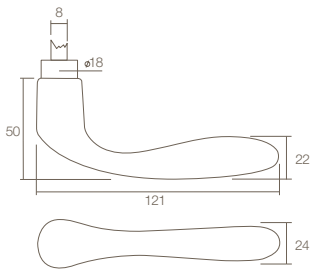

0010.020100

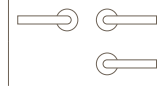

0010.020100A



0201

0010.020100

Deurkruk Banaan. Messing ongelakt.



Door handle Banaan. Brass unlacquered.



Türdrücker Banaan. Messing unlackiert.

Béquille Banane. Laiton non verni.

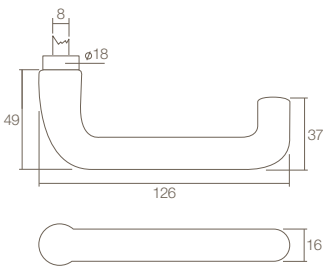

0010.023400

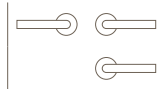

0010.023400A



0234

0010.023400

Deurkruk Rond. Messing ongelakt.



Door handle round. Brass unlacquered.



Türdrücker rund. Messing unlackiert.

Béquille modèle U. Laiton non verni.

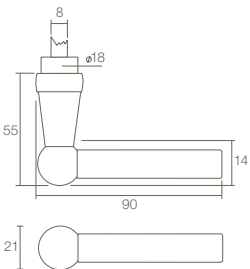

0010.032300

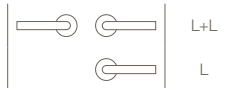

0010.032300A



0323

0010.032300

Deurkruk L/L-model. Messing ongelakt.



Door handle L/L model. Brass unlacquered.



Türdrücker L/L-Modell. Messing unlackiert

Béquille modèle L/L. Laiton non verni.

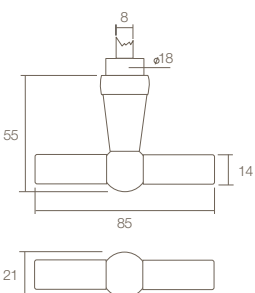

0010.032400

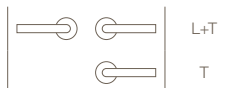

0010.032400A



0324

0010.032400

Deurkruk L/T-model. Messing ongelakt.



Door handle L/T model. Brass unlacquered.



Türdrücker L/T-Modell. Messing unlackiert

Béquille modèle L/T. Laiton non verni.

Accessoires Accessories Zubehör



0010.318604



0010.318616



0010.318617



0010.318660



0010.370001



0010.322004

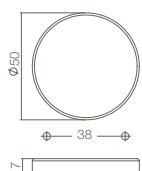

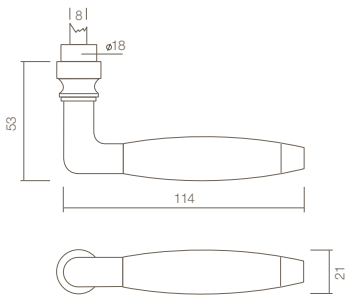

0010.037100

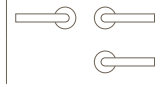

0010.037100A



0371

0010.037100

Deurkruk Marloes. Messing ongelakt/ebbenhout.



Door handle Marloes. Brass unlacquered/ebony.



Türdrücker Marloes. Messing unlackiert/Ebenholz.

Béquille Marloes. Laiton non verni/bois d'ébène.

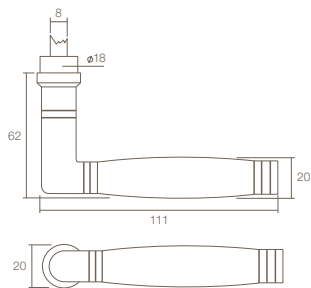

0010.037500

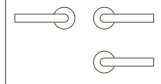

0010.037500A



0375

0010.037500

Deurkruk Ton 222. Messing ongelakt/ebbenhout.



Door handle Ton 222. Brass unlacquered/ebony.



Türdrücker Ton 222. Messing unlackiert/Ebenholz.

Béquille Ton 222. Laiton non verni/bois d'ébène.

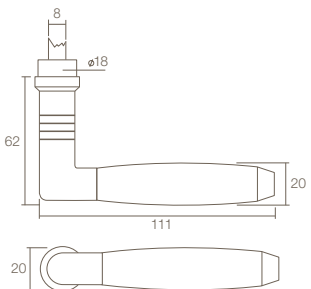

0010.037700

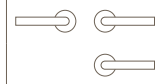

0010.037700A



0377

0010.037700

Deurkruk Ton 400. Messing ongelakt/ebbenhout.



Door handle Ton 400. Brass unlacquered/ebony.



Türdrücker Ton 400. Messing unlackiert/Ebenholz.

Béquille Ton 400. Laiton non verni/bois d'ébène.

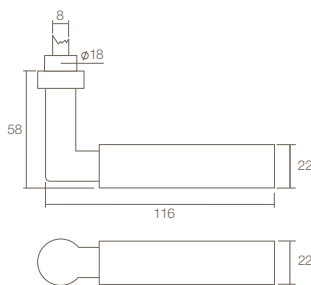

0010.037800

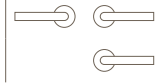

0010.037800A



0378

0010.037800

Deurkruk Bau-stil. Messing ongelakt.



Door handle Baustil. Brass unlacquered.



Türdrücker Baustil. Messing unlackiert.

Béquille Bau-stil. Laiton non verni.

Accessoires

Accessories
Zubehör

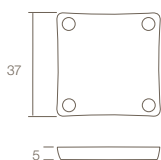

0010.318304



0010.318316



0010.318317



0010.318360



8mm

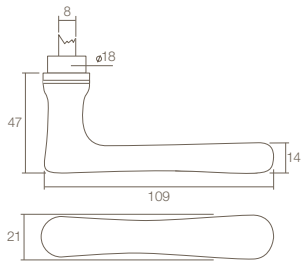

0010.038800

0010.038800A

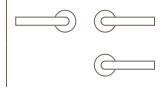

0388

0010.038800

Deurkruk Trento. Messing ongelakt.



Door handle Trento. Brass unlacquered.



Türdrücker Trento. Messing unlackiert.

Béquille Trento. Laiton non verni.

Accessoires
Accessories
Zubehör



0010.318604



0010.318616



0010.318617



0016.318660

8mm \varnothing



0010.370001



0010.322004

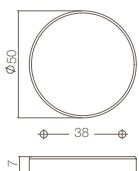

Messing ongelakt - Brass unlacquered

Messing unlackiert - Laiton non verni

Buitendeurbeslag - Rond / Ovaal

0010

Exterior door hardware - Round / Oval

Haustürbeschläge - Rund / Oval

Garnitures de porte extérieure - Ronde / Ovale

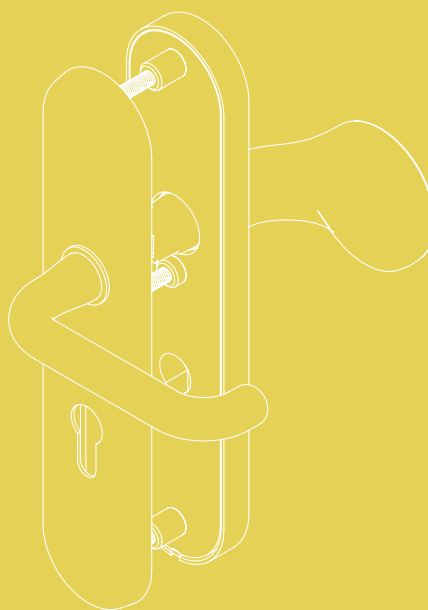

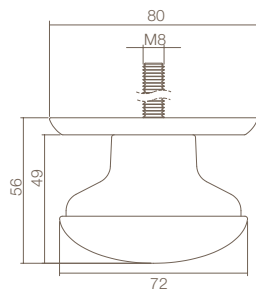
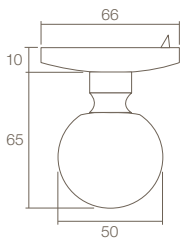
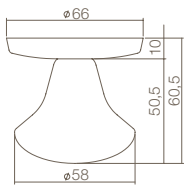

3930

0010.393030 Voordeurknop Paddenstoel vast ϕ 58/66mm. Doorgaande bevestiging M8. Messing ongelakt.



Front door knob mushroom ϕ 58/66 mm not turnable with bolt one side fixing M8. Brass unlacquered.

Haustürknoopf Pilz ϕ 58/66mm fest mit einseitiger Befestigung M8. Messing unlackiert.

Bouton d'entrée fixe Champignon ϕ 58/66mm. Fixation traversante M8. Laiton non verni.



3930

0010.393031 Voordeurknop vast bolrond ϕ 50/66mm. Doorgaande bevestiging M8. Messing ongelakt.



Front door knob round ϕ 50/66mm. Not turnable with bolt. One side fixing M8. Brass unlacquered.

Haustürknoopf kugelrund ϕ 50/66mm mit einseitiger Befestigung M8. Messing unlackiert.

Bouton d'entree fixe petite boule ϕ 50/66mm. Fixation traversante M8. Laiton non verni.



3930

0010.393033 Voordeurknop zwaar vast ϕ 72/80mm. Doorgaande bevestiging M8. Messing ongelakt.



Front door knob heavy ϕ 72/80mm. Not turnable with bolt. One side fixing M8. Brass unlacquered.

Haustürknoopf schwer ϕ 72/80mm fest mit einseitiger Befestigung M8. Messing unlackiert.

Bouton d'entree fixe grande ϕ 72/80mm. Fixation traversante M8. Laiton non verni.

Accessoires

Accessories

Zubehör



0099.997470



Schroefdraad met rvs eindkap t.b.v. bevestiging voordeurknop. 304 RVS geborsteld.

Change spindle for front door knob, including a cover plate. 304 brushed stainless steel.

Gewindesttift mit Hutmutter für Haustürknoopf. Edelstahl 304 gebürstet.

Fixation traversante pour bouton d'entrée. Inox mat AISI 304.

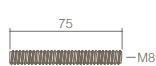

0010.397500

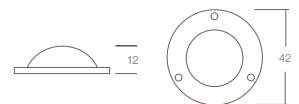

Afdekkplaatje t.b.v. bout. messing ongelakt.

Bolt cover plate. Brass unlacquered.

Abdeckplatte für Bolzen. Messing unlackiert.

Ce cache boulon couvre la vis du bouton. Laiton non verni.

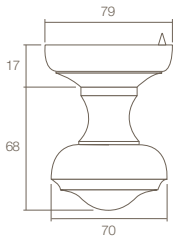

3930

0010.393034

Voordeurknop Venere vast $\varnothing 70/79$ mm.
Doorgaande bevestiging M8.
Messing ongelakt.



Front door knob Venere $\varnothing 70/79$ mm. Not turnable
with bolt. One side fixing M8.
Brass unlacquered.

Haustürknoopf Venere $\varnothing 70/79$ mm. Fest mit
einseitiger Befestigung M8.
Messing unlackiert.

Bouton d'entree fixe Venere $\varnothing 70/79$ mm.
Fixation traversante M8. Laiton non verni.

Accessoires

Accessories

Zubehör



0099.997470



Schroefdraad met rvs eindkap t.b.v. bevestiging voordeurknop.
304 RVS geborsteld.

Change spindle for front door knob, including a cover plate.
304 brushed stainless steel.

Gewindesttift mit Hutmutter für Haustürknoopf.
Edelstahl 304 gebürstet.

Fixation traversante pour bouton d'entrée.
Inox mat AISI 304.

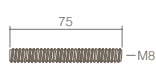

0010.397500

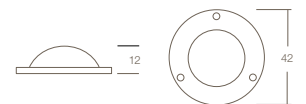

Afdekplaatje t.b.v. bout, messing ongelakt.

Bolt cover plate. Brass unlacquered.

Abdeckplatte für Bolzen.
Messing unlackiert.

Ce cache boulon couvre la vis du bouton.
Laiton non verni.

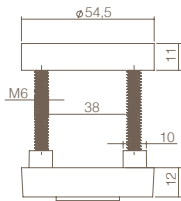
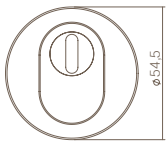

0010.375100

M6



3751

0010.375100

PC veiligheidsrozet rond verdekt met kerntrekbeveiliging. M6. Messing ongelakt.



Security euro profile cylinder escutcheon round with cylinder protection. With invisible fixing M6. Brass unlacquered.



PZ Schutzrosette verdeckt Rund, mit Kernziehschutz. M6. Messing unlackiert.



Entrée de cylindre de haute sécurité ronde avec cache anti-forage. Fixation invisible. M6. Laiton non verni.

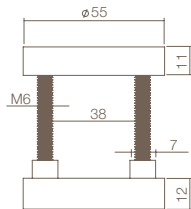
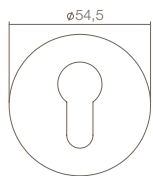

0010.375060

M6



3750

0010.375060

PC veiligheidsrozet rond verdekt. M6. Messing ongelakt.



Security euro profile cylinder escutcheon. With invisible fixing. M6. Brass unlacquered.



PZ Schutzrosette verdeckt. M6. Messing unlackiert.



Entrée de cylindre de sécurité ronde. Fixation invisible. M6. Laiton non verni.

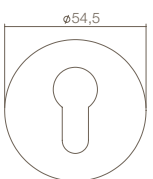

3751



0016.375130

Afde krozet binnenzijde rond. Messing ongelakt.



Euro profile cylinder escutcheon round. Brass unlacquered.

Schutzrosette Rund. Messing unlackiert.

Ce cache rosace. Couvre la cylindre de haute sécurité à l'intérieur. Laiton non verni.

Accessoires

Accessories
Zubehör



0099.990120	M6	70mm	58 - 64
0099.990122	M6	80mm	68 - 74
0099.990121	M6	90mm	78 - 84

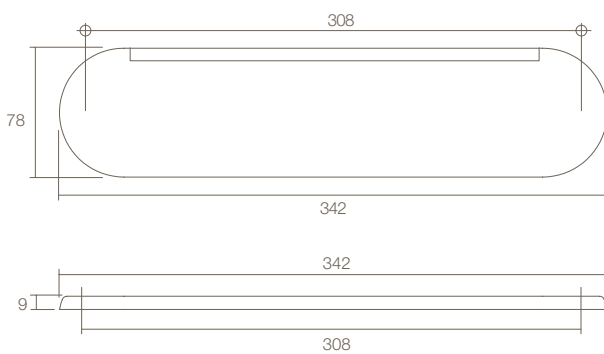
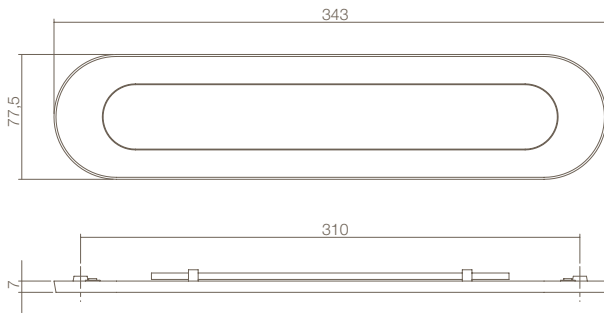

4000



0010.400005 Briefplaat ovaal met veer. Zowel horizontaal als verticaal te monteren. Messing ongelakt.



Springloaded oval letter plate. Can be mounted both horizontally and vertically. Brass unlacquered.



Briefeinwurf oval mit Feder. Kann sowohl horizontal und vertikal montiert werden. Messing unlackiert.

Plaque-a-lettres ovale avec ressort. Pose horizontal ou vertical. Laiton non verni.

4015



0010.401500 Tochtwering ovaal met borstel en afdekklep. Messing ongelakt.



Oval draught flap with brush and rain edge. Brass unlacquered.



Zugklappe oval mit Bürstenleise und Abdeckklappe verdeckt. Messing unlackiert.

Plaque-a-lettres anti courants d'air, ovale, avec clapet. Laiton non verni.

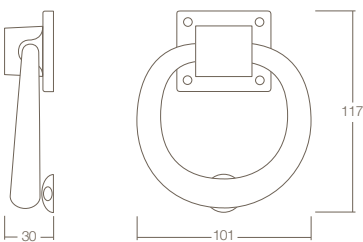
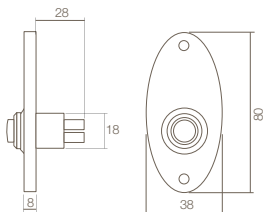
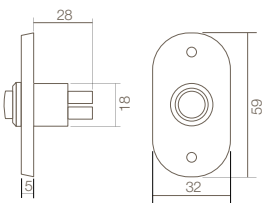
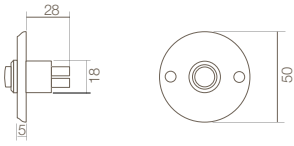

3990

0010.399023

Beldrukker rond. Opschroevend.
Messing ongelakt.



Round bell push. Screw mounting.
Brass unlacquered.

Klingelplatte rond. Schraubbar.
Messing unlackiert.

Sonnette ronde. Fixation visible.
Laiton non verni.



3992

0010.399025

Beldrukker ovaal. Opschroevend.
Messing ongelakt.



Oval bell push. Screw mounting.
Brass unlacquered.

Klingelplatte ovaal. Schraubbar.
Messing unlackiert.

Sonnette ovale. Fixation visible.
Laiton non verni.



3992

0010.399028

Beldrukker Ellips. Opschroevend.
Messing ongelakt.



Bell push Ellips. Screw mounting.
Brass unlacquered.

Klingelplatte Ellipse. Schraubbar.
Messing unlackiert.

Sonnette Ellipse. Fixation visible.
Laiton non verni.



4035

0010.403500

Deurklopper rond. Messing ongelakt.



Doorknocker round. Brass unlacquered.

Türklopper rund. Messing unlackiert.

Heurtoir de porte rond. Laiton non verni.

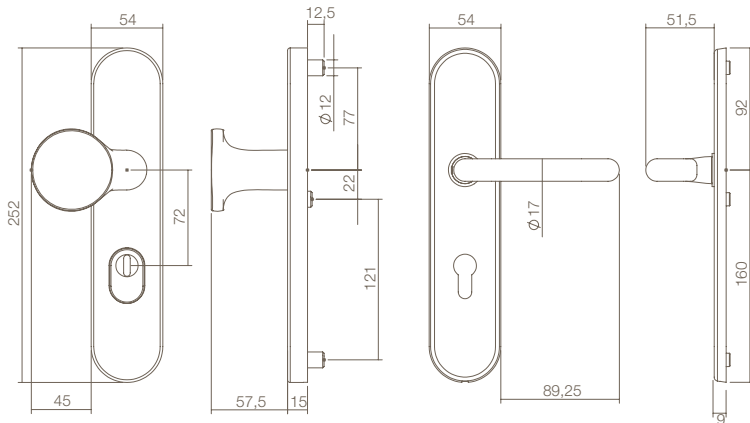

0010.382029		55mm
0010.382036		72mm
0010.382049		92mm



3820

0010.382036

PC veiligheidschilden met kerntrekbeveiliging greep/kruk los. Krukhals \varnothing 18mm. Links of rechts te monteren. Stift M14 x 8 x 75mm. Messing ongelakt.



Security plates pull/lever with cylinder protection. Pull is reversible. Insert \varnothing 18mm. Spindle M14 x 8 x 75mm. Brass unlacquered.

Sicherheitsgarnitur Drücker/Griffplatte mit Kernziehschutz. Rechts/links verwendbar. Drücker Hals \varnothing 18mm. Stift M14 x 8 x 75mm. Messing unlackiert.

Garnitures de sécurité avec cache anti-forage et tirant fixe. Tirant réversible. Béquille seule, cou de \varnothing 18mm, droite ou gauche. Tige M14 x 8 x 75mm. Laiton non verni.

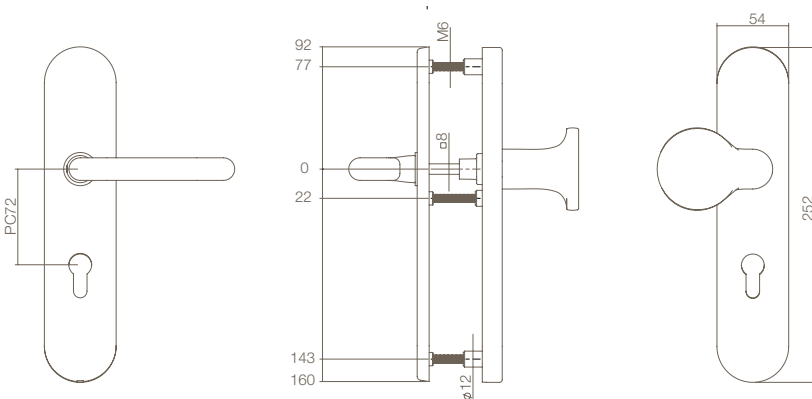

0010.384629		55mm
0010.384636		72mm
0010.384649		92mm



3846

0010.384636

PC veiligheidschilden greep/kruk los. Krukhals \varnothing 18mm. Links of rechts te monteren. Stift M14 x 8 x 75mm. Messing ongelakt.



Security plates pull/lever. Pull is reversible. Insert \varnothing 18mm. Spindle M14 x 8 x 75mm. Brass unlacquered.

Sicherheitsgarnitur Drücker/Griffplatte. Rechts/links verwendbar. Drücker Hals \varnothing 18mm. Stift M14 x 8 x 75mm. Messing unlackiert.

Garnitures de sécurité. Tirant réversible. Béquille seule, cou de \varnothing 18mm, droite ou gauche. Tige M14 x 8 x 75mm. Laiton non verni.

Accessoires

Accessories
Zubehör



0099.990120	M6	70mm	58 - 64
0099.990122	M6	80mm	68 - 74
0099.990121	M6	90mm	78 - 84



0099.975343	M14	\square 8x75mm	\leq 42
0099.975363	M14	\square 8x90mm	\leq 60
0099.975364	M14	\square 8x120mm	\leq 90

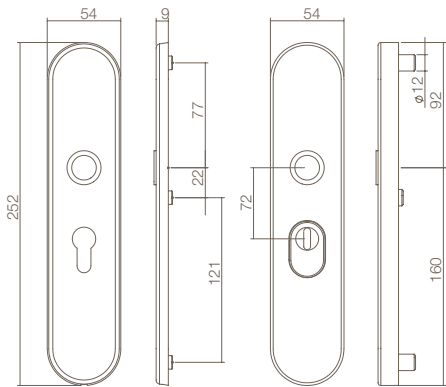

0010.382129		55mm
0010.382136		72mm
0010.382149		92mm

- Optie:** Te combineren met deurkrukken op pagina 12-14.
- Option:** Combine with doorhandles from page 12-14.
- Option:** Zu kombinieren mit Türdrücker auf Seite 12-14.
- Option:** Une combinaison possible avec les béquilles de la page 12-14.

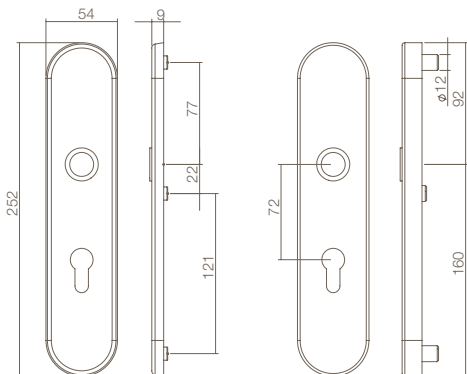

0010.381929		55mm
0010.381936		72mm
0010.381949		92mm

- Optie:** Te combineren met deurkrukken op pagina 12-14.
- Option:** Combine with doorhandles from page 12-14.
- Option:** Zu kombinieren mit Türdrücker auf Seite 12-14.
- Option:** Une combinaison possible avec les béquilles de la page 12-14.

3821



0010.382136

PC veiligheidsschilden doorgaand met kerntrekbeveiliging. Krukhals $\phi 18$ mm. Messing ongelakt.



Security plates with cylinder protection. Insert $\phi 18$ mm. Brass unlacquered.

Schutzbeschlag mit Kernziehschutz. Drücker Hals $\phi 18$ mm. Messing unlackiert.

Garnitures de sécurité avec cache anti-forage. Béquille, cou de $\phi 18$ mm. Laiton non verni.

3819



0010.381936

Veiligheidsschilden doorgaand. Krukhals $\phi 18$ mm. Messing ongelakt.



Security plates. Insert $\phi 18$ mm. Brass unlacquered.

Schutzbeschlag durchgehend. Drücker Hals $\phi 18$ mm. Messing unlackiert.

Garnitures de sécurité. Béquille, cou de $\phi 18$ mm. Laiton non verni.

Accessoires

Accessories
Zubehör



0099.990120	M6	70mm	58 - 64	0099.975000	\square 8x105mm	≤ 42
0099.990122	M6	80mm	68 - 74	0099.975001	\square 8x120mm	≤ 58
0099.990121	M6	90mm	78 - 84	0099.975002	\square 8x150mm	≤ 90

Messing ongelakt - Brass unlacquered

Messing unlackiert - Laiton non verni

Buitendeurbeslag - Vierkant

0010

Exterior door hardware - Square

Haustürbeschläge - Eckig

Garnitures de porte extérieure - Carrée

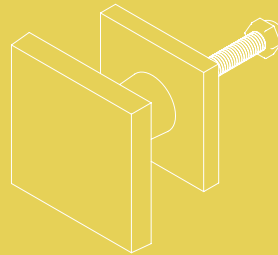

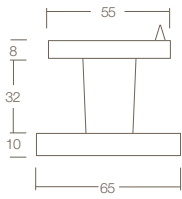

0010.393046 | | M8



3930

0010.393046 Voordeurknop vierkant vast centraal 65/55mm. Doorgaande bevestiging M8. Messing ongelakt.



Front door knob square central fixed 66/55mm. Bolt through fixing M8. Brass unlacquered.

Haustürknoopf fest eckig 65/55mm mit durchgehender Befestigung M8. Messing unlackiert.

Bouton d'entree central fixe carree 65/55mm. Fixation traversante M8. Laiton non verni.

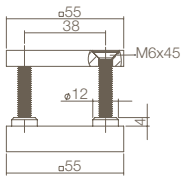

0010.375140 | | M8



3751

0010.375140 PC veiligheidsrozet massief vierkant. Zichtbare bevestiging. Messing ongelakt.



Square euro profile cylinder. With visible fixing. Brass unlacquered.



PZ Schuturosette eckig. Mit sichtbarer Befestigung. Messing unlackiert.



Entrée de cylindre de sécurité massive carrée. Fixation visible M6. Laiton non verni.

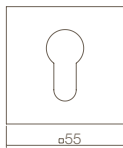

Accessoires

Accessories

Zubehör



0099.997470

Schroefdraad met rvs eindkap t.b.v. bevestiging voordeurknop. 304 RVS geborsteld.

Change spindle for front door knob, including a cover plate. 304 brushed stainless steel.

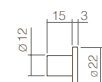

Gewindesttift mit Hutmutter für Haustürknoopf. Edelstahl 304 gebürstet.

Fixation traversante pour bouton d'entrée. Inox mat AISI 304.



0099.990140



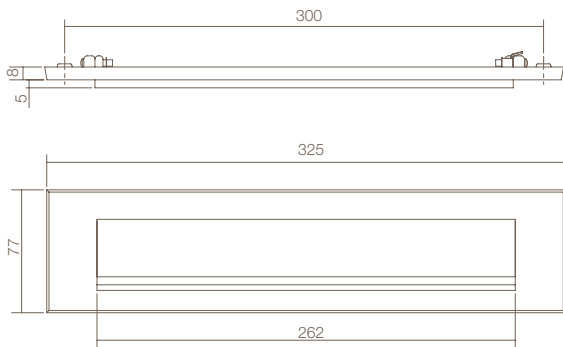

0010.400001

Briefplaat rechthoekig met regenrand.
Klep half naar buitendraaiend.
Messing ongelakt.



Letter plate square with rain edge, opens
half outwards. Brass unlacquered.



Briefeinwurf rechteckig mit Tropfkante.
Klappe halb nach aussen öffnend.
Messing unlackiert.

Plaque-à-lettres rectangulaire. S'ouvrant à
moitié vers l'extérieur. Laiton non verni.

4000

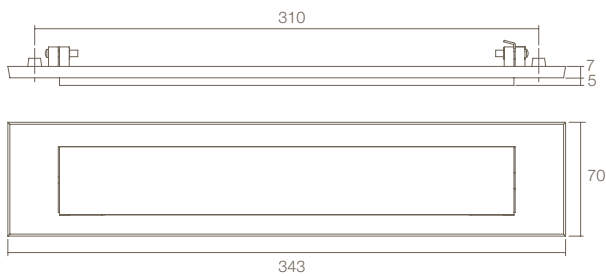

0010.400003

Briefplaat rechthoekig. Klep half naar
buitendraaiend. Messing ongelakt.



Letter plate square with flap. Opens half outwards.
Brass unlacquered.



Briefeinwurf rechteckig mit Klappe. Klappe halb
nach aussen öffnend. Messing unlackiert.

Plaque-à-lettres rectangulaire.
S'ouvrant à moitié vers l'extérieur.
Laiton non verni.

4000

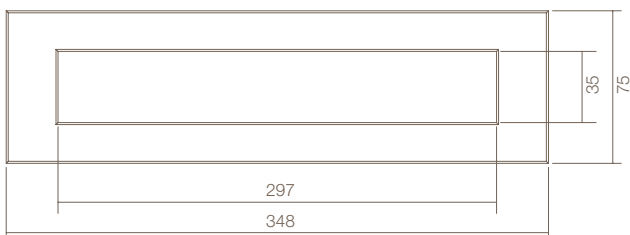

0010.400004

Briefplaat rechthoekig met veer. Klep half naar
binnen draaiend. Zowel horizontaal als verticaal
te monteren. Messing ongelakt.



Square springloaded letter plate. Opens half
inwards. Can be mounted both horizontally and
vertically. Brass unlacquered.



Briefeinwurf rechteckig mit feder. Klappe halb
nach innen öffnend. Kann sowohl horizontal und
vertikal montiert werden. Messing unlackiert.

Plaque-a-lettres rectangulaire avec ressort.
Pose horizontal ou vertical. Laiton non verni.

4000



0010.401503

Tochtwering rechthoekig met borstel.
Messing ongelakt.



Draught flap rectangular with brush.
Brass unlacquered.

Zugklappe rechteckig mit Bürstenleiste.
Messing unlackiert.

Plaque-a-lettres rectangulaire anti courants
d'air avec brosse. Laiton non verni.

4015

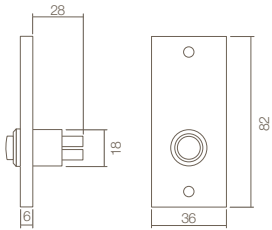
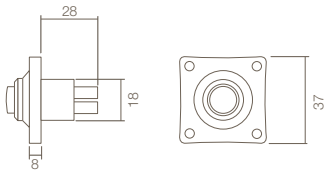

3990

0010.399029

Beldrukker vierkant klein. Opschroevend.
Messing ongelakt.



Square bell push. Screw mounting.
Brass unlacquered.

Klingelplatte eckig. Schraubbar.
Messing unlackiert.

Sonnette carree petite. Fixation visible.
Laiton non verni.



3990

0010.399032

Beldrukker rechthoekig. Opschroevend.
Messing ongelakt.



Square bell push small. Screw mounting.
Brass unlacquered.

Klingelplatte eckig smal. Schraubbar.
Messing unlackiert.

Sonnette rectangulaire. Fixation visible.
Laiton non verni.

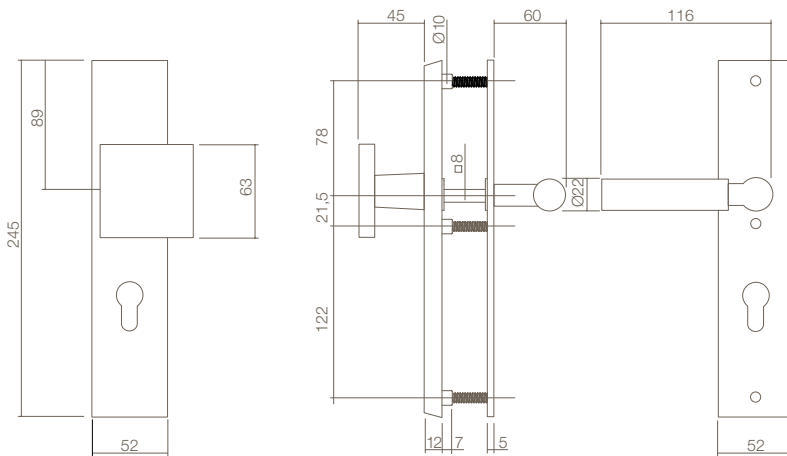

0010.382436 | | 72mm

0010.382449 | | 92mm



3824

0010.382436

PC veiligheidschilden rechthoekig massief. Greep/kruk los. Krukhals \varnothing 18mm. Links of rechts te monteren. Stift M14 x 8 x 75mm. Messing ongelakt.



Security plates rectangular pull/lever. Pull is reversible. Insert \varnothing 18mm. Spindle M14 x 8 x 75mm. Brass unlacquered.

Sicherheitsgarnitur rechteckig Drücker/Griffplatte. Rechts/links verwendbar. Drücker Hals \varnothing 18mm. Stift M14 x 8 x 75mm. Messing unlackiert.

Garnitures de sécurité rectangulaire. Tirant réversible. Béquille seule, cou de \varnothing 18mm, droite ou gauche. Tige M14 x 8 x 75mm. Laiton non verni.

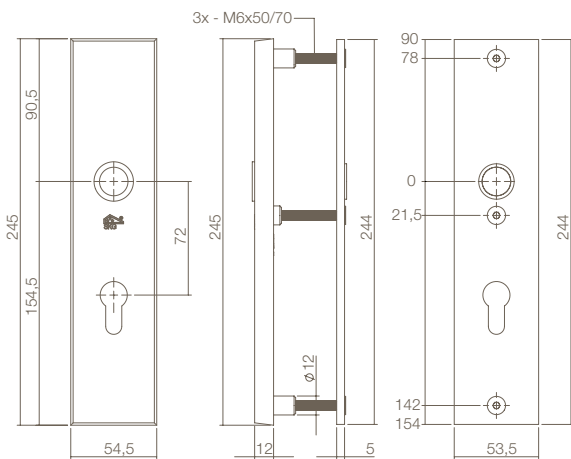

Optie: Te combineren met deurkrukken op pagina 12-14. 0010.382529 | | 55mm

Option: Combine with doorhandles from page 12-14. 0010.382536 | | 72mm

Option: Zu kombinieren mit Türdrücker auf Seite 12-14. 0010.382549 | | 92mm

Option: Une combinaison possible avec les béquilles de la page 12-14.



3825

0010.382536

PC veiligheidschilden rechthoek massief doorgaand. Krukhals \varnothing 18mm. Messing ongelakt.



Security plates rectangular solid. Insert \varnothing 18mm. Brass unlacquered.

Schutzbeschlag rechteckig durchgehend. Drücker Hals \varnothing 18mm. Messing unlackiert.

Garniture de sécurité rectangulaire massive. Béquille, cou de \varnothing 18mm. Laiton non verni.

Accessoires

Accessories
Zubehör



0099.990140



M6



90mm



78 - 84



0099.975343



M14

 \square 8x75mm \leq 42

0099.975363

M14

 \square 8x90mm \leq 60

0099.975364

M14

 \square 8x120mm \leq 90

0099.975000

 \square 8x105mm \leq 42

0099.975001

 \square 8x120mm \leq 58

0099.975002

 \square 8x150mm \leq 90



Messing ongelakt - Brass unlacquered

Messing unlackiert - Laiton non verni

Raambeslag - Raamsluitingen

0010

Window fittings - Window closers

Fensterbeschläge - Fenstersicherung

Garnitures de fenêtres - Béquille de fenêtre



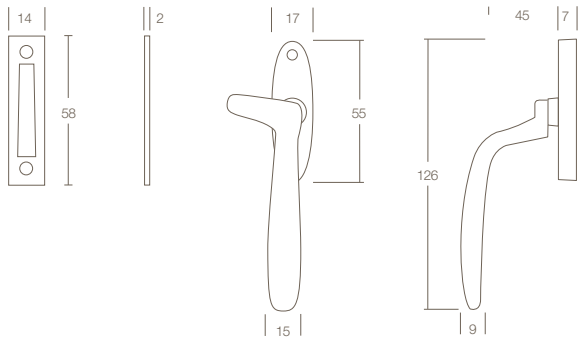

0010.561550A



0010.561550B

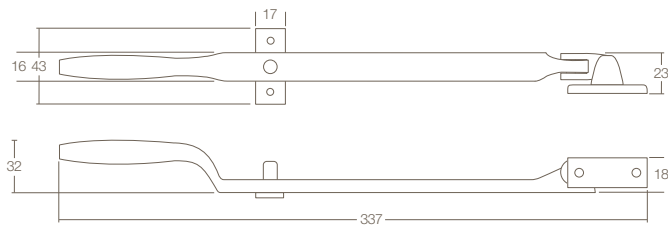

5615



0010.561550A Raamsluiting Dudok. Messing ongelakt.



Window closure Dudok. Brass unlacquered.

Fensterschließer Dudok. Messing unlackiert.

Cremona Dudok. Laiton non verni.

5615



0010.561580 Raamuitzetter Dudok met stelpen.
Messing ongelakt.



Window casement stay. With casement
stay pin. Brass unlacquered.

Fensteraufsteller mit Stellstift.
Messing unlackiert.

Entrebailleur Dudok avec cheville de
positionnement. Laiton non verni.

Messing ongelakt - Brass unlacquered

Messing unlackiert - Laiton non verni

Toebehoren - Espagnoletten

0010

Accessories - Espagnolette

Zubehör - Espagnolette

Accessoires - Espagnolette



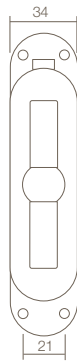
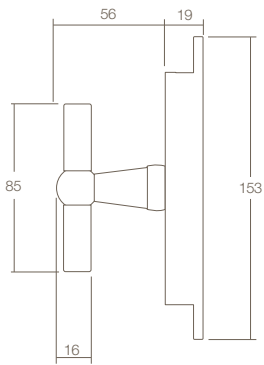

5620



0010.562020

Espagnolet T-kruk. Messing ongelakt.



Espagnolette T-Modell. Messing unlackiert.

Espagnolette T-Modell. Messing unlackiert.

Crémone kit "T" . Laiton non verni.

Accessoires

Accessories
Zubehör



0010.562000



0010.562001

0010.562007
2 x 125cm

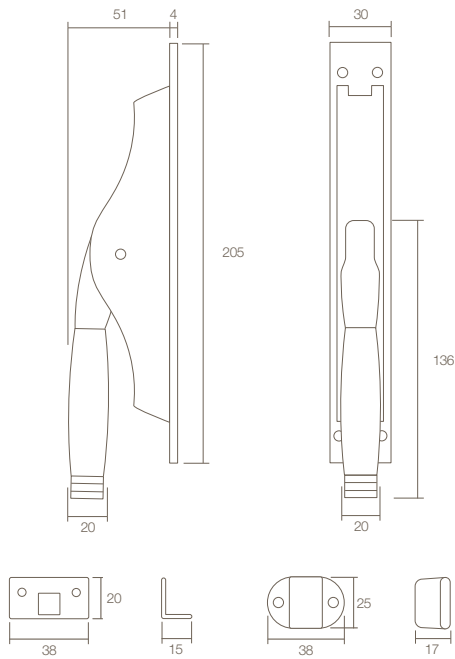

5620



0010.562035

Pomp-espagnolet Ton 222.
Messing ongelakt/ebbenhout.



Pump espagnolet Ton 222.
Brass unlacquered/ebony.

Pump-Espagnolet Ton 222.
Messing unlackiert/Ebenholz.

Espagnolette a levier Ton 222
Laiton non verni/bois d'èbène.

Accessoires

Accessories
Zubehör



0010.562000



0010.562001



0010.562004
2 x 125cm

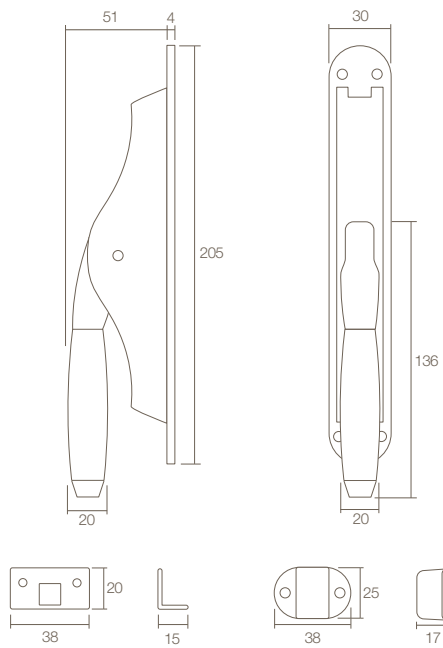

5620



0010.562036

Pomp-espagnolet Ton 400.
Messing ongelakt/ebbenhout.



Pump espagnolet Ton 400
Brass unlacquered/ebony.

Pump-Espagnolet Ton 400.
Messing unlackiert/Ebenholz.

Espagnolette a levier Ton 400.
Laiton non verni/bois d'èbène.

Accessoires

Accessories
Zubehör



0010.562000



0010.562001



0010.562004
2 x 125cm

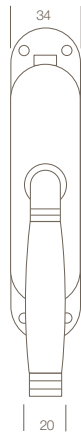
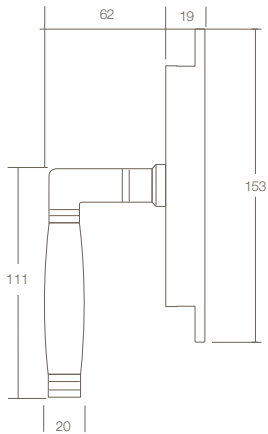

0010.562060A

0010.562060B

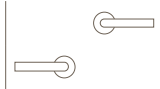

5620

0010.562060

Kruk-espagnolet Ton 222.
Messing ongelakt/ebbenhout.Handle espagnolet Ton 222.
Brass unlacquered/ebony.Klinken-Espagnolet Ton 222.
Messing unlackiert/Ebenholz.Cremone kit Ton 222.
Laiton non verni/bois d'ébène.

Accessoires

Accessories
Zubehör



0010.562000



0010.562001

0010.562007
2 x 125cm

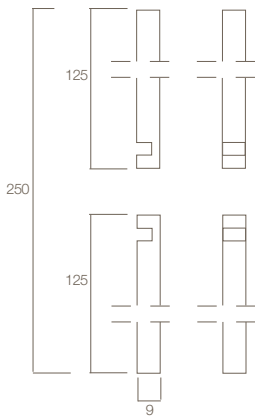

5620

0010.562004

Stangenset tbv pomp-espagnolet 125cm.
Messing gelakt.



Bar set for pump espagnolet. Brass lacquered.

Stangensatz für Pump-Espagnolet.
Messing lackiert.

Paire de tringles pour espagnolette à levier
2x125cm. Laiton verni.

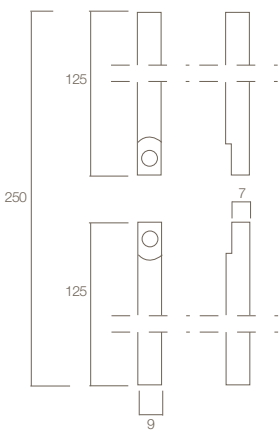

5620

0010.562007

Stangenset tbv kruk-espagnolet lang
125cm. Messing gelakt.



Bar set for handle espagnolet. Brass lacquered.

Stangensatz für Klinken-Espagnolet.
Messing lackiert.

Paire de tringles pour crémono/espagnolette
2x125cm. Laiton verni.

Accessoires

Accessories
Zubehör



0010.562000



0010.562001

Messing ongelakt - Brass unlacquered

Messing unlackiert - Laiton non verni

Toebehoren - Deurstoppers

0010

Accessories - Doorstops

Zubehör - Türstopper

Accessoires - Butoirs de porte

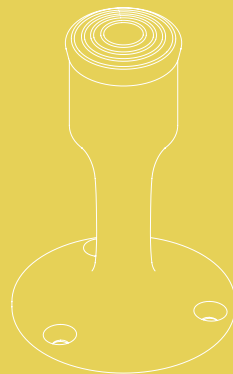

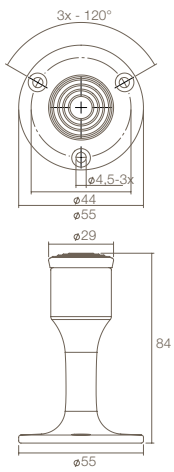

4420

0010.442040 Deurstop recht model. Wandmontage.
 Messing ongelakt.



Doorstop straight. Wall mounting.
 Brass unlacquered.

Türstopper recht. Wandmontage.
 Messing unlackiert.

Butoir modele droit. Pose mural.
 Laiton non verni.

Messing ongelakt - Brass unlacquered

Messing unlackiert - Laiton non verni

Toebehoren - Deurgrepen

0010

Accessories - Pull handles

Zubehör - Stoßgriffe

Accessoires - Tirants



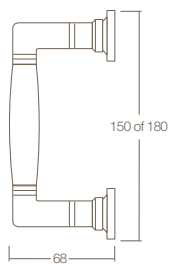

0010.426192	75/150mm
0010.426193	110/180mm



4261

0010.426193

Greep Ton 110/180 mm op vierkant rozet.
Eenzijdige bevestiging.
Messing ongelakt/ebbenhout.

Pull handle Ton 110/180 mm on square rose.
One side fixing. Brass unlacquered/ebony.

Stoßgriff Ton 110/180mm auf Eckige Rosette.
Einseitiger Befestigung.
Messing unlackiert/Ebenholz.

Tirant modèle Ton 110/180 mm avec rosace
carrée. Montage unilatérale.
Laiton non verni/bois d'ébène.

Messing ongelakt - Brass unlacquered

Messing unlackiert - Laiton non verni

Toebehoren - Meubelgrepen

0010

Accessories - Furniture handles

Zubehör - Möbelgriffe

Accessoires - Poignées de meuble

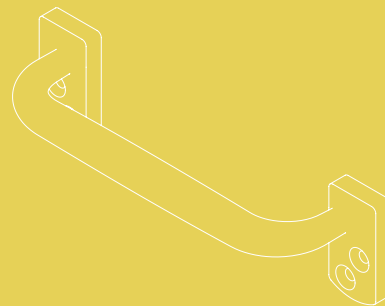

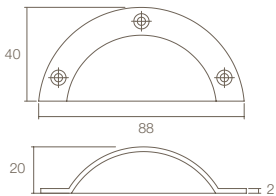
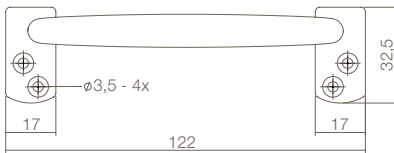
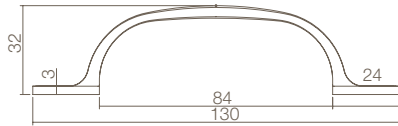
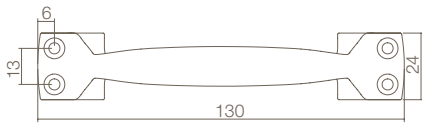

5616

0010.561600 Handgreep op vierkante voet 130mm.
Messing ongelakt.



Furniture handle on square foot 130 mm.
Brass unlacquered.

Handgriff auf Vierkantem Fuß 130 mm.
Messing unlackiert.

Poignee avec une base carree 130mm.
Laiton non verni.



5616

0010.561601 Handgreep Haags model 120mm.
Messing ongelakt.



Furniture handle "Haags" model 120 mm.
Brass unlacquered.

Handgriff Haags-Modell 120 mm.
Messing unlackiert.

Poignee modele La Haye 120mm.
Laiton non verni.



8752

0010.875260 Komgreep opschroevend.
Messing ongelakt.



Grip screw mounting. Brass unlacquered.

Möbelgriff schraubbar. Messing unlackiert.

Poignée Coquille avec trous de vis.
Laiton non verni.

Messing getrommeld - Brass vibrated - Messing Natur - Laiton vieilli

Binnendeurbeslag - Losse krukken

0011

Interior door hardware - Door handles

Innentürbeschläge - Türdrucker

Garnitures de porte intérieure - Béquilles

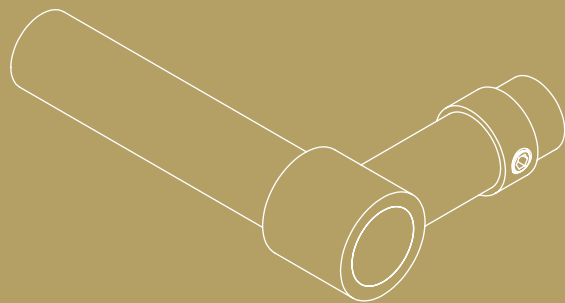

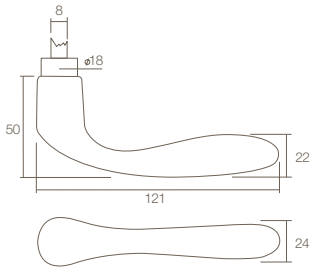

0011.020100

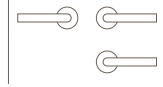

0011.020100A



0201

0011.020100

Deurkruk Banaan. Messing getrommeld.

Door handle Banaan. Brass vibrated.

Türdrücker Banaan. Messing Natur.

Bequille Banane. Laiton vieilli.

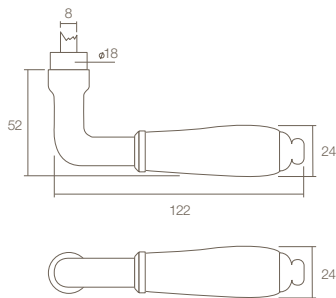

0011.020600

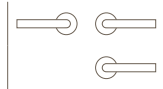

0011.020600A



0206

0011.020600

Deurkruk Courgette.
Messing getrommeld/mat zwart.Door handle courgette.
Brass vibrated/satin black.Türdrücker Courgette.
Messing Natur/matt schwarz.

Bequille Courgette. Laiton vieilli/noir mat.

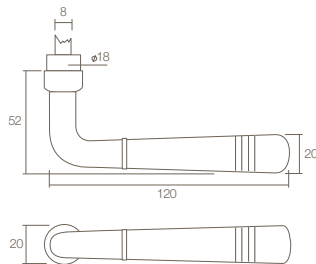

0011.021300

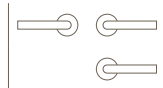

0011.021300A



0213

0011.021300

Deurkruk Monique. Messing getrommeld.

Door handle Monique. Brass vibrated.

Türdrücker Monique.. Messing Natur.

Bequille Monique. Laiton vieilli.

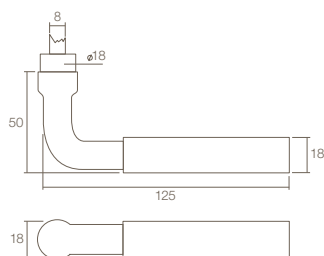

0011.021500

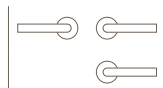

0011.021500A



0215

0011.021500

Deurkruk Palma. Messing getrommeld.

Door handle Palma. Brass vibrated.

Türdrücker Palma. Messing Natur.

Bequille Palma. Laiton vieilli.



Accessoires Accessories Zubehör



0011.317304

0011.317316

0011.317317

0011.317360



0011.322004



0011.370960



0011.258011



0011.256811



0011.257011

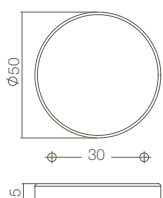

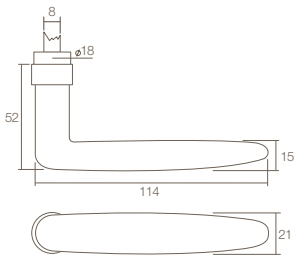

0011.022500

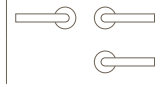

0011.022500A

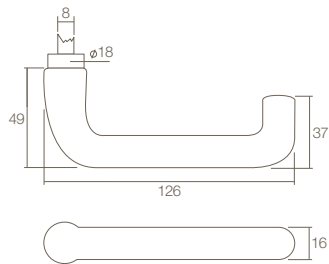

0011.023400

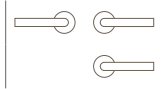

0011.023400A

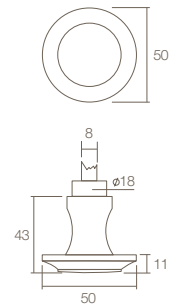

0011.025400

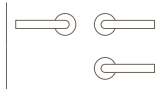

0011.025400A

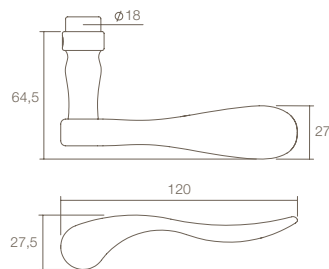

0011.027800

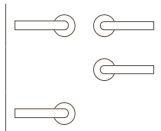

0011.027800A

0011.027800B



0225

0011.022500

Deurkruk Sophie messing getrommeld

Door handle Sophie brass vibrated

Türdrücker Sophie Messing Natur

Béquille Sophie laiton vieilli



0234

0011.023400

Deurkruk Rond. Messing getrommeld.

Door handle round. Brass vibrated.

Türdrücker rund. Messing Natur.

Béquille modèle U. Laiton vieilli.



0254

0011.025400

Knopkruk 50 mm. Messing getrommeld.

Knob handle 50 mm. Brass vibrated.

Knopfdrücker 50 mm. Messing Natur.

Bequille bouton 50mm. Laiton vieilli



0278

0011.027800

Deurkruk Wing messing getrommeld.

Door handle wing brass vibrated.

Türdrücker Wing Messing Natur.

Béquille Wing laiton vieilli.



Accessoires Accessories Zubehör



0011.318604



0011.318616



0011.318617



0011.318660



0011.322004



0011.370960



0011.258011



0011.256811



0011.257011

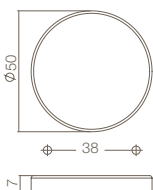

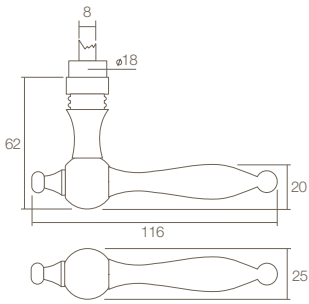

0011.031500

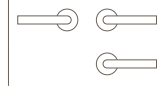

0011.031500A



0315

0011.031500

Deurkruk Peer. Messing getrommeld.

Door handle pear-shaped. Brass vibrated.



Türdrücker Birne. Messing Natur.



Béquille Poire. Laiton vieilli.

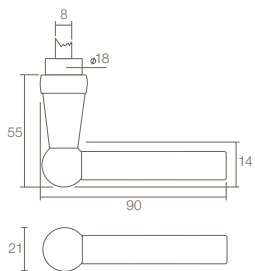

0011.032300

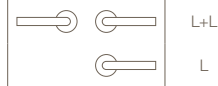

0011.032300A



0323

0011.032300

Deurkruk L/L-model. Messing getrommeld.

Door handle L/L model. Brass vibrated.



Türdrücker L/L-Modell. Messing Natur.



Béquille modèle L/L. Laiton vieilli.

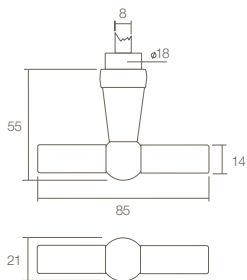

0011.032400

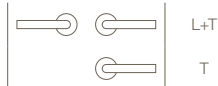

0011.032400A



0324

0011.032400

Deurkruk L/T-model. Messing getrommeld.

Door handle L/T model. Brass vibrated.



Türdrücker L/T-Modell. Messing Natur.



Béquille modèle L/T. Laiton vieilli.

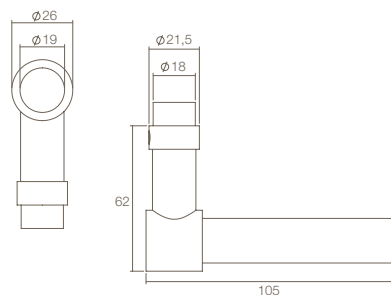

0011.046000

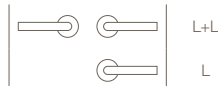

0011.046000A



0460

0011.046000

Deurkruk L/L model. Messing getrommeld.

Door handle L/L. Brass vibrated.



Türdrücker L/L. Messing Natur.



Béquille modèle L/L. Laiton vieilli.

Accessoires
Accessories
Zubehör



0011.318504



0011.318516



0011.318517



0011.318560



0011.322004



0011.370960

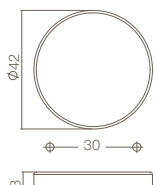

0011.258011



0011.256811



0011.257011

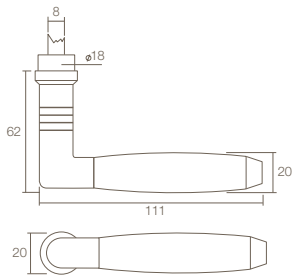

0011.037700

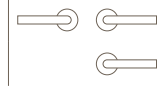

0011.037700A



0377

0011.037700 Deurkruk Ton 400. Messing getrommeld/ebbenhout.



Door handle Ton 400.
Brass vibrated/ebony.



Türdrücker Ton 400.
Messing Natur/Ebenholz.

Béquille Ton 400.
Laiton vieilli/bois d'ébène.

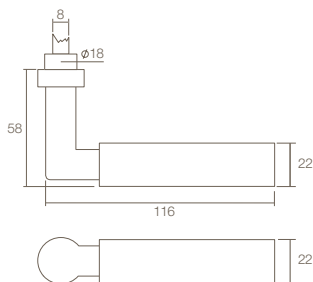

0011.037800

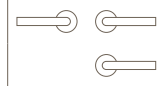

0011.037800A



0378

0011.037800 Deurkruk Bau-stil. Messing getrommeld.



Door handle Baustil. Brass vibrated.



Türdrücker Baustil. Messing Natur.

Béquille Bau-stil. Laiton vieilli.

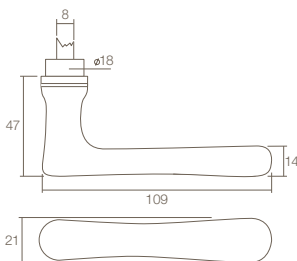

0011.038800

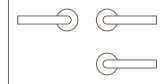

0011.038800A



0388

0011.038800 Deurkruk Trento. Messing getrommeld.



Door handle Trento. Brass vibrated.



Türdrücker Trento. Messing Natur.

Béquille Trento. Laiton vieilli.

Accessoires Accessories Zubehör



0011.318604



0011.318616



0011.318617



0011.318660



0011.322004



0011.370960



0011.258011



0011.256811



0011.257011

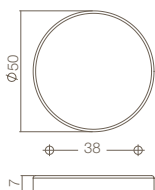

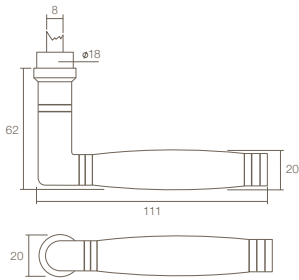

0011.037500

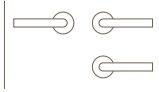

0011.037500A



0375

0011.037500Deurkruk Ton 222. Messing
getrommeld/ebbenhout.Door handle Ton 222.
Brass vibrated/ebony.Türdrücker Ton 222.
Messing Natur/Ebenholz.Béquille Ton 222.
Laiton vieilli/bois d'ébène.

Accessoires

Accessories
Zubehör

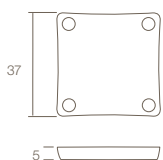

0011.318304



0011.318316



0011.318317



0011.318360

8mm 

0011.322004

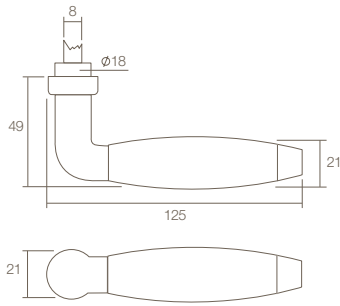

0011.042000

0011.042000A

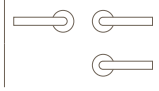

0420

0011.042000Deurkruk Antonnet. Messing
getrommeld/ebbenhout.Door handle Antonnet.
Brass vibrated/ebony.Türdrücker Antonnet.
Messing Natur/Ebenholz.Béquille Antonnet.
Laiton vieilli/bois d'ébène.

Accessoires

Accessories
Zubehör

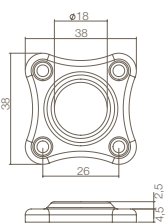

0011.318904



0011.318916



0011.318960



0011.322004



Messing getrommeld - Brass vibrated - Messing Natur - Laiton vieilli

Binnendeurbeslag - Rond / Ovaal

0011









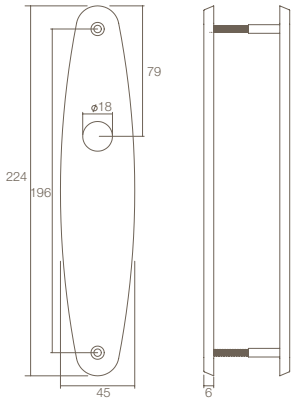











Interior door hardware - Round / Oval

Innentürbeschläge - Rund / Oval

Garnitures de porte intérieure - Ronde / Ovale





0011.258011			-----	
0011.258024				56mm
0011.258026				72mm
0011.258029				55mm
0011.258036				72mm
0011.258065				WC 63/8
0011.258067				WC 72/8

Optie: Te combineren met deurkrukken op pagina 44-49.

Option: Combine with doorhandles from page 44-49.

Option: Zu kombinieren mit Türdrücker auf Seite 44-49.

Option: Une combinaison possible avec les béquilles de la page 44-49.



0280

0011.258011 Schild Ellips blind. Messing getrommeld.



Plate Ellipse blind. Brass vibrated.



Schild Ellipse blind. Messing Natur.

Plaque Ellipse aveugle. Laiton vieilli.

Messing getrommeld - Brass vibrated - Messing Natur - Laiton vieilli

Binnendeurbeslag - Vierkant

0011







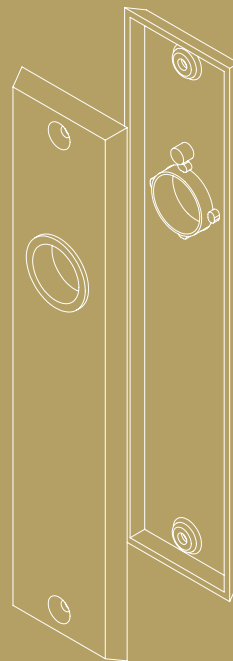

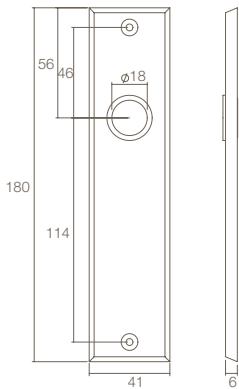

















Interior door hardware - Square

Türbeschläge - Eckig

Garnitures de porte extérieure - Carrée





0011.256811				---	
0011.256824				56mm	
0011.256826				72mm	
0011.256829				55mm	
0011.256836				72mm	
0011.256862				WC 55/8	
0011.256863				WC 57/5	
0011.256865				WC 63/8	
0011.256867				WC 72/8	

Optie: Te combineren met deurkrukken op pagina 44-49.

Option: Combine with doorhandles from page 44-49.

Option: Zu kombinieren mit Türdrücker auf Seite 44-49.

Option: Une combinaison possible avec les béquilles de la page 44-49.



0011.256811

Renovatie kortschild blind.
Messing getrommeld.



Renovation short plate blind.
Brass vibrated.









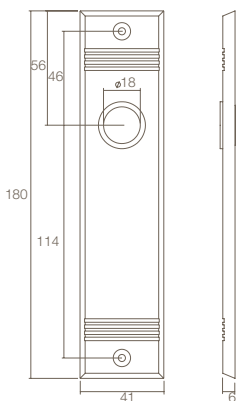

















Renovierungskurtschild blind.
Messing Natur.

Plaque de renovation courte rectangulaire
aveugle. Laiton vieilli.

0256



0011.257011				---	
0011.257024				56mm	
0011.257026				72mm	
0011.257029				55mm	
0011.257036				72mm	
0011.257063				WC 57/5	
0011.257065				WC 63/8	
0011.257067				WC 72/8	

Optie: Te combineren met deurkrukken op pagina 44-49.

Option: Combine with doorhandles from page 44-49.

Option: Zu kombinieren mit Türdrücker auf Seite 44-49.

Option: Une combinaison possible avec les béquilles de la page 44-49.



0011.257011

Kortschild met groef.
Messing getrommeld.



Short plate straight with chamfer.
Brass vibrated.



Kurtschild mit Furche.
Messing Natur.

Plaque courte avec rainures rectangulaire.
Laiton vieilli.

0257









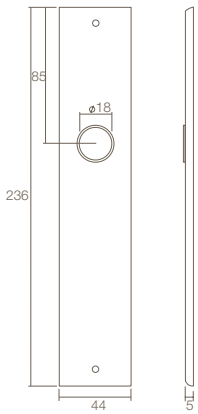



















Accessoires

Accessories
Zubehör



0011.315620



0011.257711			-----	
0011.257724				56mm
0011.257726				72mm
0011.257729				55mm
0011.257736				72mm
0011.257749				92mm
0011.257762				WC 55/8
0011.257763				WC 57/5
0011.257765				WC 63/8
0011.257767				WC 72/8

- Optie:** Te combineren met deurkrukken op pagina 44-49.
- Option:** Combine with doorhandles from page 44-49.
- Option:** Zu kombinieren mit Türdrücker auf Seite 44-49.
- Option:** Une combinaison possible avec les béquilles de la page 44-49.

2577

**0011.257711**

Langschild rechthoekig.
Messing getrommeld.



Long plate straight with chamfer.
Brass vibrated.



Langschild eckig mit Furche.
Messing Natur.

Plaque longue rectangulaire.
Laiton vieilli.

Accessoires

Accessories
Zubehör



0011.315620



Messing getrommeld - Brass vibrated - Messing Natur - Laiton vieilli

Buitendeurbeslag - Rond / Ovaal

0011

Exterior door hardware - Round / Oval

Haustürbeschläge - Rund / Oval

Garnitures de porte extérieure - Ronde / Ovale

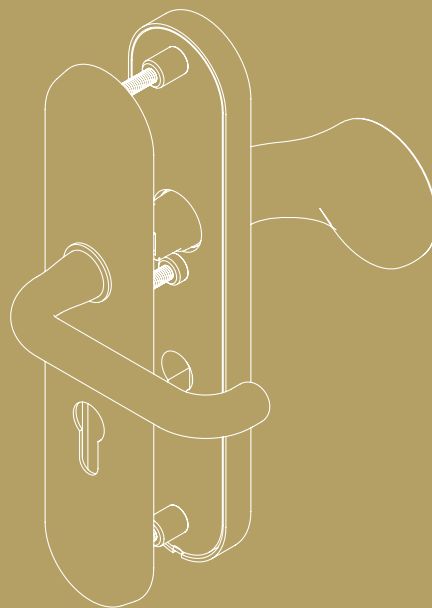

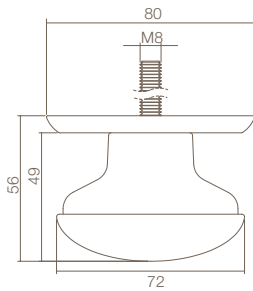
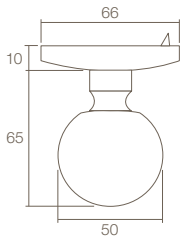

3930

0011.393031 Voordeurknop bolrond vast ø50/66mm.
Doorgaande bevestiging M8.
Messing getrommeld.



Front door knob round ø50/66mm.
Not turnable with bolt. One side fixing M8.
Brass vibrated.

Haustürknoopf kugelrund ø50/66mm
mit einseitiger Befestigung M8.
Messing Natur.

Bouton d'entree fixe petite boule ø50/66mm.
Fixation traversante M8. Laiton vieilli.



3930

0011.393033 Voordeurknop zwaar vast ø72/80mm.
Doorgaande bevestiging M8.
Messing getrommeld.



Front door knob heavy 72/80mm.
Not turnable with bolt. One side fixing M8.
Brass vibrated.

Haustürknoopf schwer ø72/80mm fest
mit einseitiger Befestigung M8.
Messing Natur.

Bouton d'entree fixe grande ø72/80mm.
Fixation traversante M8. Laiton vieilli.

Accessoires

Accessories

Zubehör



0099.997470



Schroefdraad met rvs eindkap t.b.v. bevestiging voordeurknop.
304 RVS geborsteld.

Change spindle for front door knob. including a cover plate.
304 brushed stainless steel.

Gewindestift mit Hutmutter für Haustürknoopf.
Edelstahl 304 gebürstet.

Fixation traversante pour bouton d'entrée.
Inox mat AISI 304.

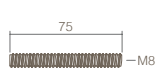

0011.397500

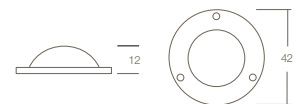

Afdeekplaatje t.b.v. bout. Messing getrommeld.

Bolt cover plate. Brass vibrated.

Abdeckplatte für Bolzen.. Messing Natur.

Ce cache boulon couvre la vis du bouton.
Laiton vieilli.

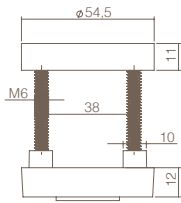
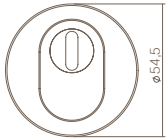

0011.375100

M6



3751

0011.375100

PC veiligheidsrozet rond verdekt met
kerntrekbeveiliging. M6.
Messing getrommeld.



Security euro profile cylinder escutcheon
round with cylinder protection. With invisible
fixing M6. Brass vibrated.

PZ Schutzrosette verdeckt Rund, mit
Kernziehschutz. M6. Messing Natur.

Entrée de cylindre de haute sécurité ronde
avec cache anti-forage. Fixation invisible.
M6. Laiton vieilli.

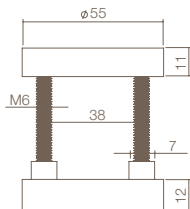
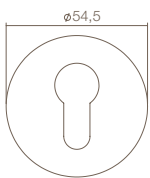

0011.375060

M6



3750

0011.375060

PC veiligheidsrozet rond verdekt. M6.
Messing getrommeld.



Security euro profile cylinder
escutcheon. With invisible fixing. M6.
Brass vibrated.

PZ Schutzrosette verdeckt. M6.
Messing Natur.

Entrée de cylindre de sécurité ronde.
Fixation invisible. M6. Laiton non vieilli.

Accessoires

Accessories
Zubehör



0099.990120	M6	70mm	58 - 64
0099.990122	M6	80mm	68 - 74
0099.990121	M6	90mm	78 - 84

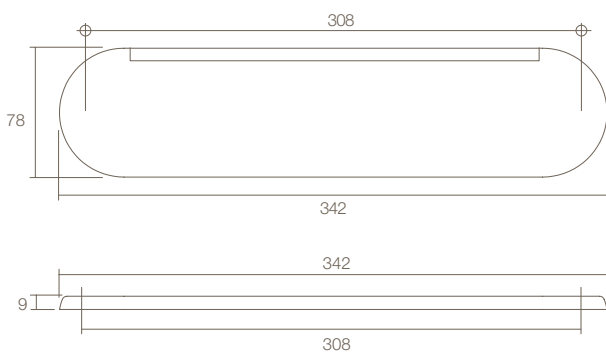
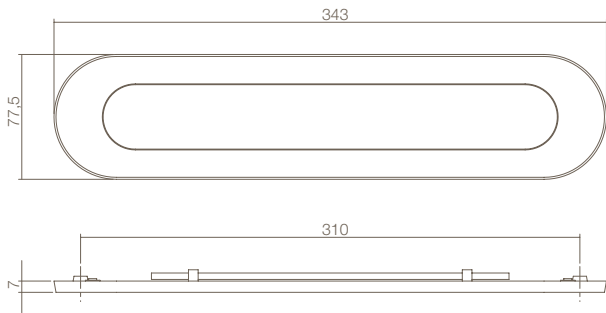

4000



0011.400005

Briefplaat ovaal met veer. Klep half naar binnen draaiend. Zowel horizontaal als verticaal te monteren. Messing getrommeld.



Springloaded oval letter plate. Opens half inwards. Can be mounted both horizontally and vertically. Brass vibrated.

Briefeinwurf oval mit Feder. Klappe halb nach innen öffnend. Kann sowohl horizontal und vertikal montiert werden. Messing Natur.

Plaque-a-lettres ovale avec ressort. Pose horizontal ou vertical. Laiton vieilli.

4015



0011.401500

Tochtwering ovaal met borstel en afdekklep. Messing getrommeld.



Oval draught flap with brush and rain edge. Brass unlacquered.

Zugklappe oval mit Bürstenleise und Abdeckklappe verdeckt. Messing Natur.

Plaque-a-lettres anti courants d'air, ovale, avec clapet. Laiton vieilli.

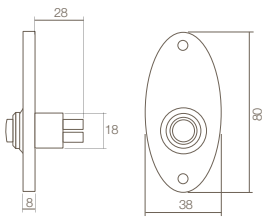
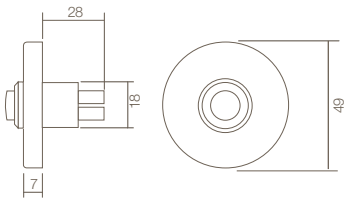

3990

0011.399027

Beldrukker rond verdekt.
Messing getrommeld.



Round concealed bell push.
Brass vibrated.

Klingelplatte rond. Verdeekt. Messing Natur.

Sonnette ronde. Fixation invisible.
Laiton vieilli.



3992

0011.399028

Beldrukker Ellips. Opschroevend.
Messing getrommeld.



Bell push Ellips. Screw mounting.
Brass vibrated.

Klingelplatte Ellipse. Schraubbar.
Messing Natur.

Sonnette Ellipse. Fixation visible.
Laiton vieilli.

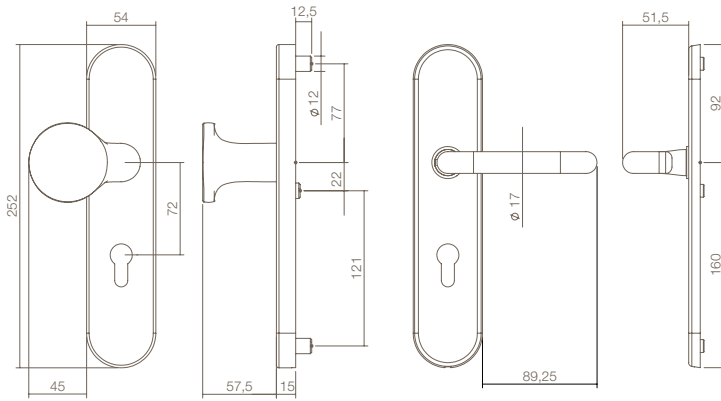

0011.384629		55mm
0011.384636		72mm
0011.384649		92mm



3846

0011.384636

Veiligheidschilden greep/kruk los.
Krukhals \varnothing 18mm. Links of rechts te
monteren. Stift M14 x 8 x 75mm.
Messing getrommeld.



Security plates pull/lever.
Pull is reversible. Insert \varnothing 18mm.
Spindle M14 x 8 x 75mm. Brass vibrated.

Sicherheitsgarnitur Drücker/Griffplatte.
Rechts/links verwendbar. Drücker Hals
 \varnothing 18mm. Stift M14 x 8 x 75mm. Messing Natur.

Garnitures de sécurité. Tirant réversible.
Béquille seule, cou de \varnothing 18mm, droite ou
gauche. Tige M14 x 8 x 75mm. Laiton vieilli.

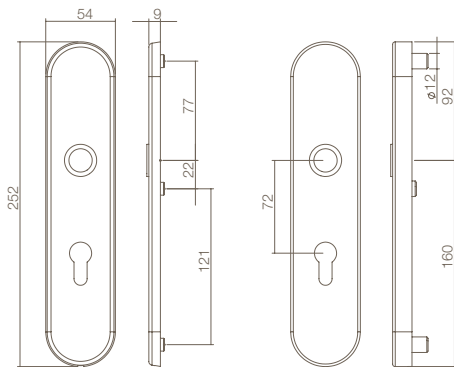

0011.381929		55mm
0011.381936		72mm
0011.381949		92mm

Optie: Te combineren met deurkrukken op
pagina 44-49.

Option: Combine with doorhandles from page
44-49.

Option: Zu kombinieren mit Türdrücker auf
Seite 44-49.

Option: Une combinaison possible avec les
béquilles de la page 44-49.

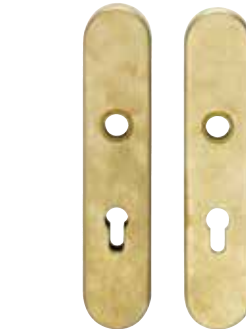

3819

0011.381936

Veiligheidsschilden doorgaand.
Krukhals \varnothing 18mm. Messing getrommeld.



Security plates. Insert \varnothing 18mm.
Brass vibrated.

Schutzbeschlag. Drücker Hals \varnothing 18mm.
Messing natur.

Garnitures de sécurité. Béquille, cou de
 \varnothing 18mm. Laiton vieilli.

Accessoires

Accessories
Zubehör



0011.315620



0099.990120		M6	70mm		58 - 64
0099.990122		M6	80mm		68 - 74
0099.990121		M6	90mm		78 - 84



0099.975343		M14	\square 8x75mm		\leq 42
0099.975363		M14	\square 8x90mm		\leq 60
0099.975364		M14	\square 8x120mm		\leq 90



0099.975000		\square 8x105mm		\leq 42
0099.975001		\square 8x120mm		\leq 58
0099.975002		\square 8x150mm		\leq 90

Messing getrommeld - Brass vibrated - Messing Natur - Laiton vieilli

Buitendeurbeslag - Vierkant

0011

Exterior door hardware - Square

Haustürbeschläge - Eckig

Garnitures de porte extérieure - Carrée

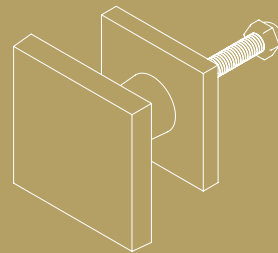

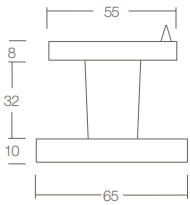

0011.393046

M8



3930

0011.393046

Voordeurknop vierkant vast centraal 65x55mm. Doorgaande bevestiging M8. Messing getrommeld.



Front door knob square central fixed 65/55mm. Bolt through fixing M8. Brass vibrated.



Haustürknopf fest eckig 65/55mm mit durchgehender Befestigung M8. Messing Natur.

Bouton d'entree central fixe carree 65/55mm. Fixation traversante M8. Laiton vieilli.

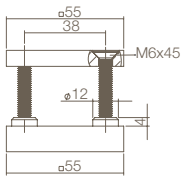

0011.375140

M6



3751

0011.375140

PC veiligheidsrozet massief vierkant. Zichtbare bevestiging M6. Messing getrommeld.



Square euro profile cylinder. With visible fixing. Brass vibrated.



PZ Schtuzrosette eckig. Mit sichtbarer Befestigung. Messing Natur.



Entree de cylindre de securite carree massive. Fixation visible M6. Laiton vieilli.

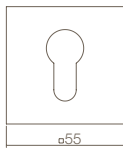

Accessoires

Accessories

Zubehör

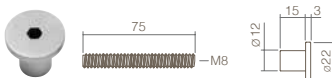

0099.997470

Schroefdraad met rvs eindkap t.b.v. bevestiging voordeurknop. 304 RVS geborsteld.



Change spindle for front door knob. including a cover plate. 304 brushed stainless steel.

Gewindestift mit Hutmutter für Haustürknopf. Edelstahl 304 gebürstet.

Fixation traversante pour bouton d'entrée. Inox mat AISI 304.



0011.397500

Afdeekplaatje t.b.v. bout. Messing getrommeld.



Bolt cover plate. Brass vibrated.

Abdeckplatte für Bolzen.. Messing Natur.

Ce cache boulon couvre la vis du bouton. Laiton vieilli.

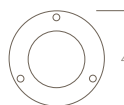

0099.990140



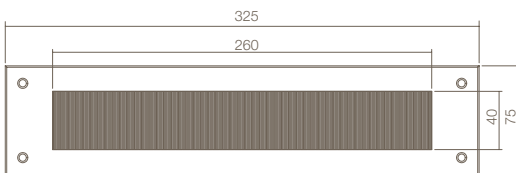
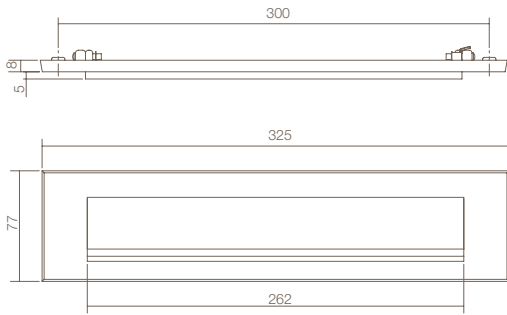

4000



0011.400001 Briefplaat rechthoekig met regenrand.
Klep half naar buitendraaiend.
Messing getrommeld.



Briefeinwurf rechteckig mit Tropfkante.
Klappe halb nach aussen öffnend.
Messing Natur.

Plaque-à-lettres rectangulaire.
S'ouvrant à moitié vers l'extérieur.
Laiton vieilli.

Plaque-à-lettres rectangulaire.
S'ouvrant à moitié vers l'extérieur.
Laiton vieilli.

4015



0011.401503 Tochtwering rechthoekig met borstel.
Messing getrommeld.



Draught flap rectangular with brush.
Brass vibrated.

Zugklappe rechteckig mit Bürstenleiste.
Messing Natur.

Plaque-a-lettres rectangulaire anti courants
d'air avec brosse. Laiton vieilli.

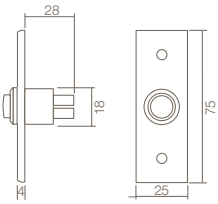
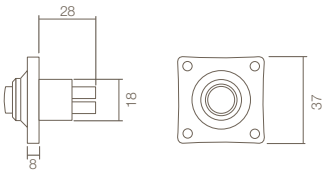

3990

0011.399029

Beldrukker vierkant klein.
Messing getrommeld.



Square bell push. Brass vibrated.
Klingelplatte eckig. Messing Natur.
Sonnette carree petite. Laiton vieilli.



3990

0011.399033

Beldrukker rechthoekig smal.
Messing getrommeld.



Square bell push small. Brass vibrated.
Klingelplatte eckig schmal. Messing Natur.
Sonnette rectangulaire rétrécir. Laiton vieilli.

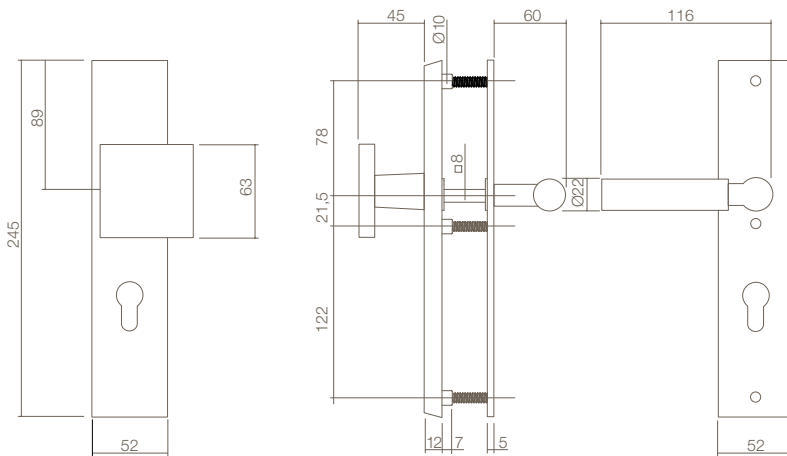

0011.382429		55mm
0011.382436		72mm
0011.382449		92mm

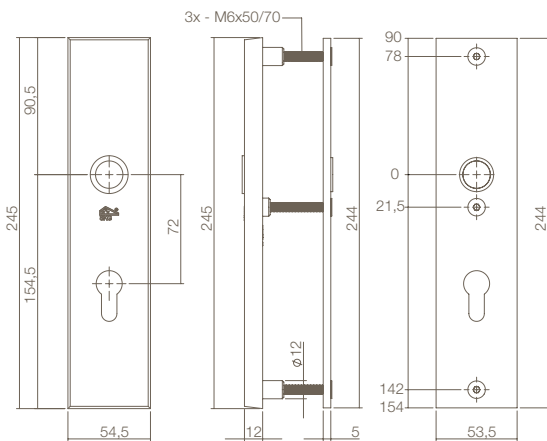

Optie:	Te combineren met deurkrukken op pagina 44-49.	0011.382529		55mm
Option:	Combine with doorhandles from page 44-49.	0011.382536		72mm
Option:	Zu kombinieren mit Türdrücker auf Seite 44-49.	0011.382549		92mm
Option:	Une combinaison possible avec les béquilles de la page 44-49.			

3824

**0011.382436**

PC veiligheidsschilden rechthoekig massief. Greep/kruk los. Krukhals \varnothing 18mm. Links of rechts te monteren. Stift M14 x 8 x 75mm. Messing getrommeld.

Security plates rectangular pull/lever. Pull is reversible. Insert \varnothing 18mm. Spindle M14 x 8 x 75mm. Brass vibrated.

Sicherheitsgarnitur rechteckig Drücker/Griffplatte. Rechts/links verwendbar. Drücker Hals \varnothing 18mm. Stift M14 x 8 x 75mm. Messing Natur.

Garnitures de sécurité rectangulaire. Tirant réversible. Béquille seule, cou de \varnothing 18mm, droite ou gauche. Tige M14 x 8 x 75mm. Laiton vieilli.

3825

**0011.382529**

PC veiligheidsschilden rechthoek massief doorgaand. Krukhals \varnothing 18mm. Messing getrommeld.

Security plates rectangular solid. Insert \varnothing 18mm. Brass vibrated.

Schutzbeschlag rechteckig durchgehend. Drücker Hals \varnothing 18mm. Messing Natur.

Garniture de sécurité rectangulaire massive. Béquille, cou de \varnothing 18mm. Laiton vieilli.

Accessoires

Accessories

Zubehör



0011.315620

0099.990140



M6

90mm

78 - 84



0099.975343

M14

 \square 8x75mm \leq 42

0099.975363

M14

 \square 8x90mm \leq 60

0099.975364

M14

 \square 8x120mm \leq 90

0099.975000

 \square 8x105mm \leq 42

0099.975001

 \square 8x120mm \leq 58

0099.975002

 \square 8x150mm \leq 90



10710

Messing getrommeld - Brass vibrated - Messing Natur - Laiton vieilli

Buitendeurbeslag - Huiscijfers

0011

Exterior door hardware - House numbers

Haustürbeschläge - Hausnummern

Garnitures de portes extérieure - Numéros de maison



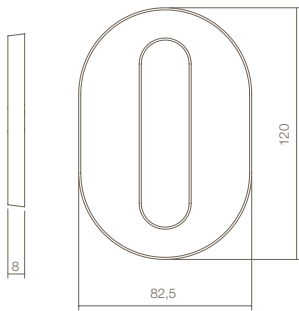

0011.402020	0	120mm
0011.402021	1	120mm
0011.402022	2	120mm
0011.402023	3	120mm
0011.402024	4	120mm
0011.402025	5	120mm
0011.402026	6	120mm
0011.402027	7	120mm
0011.402028	8	120mm
0011.402029	9	120mm



4020

0011.40202x

Huiscijfer. Inclusief bevestiging.
Messing getrommeld.



House number. Including mounting material.
Brass vibrated.

Hausnummer breit. Inkl. Befestigung.
Messing Natur.

Numero de maison. Fixation fournie.
Laiton vieilli.

0 1 2 3 4
5 6 7 8 9

Messing getrommeld - Brass vibrated - Messing Natur - Laiton vieilli

Raambeslag - Raamkrukken en -sluitingen

0011

Window fittings - Window handles and closers

Fensterbeschläge - Fenstersicherung

Garnitures de fenêtre - Béquilles de fenêtre

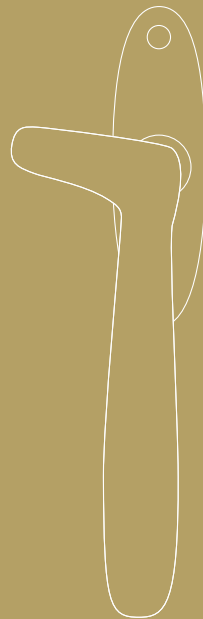

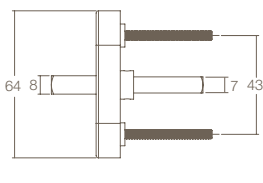
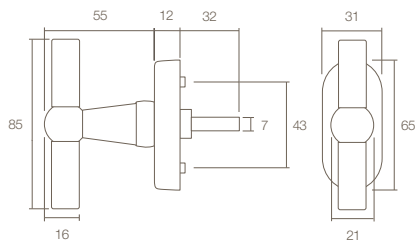
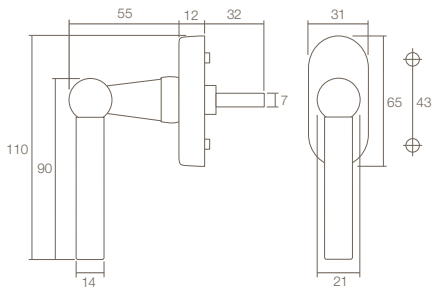

Optie: Te combineren met deurkrukken op pagina 44-49.

Option: Combine with doorhandles from page 44-49.

Option: Zu kombinieren mit Türdrücker auf Seite 44-49.

Option: Une combinaison possible avec les béquilles de la page 44-49.

6050



0011.605011 Raamkruk L-model. Messing getrommeld.



Window handle L-model. Brass vibrated.

Fenstergriff L-model. Messing Natur.

Bequille de fenetre modele L. Laiton vieilli.

6050



0011.605013 Raamkruk T-model. Messing getrommeld.



Window handle T-model. Brass vibrated.

Fenstergriff T-model. Messing Natur.

Bequille de fenetre modele T. Laiton vieilli.

6050



0011.605000 Basisplaat tbv raamkruk met hals $\varnothing 18$ mm. Messing getrommeld.



Baseplate for window handle with a $\varnothing 18$ mm insert. Brass vibrated.

Unterkonstruktion für Fenstergriffe mit $\varnothing 18$ mm Drückerhals. Messing Natur.

Sous-construction pour bequille de fenetre. Cou $\varnothing 18$ mm. Laiton vieilli.

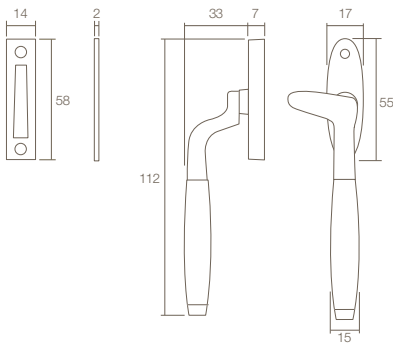

0011.561560A

0011.561560B

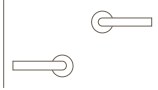

5615

0011.561560A

Raamsluiting.
Messing getrommeld/ebbenhout.Window closer.
Brass vibrated/ebony.Fenstersicherung.
Messing Natur/Ebenholz.

Crémone. Laiton vieilli/bois d'ébène

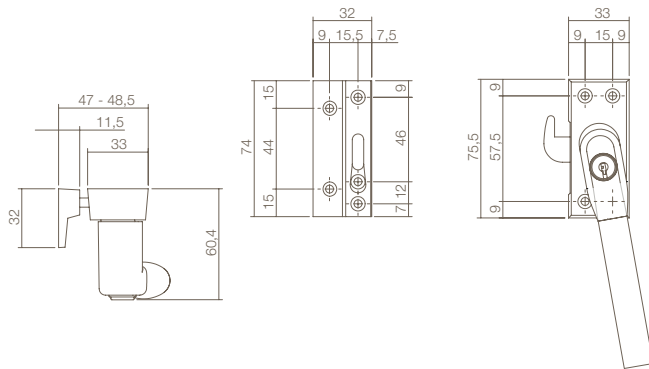

0011.661650A

0011.661650B

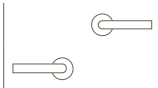

6616

0011.661650A

Afsluitbare raamsluiting compleet.
Messing getrommeld.Lockable window closer straight.
Brass vibrated.Fenstersicherung abschließbar Komplett.
Messing Natur.Béquille de fenêtre en applique verrouillable.
Modèle droite. Complet. Laiton vieilli.

Accessoires

Accessories
Zubehör



0016.661660A

0016.661660B

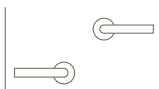

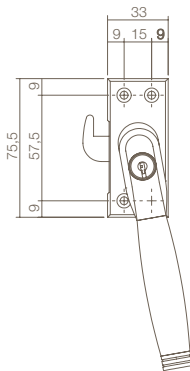
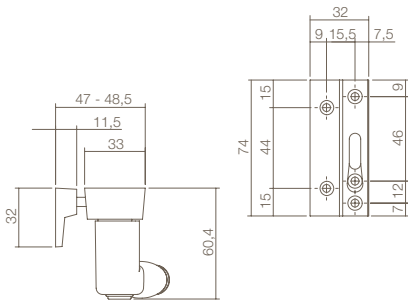

0011.661651A

0011.661651B

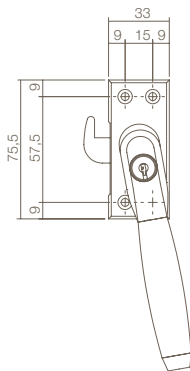
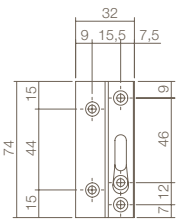
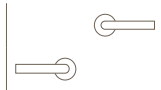

0011.661652A

0011.661652B

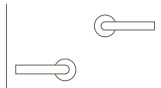

6616

0011.661651A

Afsluitbare raamsluiting Ton 222. compleet.
Messing getrommeld/ebbenhout.



Lockable window closer Ton 222 complete.
Brass vibrated/ebony.



Fenstersicherung abschließbar Ton 22
Komplett. Messing Natur/Ebberholz.



Béquille de fenêtre en applique verrouillable
Ton 222. Modèl droite. Complet.
Laiton vieilli/bois d'ebene.



6616

0011.661652A

Afsluitbare raamsluiting Ton 400.
Messing getrommeld/ebbenhout compleet.



Window closure with lock Ton 400.
Brass vibrated/ebony wood complete.



Abschließbare Fenstergriff Ton 400.
Messing Natur/Ebberholz Komplett.



Béquille de fenêtre en applique verrouillable
Ton 400. Laiton vieilli/bois d'ebene complet.

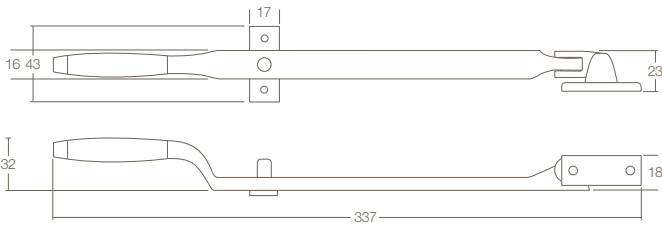
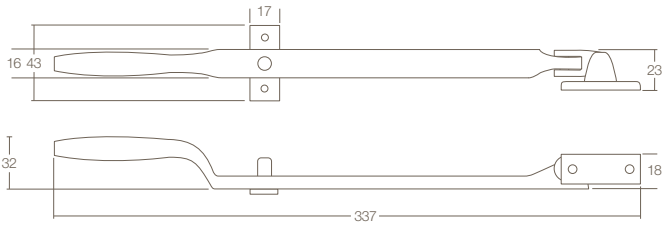

5615



0011.561580

Raamuitzetter Dudok met stelpen.
Messing getrommeld.



Window casement stay. With casement stay
pin. Brass vibrated.

Fensteraufsteller mit Stellstift. Messing Natur.

Entrebailleuse avec cheville de positionnement
Dudok. Laiton vieilli.

5615



0011.561581

Raamuitzetter Dudok met stelpen.
Messing getrommeld/zwart hout.



Window casement stay. With casement stay
pin. Brass vibrated/black wood.

Fensteraufsteller mit Stellstift.
Messing Natur/Swarzes Holz.

Entrebailleuse avec cheville de positionnement.
Laiton verni/bois noir.

Accessoires

Accessories
Zubehör



0011.561589



Messing getrommeld - Brass vibrated - Messing Natur - Laiton vieilli

Toebehoren - Meubelgrepen

0011

Accessories - Furniture handles

Zubehör - Möbelgriffe

Accessoires - Poignées de meuble

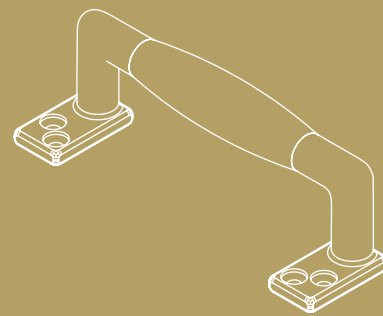

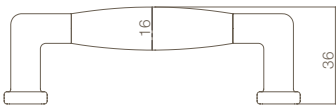
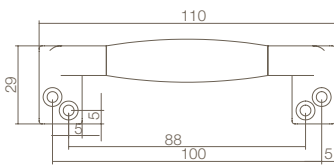
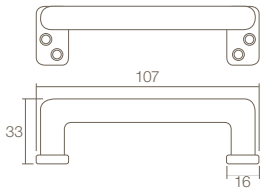

5616

0011.561620 Handgreep recht 107mm.
Messing getrommeld.



Handle straight 107mm. Brass vibrated.
Möbelgriff Recht 107mm. Messing Natur.
Poignée modèle droit 107mm. Laiton vieilli.



5616

0011.561640 Handgreep recht 110mm.
Messing getrommeld/ebbenhout.



Handle straight 110mm.
Brass vibrated/ebony.
Möbelgriff Recht 110mm.
Messing Natur/Ebenholz.
Poignée modele droit 110mm.
Laiton vieilli/bois d'ebene.

Messing gelakt - Brass lacquered - Messing lackiert - Laiton verni

Binnendeurbeslag - Losse krukken

0013

Inside door hardware - Door handles

Innentürbeschläge - Türdrucker

Garnitures de porte intérieure - Bequilles

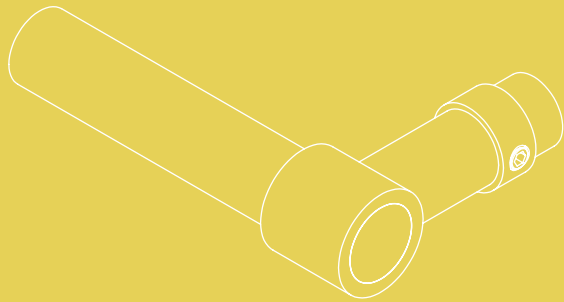

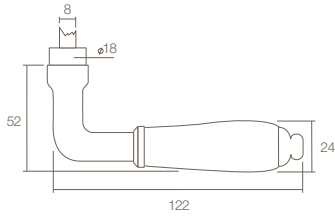

0013.020600
0013.020600A

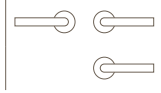

0206

0013.020600 Deurkruk Courgette. Messing gelakt/zwart.



Lever handle Courgette.
Brass lacquered/black.



Türdrücker Courgette.
Messing lackiert/Schwarz.

Bequille Courgette. Laiton verni/noir.

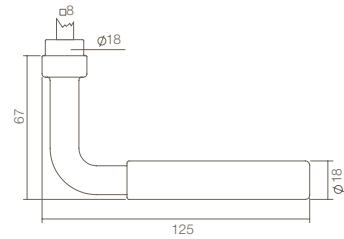

0013.021600
0013.021600A

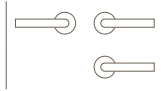

0216

0013.021600 Deurkruk Palma. Messing gelakt/zwart.



Lever handle Palma.
Brass lacquered/black.



Türdrücker Palma.
Messing lackiert/Schwarz.

Bequille Palma. Laiton verni/noir.

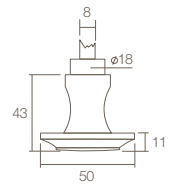

0013.025400
0013.025400A

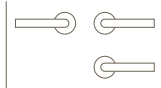

0254

0013.025400 Knopkruk 50mm. Messing gelakt.



Lever handle knob 50 mm. Brass lacquered.



Türdrücker Knopf 50mm. Messing lackiert.

Bequille Bouton 50mm. Laiton verni.

Accessoires
Accessories
Zubehör

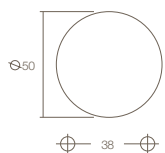

0013.315604



0013.315616



0013.315617



0013.315619



0013.315660



0013.318004



0013.370960



0013.253011

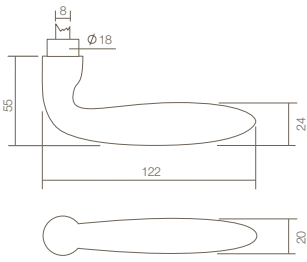

0013.019900
0013.019900A

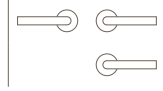

0199

0013.019900 Deurkruk Sigaar. Messing gelakt.
Door handle cigar. Brass lacquered.
Türdrücker Zigarre. Messing lackiert.
Béquille Cigare. Laiton verni.

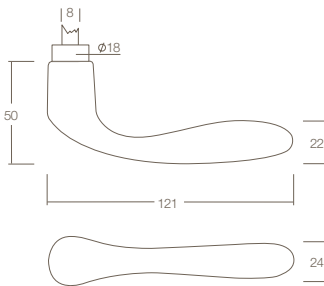

0013.020100
0013.020100A

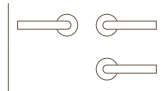

0201

0013.020100 Deurkruk Banaan. Messing gelakt.
Door handle Banaan. Brass lacquered.
Türdrücker Banaan. Messing lackiert.
Béquille Banane. Laiton verni.

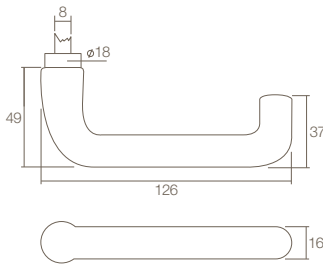

0013.023400
0013.023400A

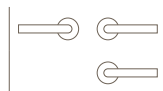

0234

0013.023400 Deurkruk Rond. Messing gelakt.
Door handle round. Brass lacquered.
Türdrücker rund. Messing lackiert.
Béquille modèle U. Laiton verni.



Accessoires
Accessories
Zubehör

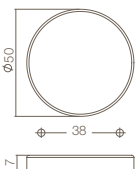

0013.318604



0013.318616



0013.318617



0013.318657
0013.318660

5mm
8mm



0013.370557
0013.370558
0013.370560
0013.370660

5mm
6mm
8mm
8mm verlengd



0013.253011

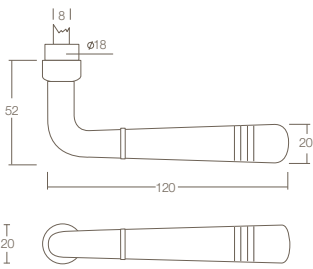

0013.021300
0013.021300A

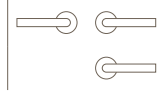

0213

0013.021300 Deurkruk Monique. Messing gelakt.
Door handle Monique. Brass lacquered.
Türdrücker Monique. Messing lackiert.
Béquille Monique. Laiton verni.

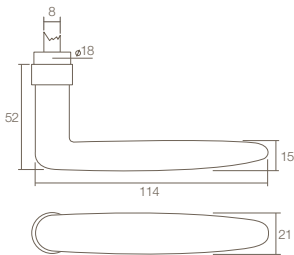

0013.022500
0013.022500A

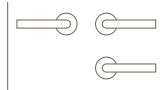

0225

0013.022500 Deurkruk Sophie. Messing gelakt.
Door handle Sophie. Brass lacquered.
Türdrücker Sophie. Messing lackiert.
Béquille Sophie. Laiton verni.

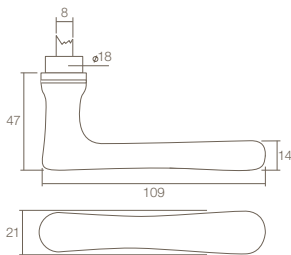

0013.038800
0013.038800A

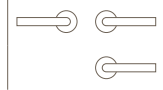

0388

0013.038800 Deurkruk Trento. Messing gelakt.
Door handle Trento. Brass lacquered.
Türdrücker Trento. Messing lackiert.
Béquille Trento. Laiton verni.



Accessoires
Accessories
Zubehör

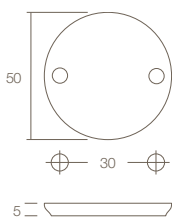

0013.317304



0013.317316



0013.317317



0013.317360

8mm



0013.370557
0013.370558
0013.370560
0013.370660

5mm
6mm
8mm
8mm verlengd



0013.322004



0013.253011

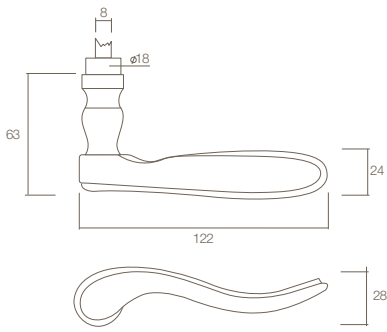

- 0013.027700
- 0013.027700A
- 0013.027700B

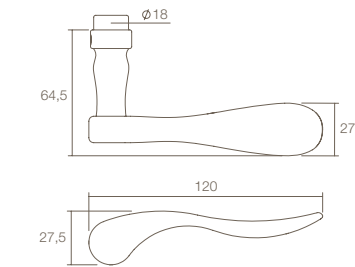

- 0013.027800
- 0013.027800A
- 0013.027800B

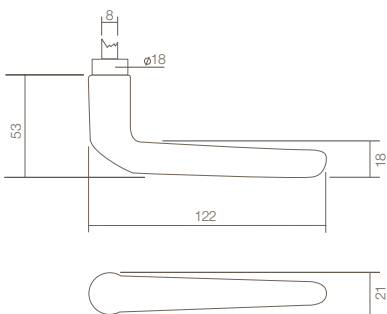

- 0013.021100
- 0013.021100A



0277

- 0013.027700** Deurkruk Wing met rand. Messing gelakt.
 Door handle wing with side. Brass lacquered.
 Türdrücker Flügel mit Rand. Messing lackiert.
 Béquille Wing avec bord. Laiton verni.



0278

- 0013.027800** Deurkruk Wing. Messing gelakt.
 Door handle wing. Brass lacquered.
 Türdrücker Flügel. Messing lackiert.
 Béquille Wing. Laiton verni.



0278

- 0013.021100** Deurkruk Duim. Messing gelakt.
 Door handle Duim. Brass lacquered.
 Türdrücker Duim. Messing lackiert.
 Béquille Duim. Laiton verni.



Accessoires
 Accessories
 Zubehör

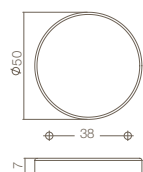

0013.318604



0013.318616



0013.318617



- 0013.318657 5mm
- 0013.318660 8mm



- 0013.370557 5mm
- 0013.370558 6mm
- 0013.370560 8mm
- 0013.370660 8mm verlengd



0013.253011

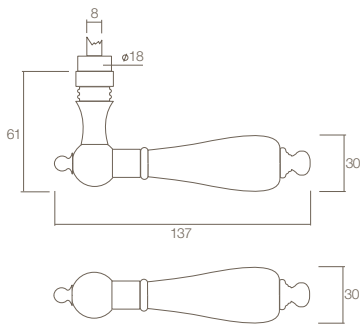

0013.031800

0013.031800A

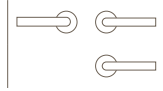

0318

0013.031800

Deurkruk Peer zwaar.
Messing gelakt/porselein.



Door handle pear-shaped heavy.
Brass lacquered/porcelain.



Türdrücker Birne schwer.
Messing lackiert/Porzellan.

Béquille Poire massive.
Laiton verni/porcelaine.

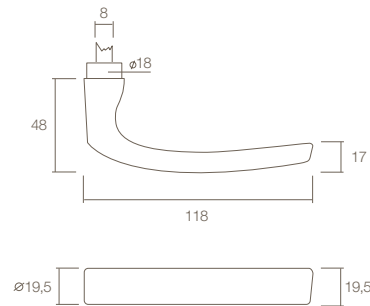

0013.036800

0013.036800A

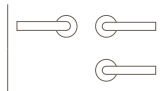

0368

0013.036800

Deurkruk Blok. Messing gelakt.



Lever handle Bloack. Brass lacquered.



Türdrücker Block. Messing lackiert.

Béquille Blok. Laiton verni.

Accessoires Accessories Zubehör

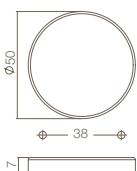

0013.318604



0013.318616



0013.318617



0013.318657
0013.318660

5mm ⌀
8mm ⌀



0013.370557
0013.370558
0013.370560
0013.370660

5mm ⌀
6mm ⌀
8mm ⌀
8mm ⌀ verlengd



0013.253011

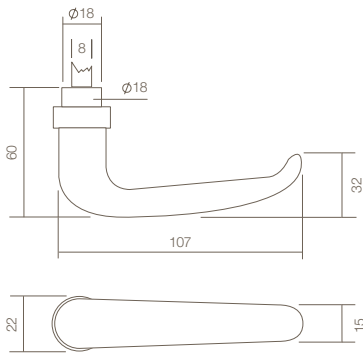

0013.024300

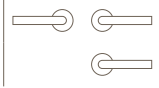

0013.024300A



0243

0013.024300

Deurkruk Sabel. Messing gelakt.



Door handle Sabre. Brass lacquered.



Türdrücker Säbel. Messing lackiert.

Béquille Sabel. Laiton verni.

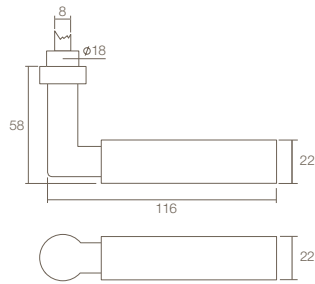

0013.037800

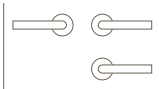

0013.037800A



0378

0013.037800

Deurkruk Bau-stil. Messing gelakt.



Door handle Baustil. Brass lacquered.



Türdrücker Baustil. Messing lackiert.

Béquille Bau-stil. Laiton verni.

Accessoires
Accessories
Zubehör

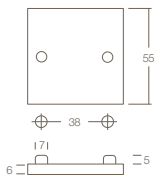

0013.318404



0013.318416



0013.318417



0013.318460



0013.318617



0013.318604



0013.318616



0013.318660



0013.318660



8mm



0013.605090



0013.322004



0013.370860



0013.370960



0013.370560

0013.370660

8mm

8mm verlengd

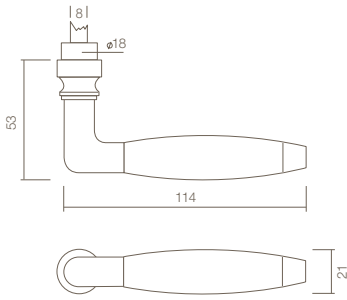

0013.037100
0013.037100A

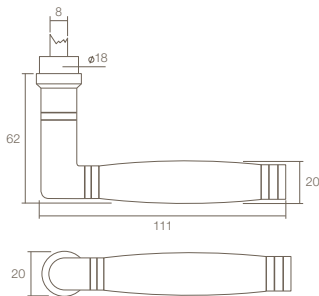

0013.037500
0013.037500A

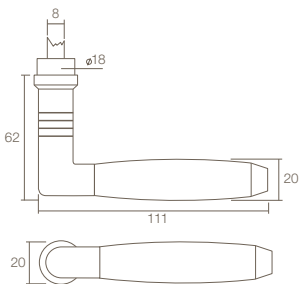

0013.037700
0013.037700A



0371

0013.037100 Deurkruk Marloes.
Messing gelakt/ebbenhout.



Door handle Marloes.
Brass lacquered/ebony.



Türdrücker Marloes.
Messing lackiert/Ebenholz.

Béquille Marloes.
Laiton verni/bois d'ébène.



0375

0013.037500 Deurkruk Ton 222.
Messing gelakt/ebbenhout.



Door handle Ton 222.
Brass lacquered/ebony.



Türdrücker Ton 222.
Messing lackiert/Ebenholz.

Béquille Ton 222.
Laiton verni/bois d'ébène.



0377

0013.037700 Deurkruk Ton 400.
Messing gelakt/ebbenhout.



Door handle Ton 400.
Brass lacquered/ebony.



Türdrücker Ton 400.
Messing lackiert/Ebenholz.

Béquille Ton 400.
Laiton verni/bois d'ébène.

Accessoires
Accessories
Zubehör

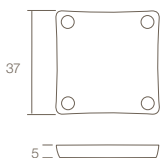

0013.318304



0013.318316



0013.318317



0013.318360 8mm



0013.322004



0099.370000



0013.370001



0013.371059

0013.371060

7mm
8mm



0013.253011

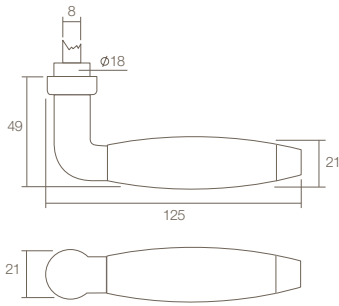

0013.042000

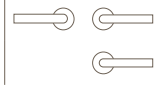

0013.042000A



0420

0013.042000

Deurkruk Antonnet.
Messing gelakt/ebbenhout.



Door handle Antonnet.
Brass lacquered/ebony.



Türdrücker Antonnet.
Messing lackiert/Ebenholz.

Béquille Antonnet.
Laiton verni/bois d'ébène.

Accessoires
Accessories
Zubehör

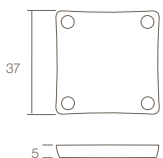

0013.318304



0013.318316



0013.318317



0013.318360



8mm ⌀



0013.318904



0013.318916



0013.318960



8mm ⌀



0013.370960

8mm ⌀



0013.370001



0013.370002



0013.370101

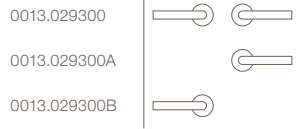
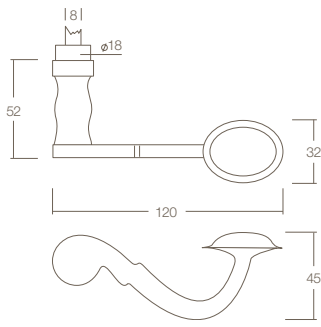

0293



0013.029300 Deurkruk Posthoorn. Messing gelakt.
 Door handle post horn. Brass lacquered.
 10
 Türdrücker Posthorn. Messing lackiert.
 Béquille Cor Postal. Laiton verni.

Accessoires
 Accessories
 Zubehör

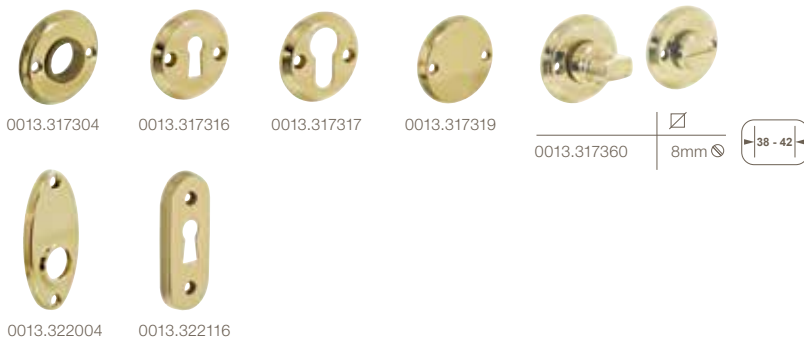
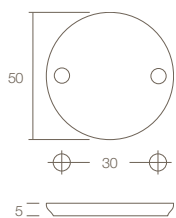

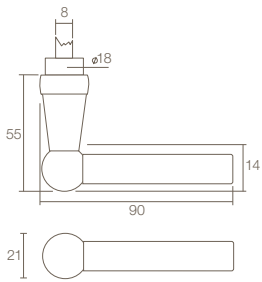

0013.032300		L+L
0013.032300A		L



0323

0013.032300 Deurkruk L/L-model. Messing gelakt.
 Door handle L/L model. Brass lacquered.
 Türrücker L/L-Modell. Messing lackiert.
 Béquille modèle L/L. Laiton verni.

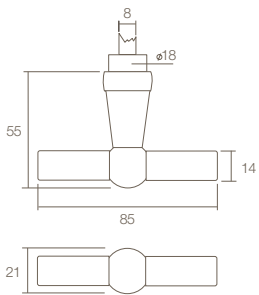

0013.032400		L+T
0013.032400A		T



0324

0013.032400 Deurkruk L/T-model. Messing gelakt.
 Door handle L/T model. Brass lacquered.
 Türrücker L/T-Modell. Messing lackiert.
 Béquille modèle L/T. Laiton verni.

Accessoires
 Accessories
 Zubehör



0013.318504



0013.318516



0013.318517

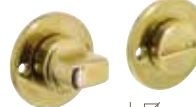

0013.318560 | 8mm



0013.370860

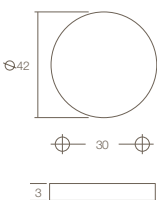

0013.371059 | 7mm
 0013.371060 | 8mm



0013.370960 | 8mm



0013.370560 | 8mm
 0013.370660 | 8mm verlengd





Messing gelakt - Brass lacquered - Messing lackiert - Laiton verni

Binnendeurbeslag - Rond / Ovaal

0013

Interior door hardware - Round / Oval

Innentürbeschläge - Rund / Oval

Garnitures de porte intérieure - Ronde / Ovale

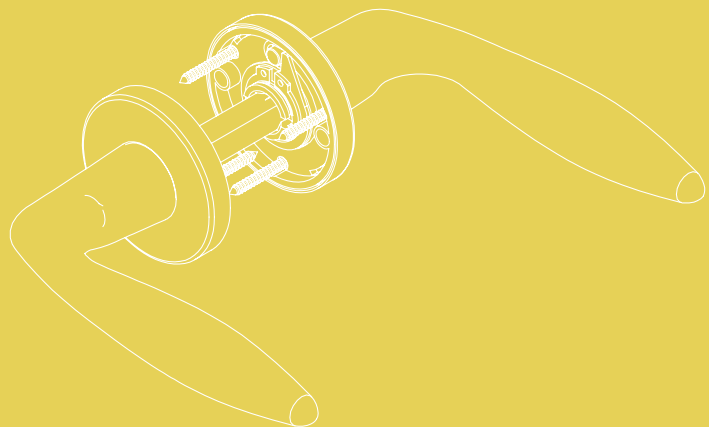

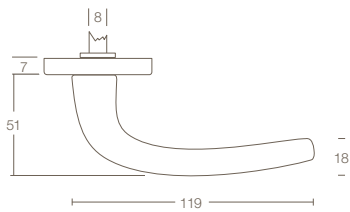

0013.019402

0013.019402A

0013.019402B

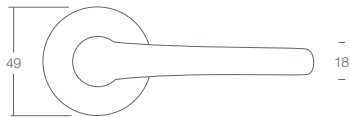
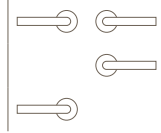

0013.019502

0013.019502A

0013.019502B

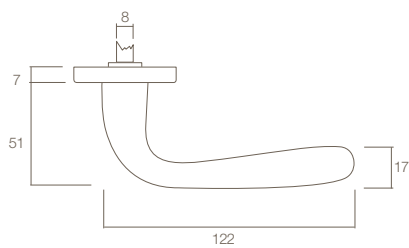
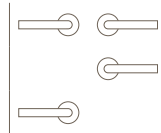

0013.019902

0013.019902A

0013.019902B

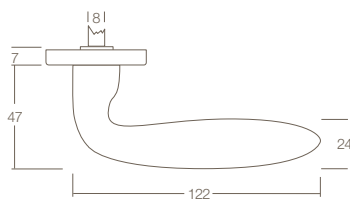
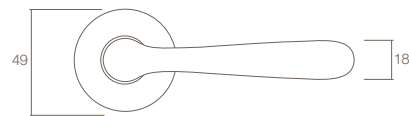
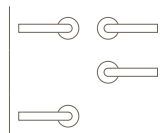

0013.371059

0013.371060

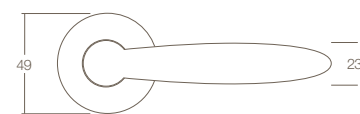

0194

0013.019402

Deurkruk Cosmos vastdraaibaar met veer op ronde rozet. Messing gelakt.



Springloaded lever handle Cosmos on round rose. Brass lacquered.



Türdrücker Cosmos festdrehbar gelagert mit Feder auf runder Rosette. Messing lackiert.



Bequille Cosmos sertie sur rosace ronde avec ressort. Laiton verni.



0195

0013.019502

Deurkruk Jupiter vastdraaibaar met veer op ronde rozet. Messing gelakt.



Springloaded lever handle Jupiter on round rose. Brass lacquered.



Türdrücker Jupiter festdrehbar gelagert mit Feder auf runder Rosette. Messing lackiert.



Bequille Jupiter sertie sur rosace ronde avec ressort. Laiton verni.



0199

0013.019902

Deurkruk Sigara vastdraaibaar met veer op ronde rozet. Messing gelakt.



Springloaded lever handle Cigar on round rose. Brass lacquered.



Türdrücker Zigarre festdrehbar gelagert mit Feder auf runder Rosette. Messing lackiert.



Bequille Cigare sertie sur rosace ronde avec ressort. Laiton verni.

Accessoires Accessories Zubehör

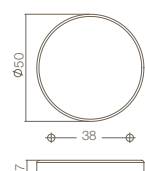

0013.318604



0013.318616



0013.318617



0013.318660



8mm



0013.370860

0013.371059
0013.3710607mm
8mm

0013.370960



8mm

0013.370560
0013.3706608mm
8mm verlengd

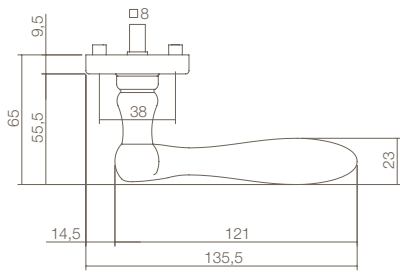

0013.028702

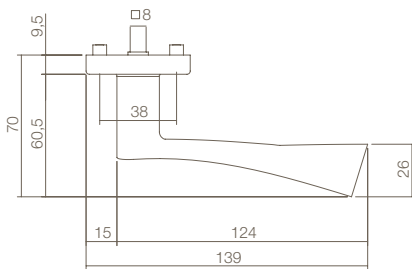

0013.028202

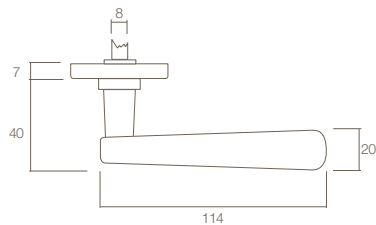

0013.028402



0013.028402A



0013.028402B



0287

0013.028702

Deurkruk Lepel/duim vastdraaibaar met veer op ronde rozet. Messing gelakt.



Door handle spoon/Duim on rose brass lacquered.



Türgriff Löffel/Duim auf Rosette Messing lackiert.



Béquille Lepel/duim sertie sur rosace ronde avec ressort laiton verni.



0231

0013.028202

Deurkruk Vlinder vastdraaibaar met veer op ronde rozet. Messing gelakt.



Door handle Vlinder on rose. Brass lacquered.



Türdrücker Vlinder auf Rosette. Messing lackiert.



Béquille Vlinder sertie sur rosace ronde avec ressort. Laiton verni.



0284

0013.028402

Deurkruk Mare vastdraaibaar met veer op ronde rozet. Messing gelakt.



Door handle Mare on rose. Brass lacquered.



Türdrücker Mare auf Rosette. Messing lackiert.



Béquille Mare sertie sur rosace ronde avec ressort. Laiton verni.

Accessoires Accessories Zubehör

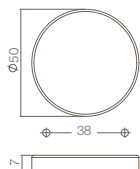

0013.318616



0013.318617



0013.318660



8mm



0013.370860



0013.371059 7mm
0013.371060 8mm

0013.370960 8mm

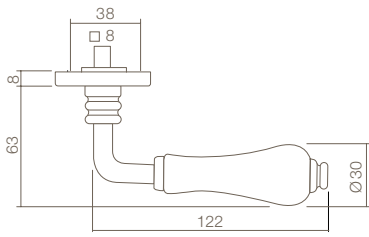
0013.370560 8mm
0013.370660 8mm verlengd



0013.022902

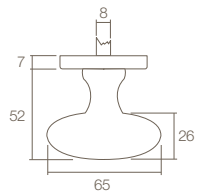
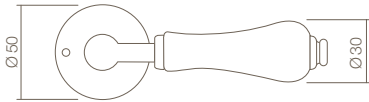

0013.025902



0013.025902A

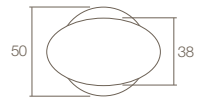

0229

0013.022902

Deurkruk Dalia vastraabaar op rozet.
Messing gelakt/porselein.



Door handle Dalia on rose.
Brass lacquered/porcelain.



Türdrücker Dalia auf Rosette.
Messing lackiert/Porzellan.



Béquille Dalia sertie sur rosace ronde.
Laiton verni/porcelaine.



0259

0013.025902

Knopkruk ovaal op rozet. Messing gelakt.



Knob handle oval on rose. Brass lacquered.



Knopfdrücker oval auf Rosette.
Messing lackiert.



Béquille Bouton ovale sertie sur rosace
ronde. Laiton verni.

Accessoires

Accessories
Zubehör



0013.317316



0013.317317



0013.317319







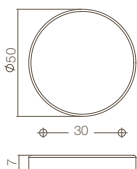

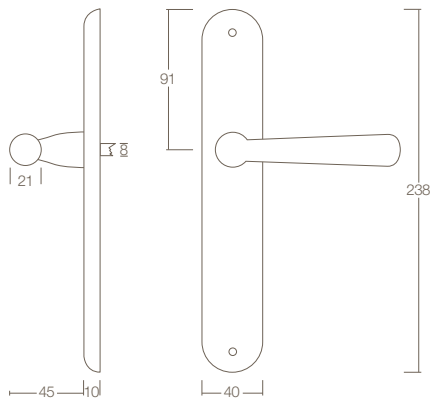







0013.317360

8mm





0013.019711			-----	
0013.019724				56mm
0013.019729				55mm
0013.019736				72mm
0013.019765				WC 63/8



0197

0013.019711

Deurkruk Yvonne vastdraaibaar met veer op langschild. Messing gelakt.



Lever handle Yvonne on long plate. Brass lacquered.









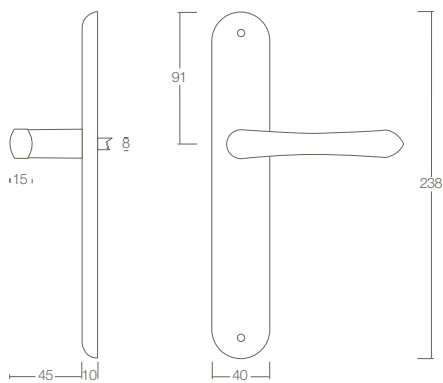











Türdrücker Yvonne auf Langschild. Messing lackiert.



Bequille Yvonne sertie sur plaque lonque avec ressort. Laiton verni.



0013.019811			-----	
0013.019811A			-----	
0013.019811B			-----	
0013.019824				56mm
0013.019829				55mm
0013.019836				72mm
0013.019863				WC 57/5
0013.019865				WC 63/8



0198

0013.019811

Deurkruk Saturnus vastdraaibaar met veer op langschild. Messing gelakt.



Lever handle Saturnus on long plate. Brass lacquered.



Türdrücker Saturnus auf Langschild. Messing lackiert.



Bequille Saturnus sertie sur plaque lonque avec ressort. Laiton verni.



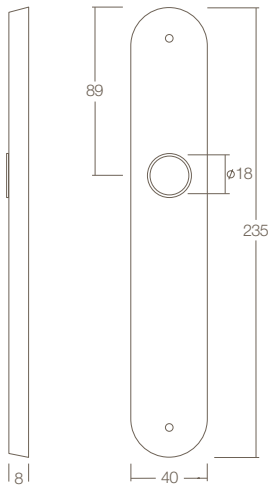

0013.253015			★	
0013.253011			---	
0013.253024				56mm
0013.253026				72mm
0013.253029				55mm
0013.253036				72mm
0013.253063				WC 57/5
0013.253065				WC 63/8
0013.253067				WC 72/8

- Optie:** Te combineren met deurkrukken op pagina 80-89.
- Option:** Combine with doorhandles from page 80-89.
- Option:** Zu kombinieren mit Türdrücker auf Seite 80-89.
- Option:** Une combinaison possible avec les béquilles de la page 80-89.



2530

- 0013.253011** Langschild ovaal . Messing gelakt.
 Long plate oval. Brass lacquered.
 Langschild oval. Messing lackiert.
 Plaque longue ovale. Laiton verni.

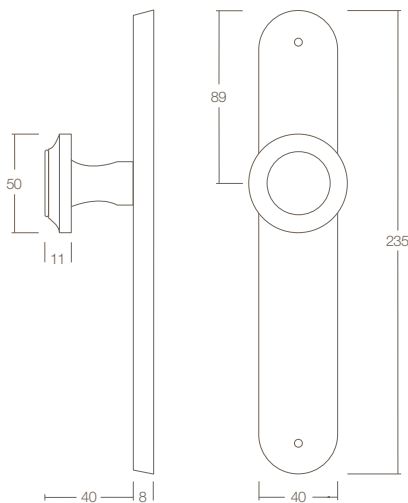

0013.253511			---	
0013.253524				56mm
0013.253526				72mm
0013.253529				55mm
0013.253536				72mm

- Optie:** Te combineren met deurkrukken op pagina 80-89.
- Option:** Combine with doorhandles from page 80-89.
- Option:** Zu kombinieren mit Türdrücker auf Seite 80-89.
- Option:** Une combinaison possible avec les béquilles de la page 80-89.



2535

- 0013.253511** Knop op langschild ovaal. Messing gelakt.
 Knob on long plate. Brass lacquered.
 Knopf Langschild. Messing lackiert.
 Bouton fixe sur plaque longue ovale.
 Laiton verni.



Accessoires

Accessories

Zubehör









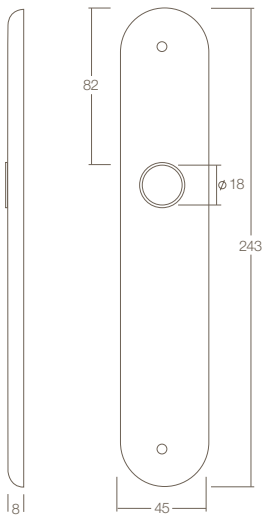













0013.315620



0099.975343	M14		□ 8x75mm	≤ 42
0099.975363	M14		□ 8x90mm	≤ 60
0099.975364	M14		□ 8x120mm	≤ 90



0013.253811			-----	
0013.253824				56mm
0013.253826				72mm
0013.253829				55mm
0013.253836				72mm
0013.253865				WC 63/8
0013.253867				WC 72/8

Optie: Te combineren met deurkrukken op pagina 80-89.

Option: Combine with doorhandles from page 80-89.

Option: Zu kombinieren mit Türdrücker auf Seite 80-89.

Option: Une combinaison possible avec les béquilles de la page 80-89.



0013.253811 Langschild breed ovaal. Messing gelakt.

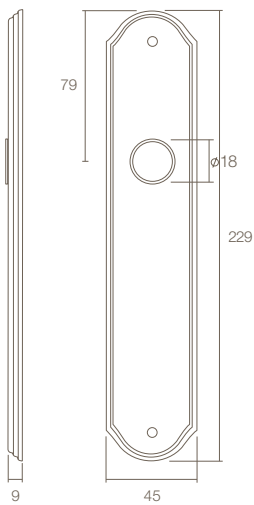



























Plate wide oval. Brass lacquered.

Schild breit oval. Messing lackiert.

Plaque large arrondie. Laiton verni.

2538



0013.254911			-----	
0013.254924				56mm
0013.254926				72mm
0013.254928				110mm
0013.254929				55mm
0013.254936				72mm
0013.254965				WC 63/8
0013.254967				WC 72/8
0013.254969				WC 78/8

Optie: Te combineren met deurkrukken op pagina 80-89.

Option: Combine with doorhandles from page 80-89.

Option: Zu kombinieren mit Türdrücker auf Seite 80-89.

Option: Une combinaison possible avec les béquilles de la page 80-89.



0013.254911 Langschild 075. Messing gelakt.



Long plate 075. Brass lacquered.

Langschild 075. Messing lackiert.

Plaque longue, modèle 075. Laiton verni.

2549

Accessoires

Accessories
Zubehör



0013.315620





Messing gelakt - Brass lacquered - Messing lackiert - Laiton verni

Binnendeurbeslag - Vierkant

0013

Interior door hardware - Square

Innentürbeschläge - Eckig

Garnitures de porte intérieure - Carrée



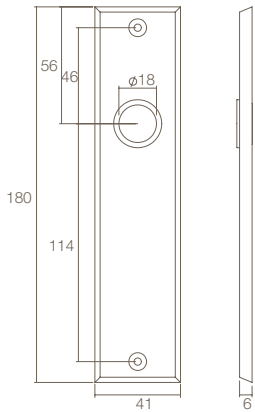

0013.256811				---	
0013.256824				56mm	
0013.256826				72mm	
0013.256829				55mm	
0013.256836				72mm	
0013.256863				WC 57/5	
0013.256865				WC 63/8	
0013.256867				WC 72/8	

Optie: Te combineren met deurkrukken op pagina 80-89.

Option: Combine with doorhandles from page 80-89.

Option: Zu kombinieren mit Türdrücker auf Seite 80-89.

Option: Une combinaison possible avec les béquilles de la page 80-89.



0256

0013.256811 Kortschild rechthoekig. Messing gelakt.



Short plate straight. Brass lacquered.



Kurtschild eckig. Messing lackiert.

Plaque courte rectangulaire. Laiton verni.

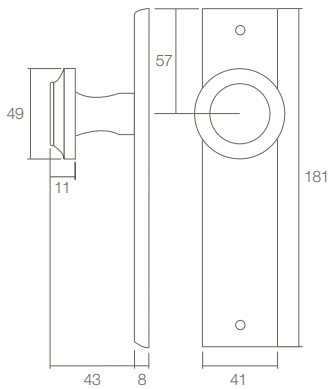

0013.256911				---	
0013.256924				56mm	
0013.256926				72mm	
0013.256929				55mm	
0013.256936				72mm	



0256

0013.256911 Knop op kortschild rechthoekig. Messing gelakt.



Knob on long plate straight. Brass lacquered.



Knopf Kurzschild eckig. Messing lackiert.

Plaque courte rectangulaire avec bouton fixe. Laiton verni.

Accessoires

Accessories
Zubehör









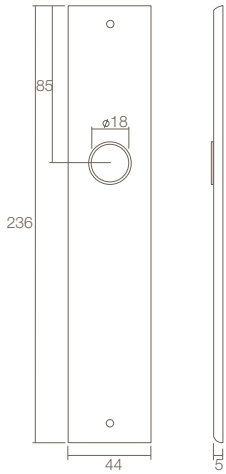



















0013.315620



0099.975343	M14		□ 8x75mm	≤ 42
0099.975363	M14		□ 8x90mm	≤ 60
0099.975364	M14		□ 8x120mm	≤ 90



0013.257711			-----	
0013.257724				56mm
0013.257726				72mm
0013.257729				55mm
0013.257736				72mm
0013.257742				85mm
0013.257749				92mm
0013.257765				WC 63/8
0013.257767				WC 72/8

Optie: Te combineren met deurrukken op pagina 80-89.

Option: Combine with doorhandles from page 80-89.

Option: Zu kombinieren mit Türdrücker auf Seite 80-89.

Option: Une combinaison possible avec les béquilles de la page 80-89.



0013.257711 Langschild rechthoekig. Messing gelakt.



Long plate straight. Brass lacquered.



Langschild eckig. Messing lackiert.

Plaque de renovation longue rectangulaire. Laiton verni.

Accessoires

Accessories
Zubehör



0013.315620



Messing gelakt - Brass lacquered - Messing lackiert - Laiton verni

Buitendeurbeslag - Rond / Ovaal

0013

Exterior door hardware - Round / Oval

Haustürbeschläge - Rund / Oval

Garnitures de porte extérieure - Ronde / Ovale

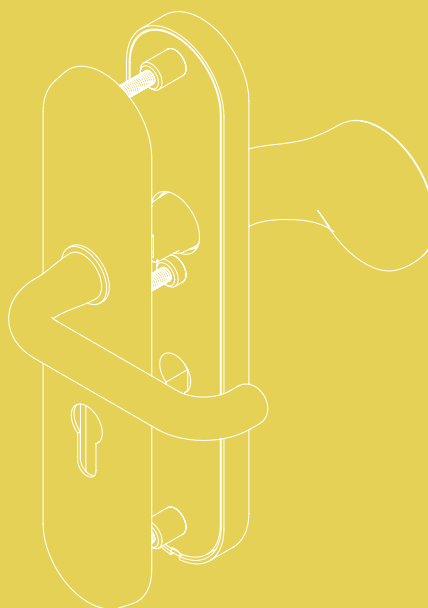

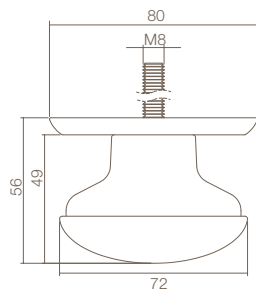
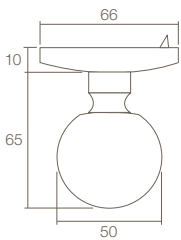
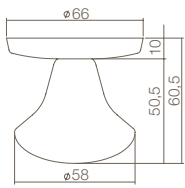

3930

0013.393030 Voordeurknop Paddenstoel vast ϕ 58/66mm. Doorgaande bevestiging M8. Messing gelakt.



Front door knob mushroom ϕ 58/66mm not turnable with bolt one side fixing M8. Brass lacquered.

Haustürknoopf Pilz ϕ 58/66mm fest mit einseitiger Befestigung M8. Messing lackiert.

Bouton d'entree fixe Champignon ϕ 58/66mm. Fixation traversante M8. Laiton verni.



3930

0013.393031 Voordeurknop vast bolrond ϕ 50/66mm. Doorgaande bevestiging M8. Messing gelakt.



Front door knob round ϕ 50/66mm. Not turnable with bolt. One side fixing M8. Brass lacquered.

Haustürknoopf kugelrond ϕ 50/66mm mit einseitiger Befestigung M8. Messing lackiert.

Bouton d'entree fixe petite boule ϕ 50/66mm. Fixation traversante M8. Laiton verni.



3930

0013.393033 Voordeurknop zwaar vast ϕ 72/80mm. Doorgaande bevestiging M8. Messing gelakt.



Front door knob heavy ϕ 72/80mm. Not turnable with bolt. One side fixing M8. Brass lacquered.

Haustürknoopf schwer ϕ 72/80mm fest mit einseitiger Befestigung M8. Messing lackiert.

Bouton d'entree fixe grande ϕ 72/80mm. Fixation traversante M8. Laiton verni.

Accessoires

Accessories

Zubehör



0099.997470



Schroefdraad met rvs eindkap t.b.v. bevestiging voordeurknop. 304 RVS geborsteld.

Change spindle for front door knob. including a cover plate. 304 brushed stainless steel.

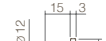

Gewindestift met Hutmutter für Haustürknoopf. Edelstahl 304 gebürstet.

Fixation traversante pour bouton d'entree. Inox mat AISI 304.

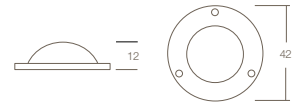

0013.397500



Afdekkplaatje tbv bout voordeurknop messing gelakt.

Cover plate for front door knob bolt brass lacquered. Abdeckplättchen für Bolzen Knopf Messing lackiert.

Cache boulon à vis laiton verni.

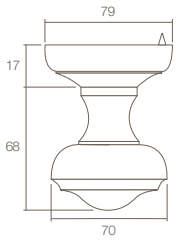

3930

0013.393034

Voordeurknop Venere vast $\varnothing 70/79$ mm.
Doorgaande bevestiging M8.
Messing gelakt.



Front door knob Venere $\varnothing 70/79$ mm.
Not turnable with bolt. One side fixing M8.
Brass lacquered.

Haustürknoopf Venere $\varnothing 70/79$ mm.
Fest mit einseitiger Befestigung M8.
Messing lackiert.

Bouton d'entree fixe Venere $\varnothing 70/79$ mm.
Fixation traversante M8.
Laiton verni.

Accessoires

Accessories

Zubehör



0099.997470



Schroefdraad met rvs eindkap t.b.v. bevestiging voordeurknop.
304 RVS geborsteld.

Change spindle for front door knob, including a cover plate.
304 brushed stainless steel.

Gewindesttift mit Hutmutter für Haustürknoopf.
Edelstahl 304 gebürstet.

Fixation traversante pour bouton d'entrée.
Inox mat AISI 304.

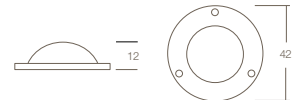
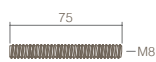

0013.397500

Afdekplaatje tbv bout voordeurknop. Messing gelakt.



Bolt cover plate. Brass lacquered.

Abdeckplatte für Bolzen. Messing lackiert.

Cache boulon a vis. Laiton verni.

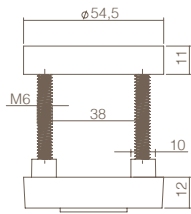

0013.375100

M6



3751

0013.375100

PC veiligheidsrozet rond verdekt met kerntrekbeveiliging. M6. Messing gelakt.



Security euro profile cylinder escutcheon round with cylinder protection. With invisible fixing M6. Brass lacquered.



PZ Schutzrosette verdeckt Rund, mit Kernziehschutz. M6. Messing lackiert.

Entrée de cylindre de haute sécurité ronde avec cache anti-forage. Fixation invisible. M6. Laiton verni.

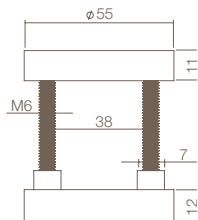
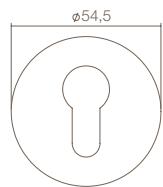

0013.375060

M6



3750

0013.375060

PC veiligheidsrozet rond verdekt. M6. Messing gelakt.



Security euro profile cylinder escutcheon. With invisible fixing. M6. Brass lacquered.



PZ Schutzrosette verdeckt. M6. Messing lackiert.

Entrée de cylindre de sécurité ronde. Fixation invisible. M6. Laiton verni.

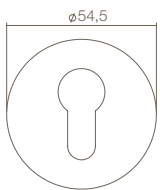

3751

0013.375130

Afde krozet binnenzijde rond. Messing gelakt.



Euro profile cylinder escutcheon round. Brass lacquered.

Schutzrosette rund. Messing lackiert.

Cache de rosace a l'interieur. Laiton verni.

Accessoires

Accessories
Zubehör



0099.990120	M6	70mm	58 - 64
0099.990122	M6	80mm	68 - 74
0099.990121	M6	90mm	78 - 84

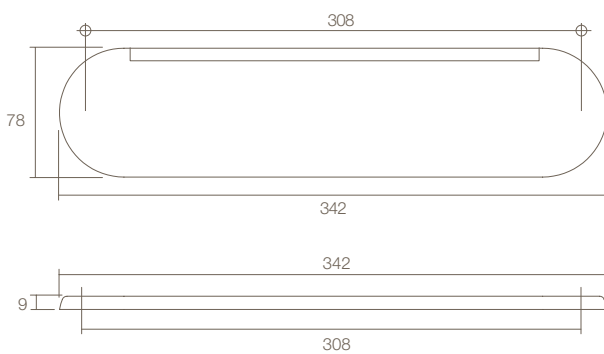
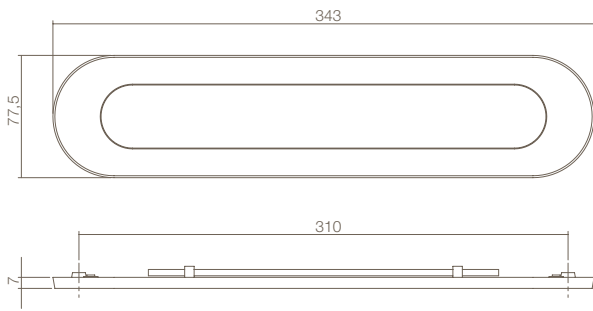

4000



0013.400005

Briefplaat ovaal met veer. Klep half naar binnen draaiend. Zowel horizontaal als verticaal te monteren. Messing gelakt.



Springloaded oval letter plate. Opens half inwards. Can be mounted both horizontally and vertically. Brass lacquered.



Briefeinwurf oval mit Feder. Klappe halb nach innen öffnend. Kann sowohl horizontal und vertikal montiert werden. Messing lackiert.

Plaque-a-lettres ovale avec ressort. S'ouvrant à moitié vers l'intérieur. Pose horizontal ou vertical. Laiton verni.

4015



0013.401500

Tochtwering ovaal met borstel en afdekklep. Messing gelakt.



Oval draught flap with brush and rain edge. Brass lacquered.



Plaque-a-lettres anti courants d'air, ovale, avec clapet. Laiton verni.

Plaque-a-lettres anti courants d'air, ovale, avec clapet. Laiton verni.

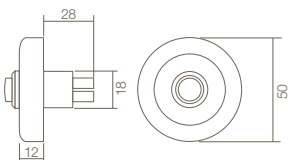
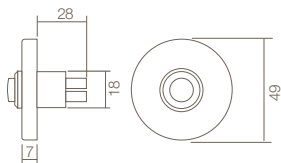
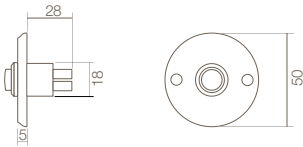
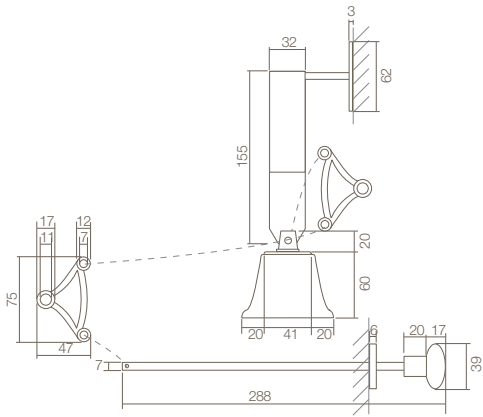

- 0013.399010** Trekbel-garnituur. Messing gelakt.
 Bell pull set. Brass lacquered.
 Zugklingelgarnitur. Messing lackiert.
 Cloche d'appel complète. Laiton verni.



- 0013.399023** Beldrukker rond. Opschroevend. Messing gelakt.
 Round bell push. Screw mounting. Brass lacquered.
 Klingelplatte rond. Schraubbar. Messing lackiert.
 Sonnette ronde. Fixation visible. Laiton verni.



- 0013.399027** Beldrukker rond verdekt. Messing gelakt.
 Round concealed bell push. Brass lacquered.
 Klingelplatte rond verdekt. Messing lackiert.
 Sonnette ronde. Fixation invisible. Laiton verni.



- 0013.399031** Beldrukker rond met rand. Verdekt. Messing gelakt.
 Concealed round bell push with edge. Brass lacquered.
 Klingelplatte rond mit Rand. Verdeckt. Messing lackiert.
 Sonnette ronde avec bord. Fixation invisible. Laiton verni.



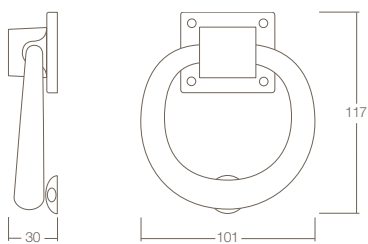
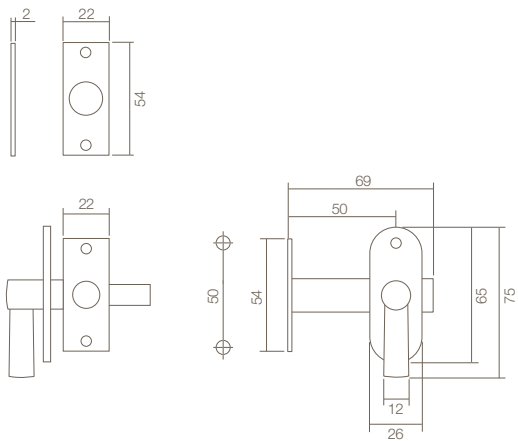
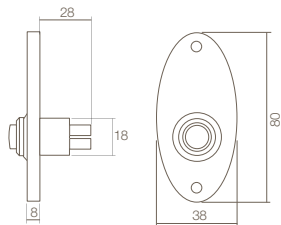
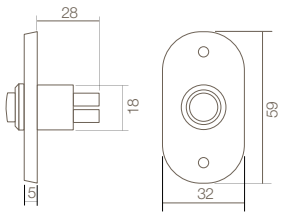

3990

0013.399025

Beldrukker ovaal. Opschroevend.
Messing gelakt.



Bell push oval. Screw mounting.
Brass lacquered.

Klingelknopf oval. Schraubbar.
Messing lackiert.

Sonnette ovale. Fixation visible. Laiton verni.



3990

0013.399028

Beldrukker ellips. Opschroevend. Messing gelakt.



Bell push ellipse model. Screw mounting.
Brass lacquered.

Klingelknopf Ellipsenmodell. Schraubbar.
Messing lackiert.

Sonnette Ellipse. Fixation visible. Laiton verni.



4055

0013.405525

Insteekgrendel. Messing gelakt.



Insert lock. Brass lacquered.

Einsteckschloss. Messing lackiert.

Verrou à larder. Laiton verni.



4035

0013.403500

Deurklopper rond. Messing gelakt.



Doorknocker round. Brass lacquered.

Türklopper rund. Messing lackiert.

Heurtoir de porte rond. Laiton verni.

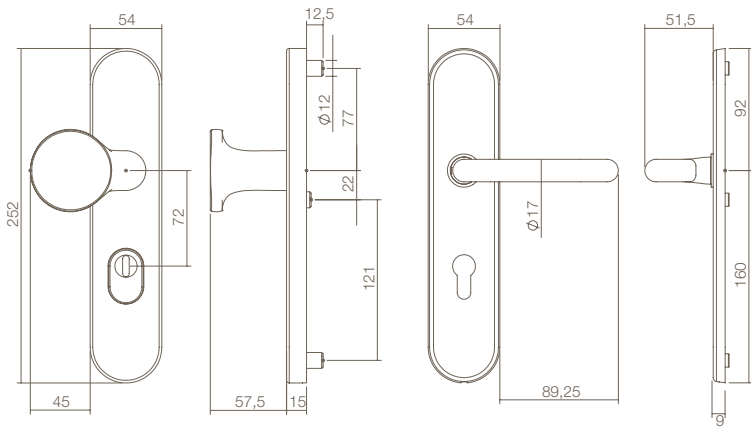

0013.382029		55mm
0013.382036		72mm
0013.382049		92mm



3820

0013.382036

PC veiligheidschilden met kerntrekbeveiliging greep/kruk los. Krukhals \varnothing 18mm. Links of rechts te monteren. Stift M14 x 8 x 75mm. Messing gelakt.

Security plates pull/lever with cylinder protection. Pull is reversible. Insert \varnothing 18mm. Spindle M14 x 8 x 75mm. Brass lacquered.

Sicherheitsgarnitur Drücker/Griffplatte mit Kernziehschutz. Rechts/links verwendbar. Drücker Hals \varnothing 18mm. Stift M14 x 8 x 75mm. Messing lackiert.

Garnitures de sécurité avec cache anti-forage et tirant fixe. Tirant réversible. Béquille seule, cou de \varnothing 18mm, droite ou gauche. Tige M14 x 8 x 75mm. Laiton verni.

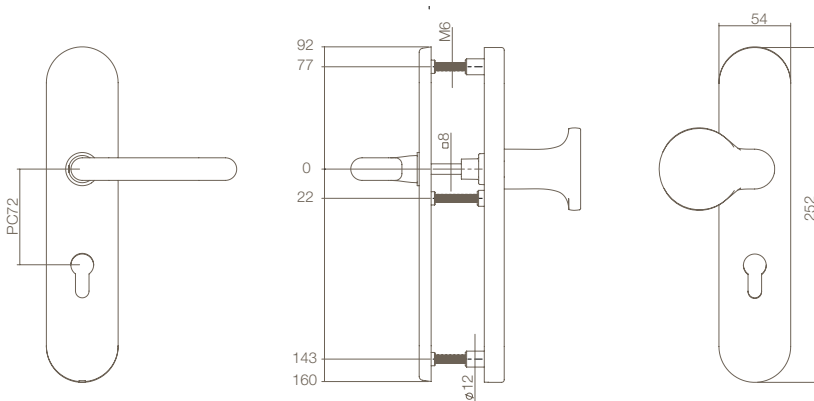

0013.384629		55mm
0013.384636		72mm
0013.384649		92mm



3846

0013.384636

PC veiligheidschilden greep/kruk los. Krukhals \varnothing 18mm. Links of rechts te monteren. Stift M14 x 8 x 75mm. Messing gelakt.

Security plates pull/lever. Pull is reversible. Insert \varnothing 18mm. Spindle M14 x 8 x 75mm. Brass lacquered.

Sicherheitsgarnitur Drücker/Griffplatte. Rechts/links verwendbar. Drücker Hals \varnothing 18mm. Stift M14 x 8 x 75mm. Messing lackiert.

Garnitures de sécurité. Tirant réversible. Béquille seule, cou de \varnothing 18mm, droite ou gauche. Tige M14 x 8 x 75mm. Laiton verni.

Accessoires

Accessories
Zubehör



0013.315620



0099.990120



0099.990122

0099.990121



0099.975343



0099.975363

0099.975364



0099.975364

M14

□ 8x75mm

□ 8x90mm

□ 8x120mm

≤ 42

≤ 60

≤ 90

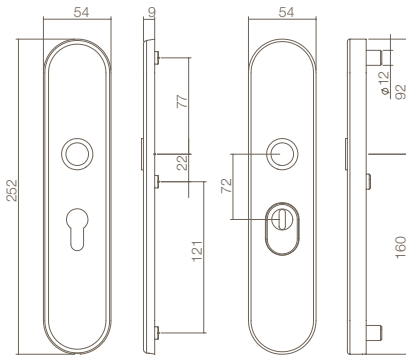

0013.382129		55mm
0013.382136		72mm
0013.382149		92mm

- Optie:** Te combineren met deurkrukken op pagina 80-89.
- Option:** Combine with doorhandles from page 80-89.
- Option:** Zu kombinieren mit Türdrücker auf Seite 80-89.
- Option:** Une combinaison possible avec les béquilles de la page 80-89.

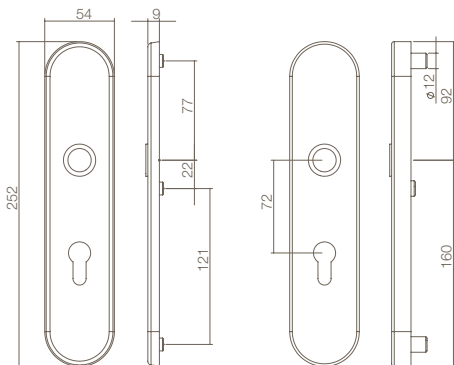

0013.381929		55mm
0013.381936		72mm
0013.381949		92mm

- Optie:** Te combineren met deurkrukken op pagina 80-89.
- Option:** Combine with doorhandles from page 80-89.
- Option:** Zu kombinieren mit Türdrücker auf Seite 80-89.
- Option:** Une combinaison possible avec les béquilles de la page 80-89.

3821



0013.382136

PC veiligheidsschilden doorgaand met kerntrekbeveiliging. Krukhals $\varnothing 18\text{mm}$. Messing gelakt.



Security plates with cylinder protection. Insert $\varnothing 18\text{mm}$. Brass lacquered.

Schutzbeschlag mit Kernziehschutz. Drücker Hals $\varnothing 18\text{mm}$. Messing lackiert.

Garnitures de sécurité avec cache anti-forage. Béquille, cou de $\varnothing 18\text{mm}$. Laiton verni.

3819



0013.381936

PC veiligheidsschilden doorgaand. Krukhals $\varnothing 18\text{mm}$. Messing gelakt.



Security plates. Insert $\varnothing 18\text{mm}$. Brass lacquered.

Schutzbeschlag durchgehend. Drücker Hals $\varnothing 18\text{mm}$. Messing lackiert.

Garnitures de sécurité. Béquille, cou de $\varnothing 18\text{mm}$. Laiton verni.

Accessoires

Accessories
Zubehör



0013.315620



0099.990120



M6



70mm



58 - 64

0099.990122

M6

80mm

68 - 74

0099.990121

M6

90mm

78 - 84



0099.975000

 \square 8x105mm ≤ 42

0099.975001

 \square 8x120mm ≤ 58

0099.975002

 \square 8x150mm ≤ 90



Messing gelakt - Brass lacquered - Messing lackiert - Laiton verni

Buitendeurbeslag - Vierkant

0013

Exterior door hardware - Square

Haustürbeschläge - Eckig

Garnitures de porte extérieure - Carrée

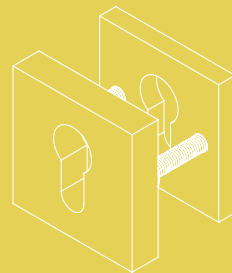

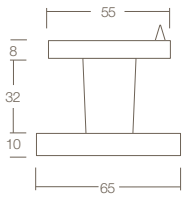

0013.393046 | | M8



3930

0013.393046 Voordeurknop vierkant vast centraal 65/55mm. Doorgaande bevestiging M8. Messing gelakt.



Front door knob square central fixed 66/55mm. Bolt through fixing M8. Brass lacquered.

Haustürknopf fest eckig 65/55mm mit durchgehender Befestigung M8. Messing lackiert.

Bouton d'entrée central fixe carrée 65/55mm. Fixation traversante M8. Laiton non verni.

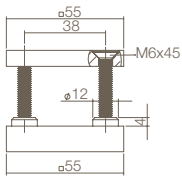

0013.375140 | | M6



3751

0013.375140 PC veiligheidsrozet massief vierkant. Zichtbare bevestiging. Messing gelakt.



Square euro profile cylinder. With visible fixing. Brass lacquered.

PZ Schutzrosette eckig. Mit sichtbarer Befestigung. Messing lackiert.

Entrée de cylindre de sécurité massive carrée. Fixation visible M6. Laiton verni.

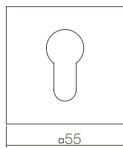

Accessoires

Accessories

Zubehör

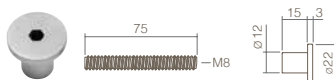

0099.997470 Schroefdraad met rvs eindkap t.b.v. bevestiging voordeurknop. 304 RVS geborsteld.



Change spindle for front door knob. including a cover plate. 304 brushed stainless steel.

Gewindestift mit Hutmutter für Haustürknopf. Edelstahl 304 gebürstet.

Fixation traversante pour bouton d'entrée. Inox mat AISI 304.



0013.397500 Afdekplaatje tbv bout voordeurknop. messing gelakt.



Cover plate for front door knob bolt. Brass lacquered.

Abdeckplättchen für Bolzen Knopf. Messing lackiert.

Cache boulon à vis. Laiton verni.



0099.990140



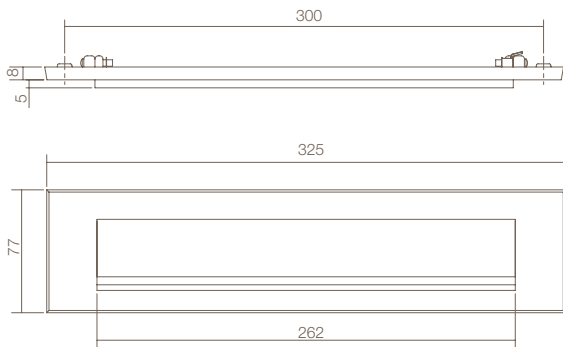

4000

0013.400001

Briefplaat rechthoekig met regenrand. Klep half naar buitendraaiend. Messing gelakt.



Letter plate square with rain edge, opens half outwards. Brass lacquered.



Briefeinwurf rechteckig mit Tropfkante. Klappe halb nach aussen öffnend. Messing lackiert.

Plaque-à-lettres rectangulaire. S'ouvrant à moitié vers l'extérieur. Laiton verni.

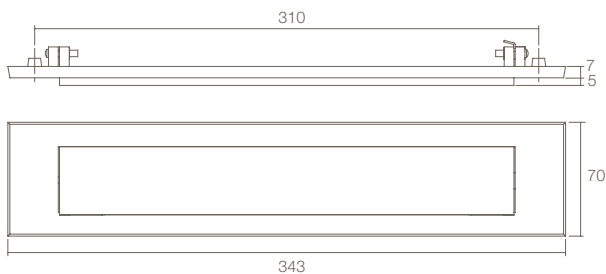

4000

0013.400003

Briefplaat rechthoekig. Klep half naar buitendraaiend. Messing gelakt.



Letter plate square with flap. Opens half outwards. Brass lacquered.



Briefeinwurf rechteckig mit Klappe. Klappe halb nach aussen öffnend. Messing lackiert.

Plaque-à-lettres rectangulaire. S'ouvrant à moitié vers l'extérieur. Laiton verni.

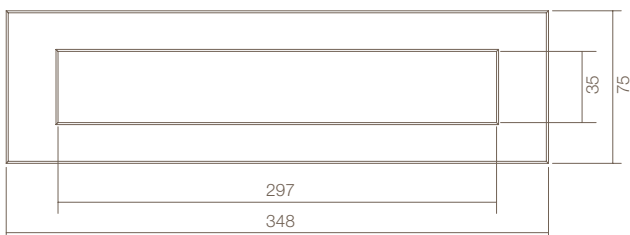

4000

0013.400004

Briefplaat rechthoekig met veer. Klep half naar binnendraaiend. Zowel horizontaal als verticaal te monteren. Messing gelakt.



Square springloaded letter plate. Opens half inwards. Can be mounted both horizontally and vertically. Brass lacquered.



Briefeinwurf rechteckig mit feder. Klappe halb nach innen öffnend. Kann sowohl horizontal und vertikal montiert werden. Messing lackiert.

Plaque-à-lettres rectangulaire avec ressort. Pose horizontal ou vertical. S'ouvrant à moitié vers l'intérieur. Laiton verni.



4015

0013.401503

Tochtwering rechthoekig met borstel. Messing gelakt.



Draught flap rectangular with brush. Brass lacquered.

Zugklappe rechteckig mit Bürstenleiste. Messing lackiert.

Plaque-à-lettres rectangulaire anti courants d'air avec brosse. Laiton verni.

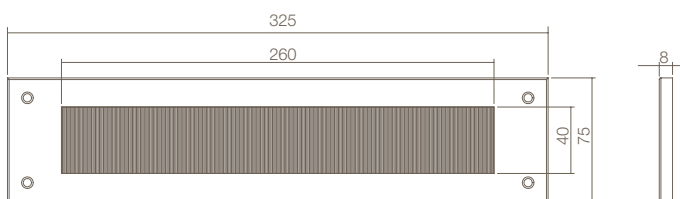

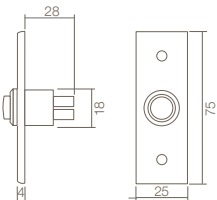
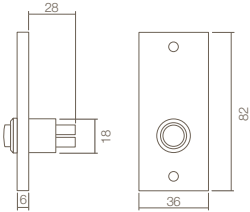
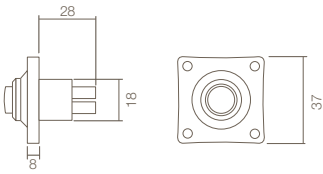
**3990****0013.399029**

Beldrukker vierkant klein. Opschroevend.
Messing gelakt.



Square bell push. Screw mounting.
Brass lacquered.

Klingelplatte eckig. Schraubbar. Messing lackiert.

Sonnette carrée petite. Fixation visible.
Laiton verni.

**3990****0013.399032**

Beldrukker rechthoekig. Opschroevend.
Messing gelakt.



Square bell push small. Screw mounting.
Brass lacquered.

Klingelplatte eckig Schmal. Schraubbar.
Messing lackiert.

Sonnette rectangulaire. Fixation visible. Laiton verni.

**3990****0013.399033**

Beldrukker rechthoekig smal. Opschroevend.
Messing gelakt.



Square bell push small. Screw mounting.
Brass lacquered.

Klingelplatte eckig Schmal. Schraubbar.
Messing lackiert.

Sonnette rectangulaire étroite. Fixation visible.
Laiton verni.

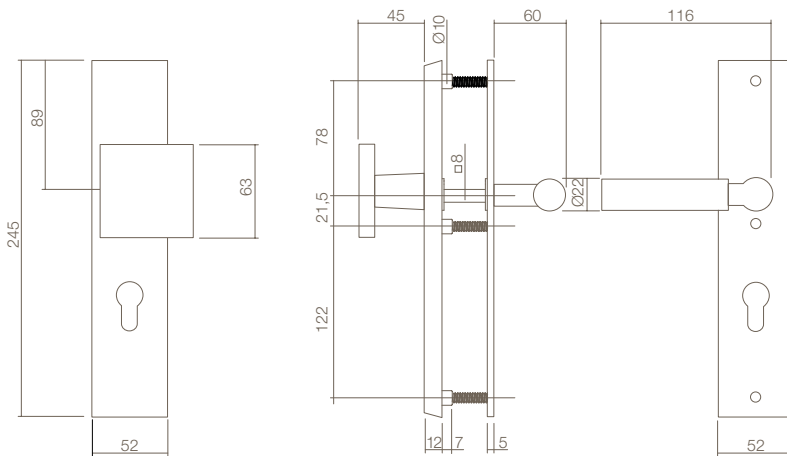

0013.382429		55mm
0013.382436		72mm

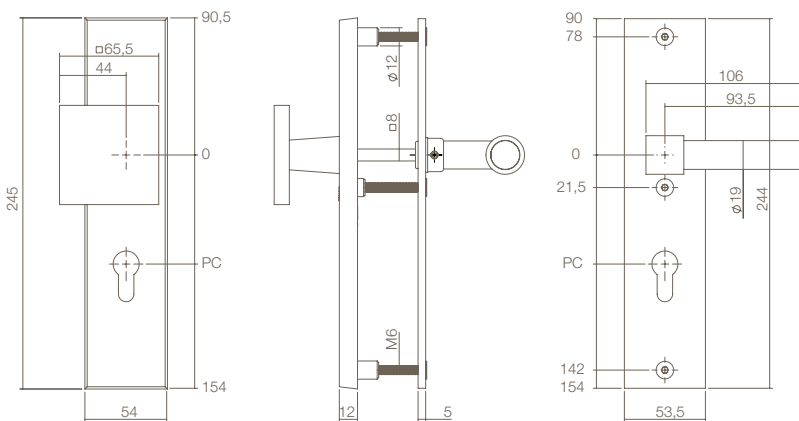

0013.390029		55mm
0013.390036		72mm
0013.390049		92mm

3824

**0013.382436**

PC veiligheidsschilden rechthoekig massief. Greep/kruk los. Krukhals \varnothing 18mm. Links of rechts te monteren. Stift M14 x 8 x 75mm. Messing gelakt.



Security plates rectangular pull/lever. Pull is reversible. Insert \varnothing 18mm. Spindle M14 x 8 x 75mm. Brass lacquered.

Sicherheitsgarnitur rechteckig Drücker/Griffplatte. Rechts/links verwendbar. Drücker Hals \varnothing 18mm. Stift M14 x 8 x 75mm. Messing lackiert.

Garnitures de sécurité rectangulaire. Tirant réversible. Béquille seule, cou de \varnothing 18mm, droite ou gauche. Tige M14 x 8 x 75mm. Laiton verni.

3900

**0013.390036**

PC veiligheidsschilden rechthoekig massief. Greep/kruk L-recht los. Krukhals \varnothing 18mm. Links of rechts te monteren. Stift M14 x 8 x 75mm. Messing gelakt.



Security plates escutcheon. Pull/lever L-straight. Pull is reversible. Insert \varnothing 18mm. Spindle M14 x 8 x 75mm. Brass lacquered.

Sicherheitsgarnitur rechteckig Langschild. Drücker/Griffplatte L-recht. Rechts/links verwendbar. Drücker Hals \varnothing 18mm. Stift M14 x 8 x 75mm. Messing unlackiert.

Garnitures de sécurité rectangulaire. Tirant réversible. Béquille modèle L-droit. Cou de \varnothing 18mm, droite ou gauche. Tige M14 x 8 x 75mm. Laiton verni.

Accessoires

Accessories
Zubehör



0099.990140



M6



90mm



78 - 84



0099.975343



M14

 \square 8x75mm \leq 42

0099.975363

M14

 \square 8x90mm \leq 60

0099.975364

M14

 \square 8x120mm \leq 90

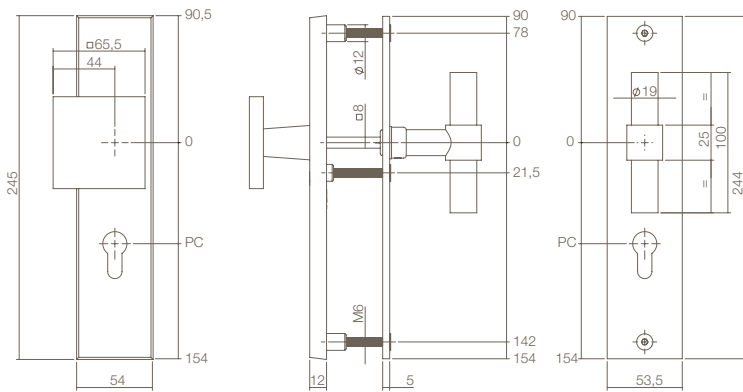

0013.390129		55mm
0013.390136		72mm
0013.390149		92mm



3901

0013.390136

PC veiligheidschilden rechthoekig massief. Greep/kruk T-recht los. Krukhals \varnothing 18mm. Links of rechts te monteren. Stift M14 x 8 x 75mm. Messing gelakt.



Security plates escutcheon. Pull/lever T-straight. Pull is reversible. Insert \varnothing 18mm. Spindle M14 x 8 x 75mm. Brass lacquered.

Sicherheitsgarnitur rechteckig Langschild. Drücker/Griffplatte T-recht. Rechts/links verwendbar. Drücker Hals \varnothing 18mm. Stift M14 x 8 x 75mm. Messing unlackiert.

Garnitures de sécurité rectangulaire. Tirant réversible. Béquille modèle T-droit. Cou de \varnothing 18mm, droite ou gauche. Tige M14 x 8 x 75mm. Laiton verni.

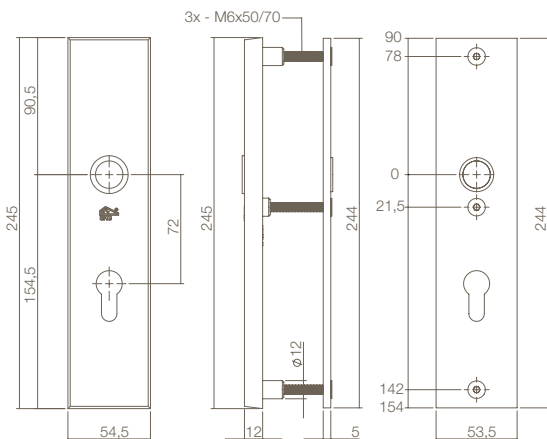

Optie:	Te combineren met deurkrukken op pagina 80-89.	0013.382529		55mm
Option:	Combine with doorhandles from page 80-89.	0013.382536		72mm
Option:	Zu kombinieren mit Türdrücker auf Seite 80-89.	0013.382549		92mm
Option:	Une combinaison possible avec les béquilles de la page 80-89.			



3825

0013.382536

PC veiligheidschilden rechthoek massief doorgaand. Krukhals \varnothing 18mm. Messing gelakt.



Security plates rectangular solid. Insert \varnothing 18mm. Brass lacquered.

Schutzbeschlag rechteckig durchgehend. Drücker Hals \varnothing 18mm. Messing lackiert.

Garniture de sécurité rectangulaire massive. Béquille, cou de \varnothing 18mm. Laiton verni.

Accessoires

Accessories

Zubehör



0013.315620



0099.990140



M6



90mm



78 - 84



0099.975343



M14

 \square 8x75mm \leq 42

0099.975363



M14

 \square 8x90mm \leq 60

0099.975364



M14

 \square 8x120mm \leq 90

0099.975000

 \square 8x105mm \leq 42

0099.975001

 \square 8x120mm \leq 58

0099.975002

 \square 8x150mm \leq 90

Messing gelakt - Brass lacquered - Messing lackiert - Laiton verni

Buitendeurbeslag - Huiscijfers

0013

Exterior door hardware - House numbers

Haustürbeschläge - Hausnummern

Garnitures de portes extérieure - Numéros de maison



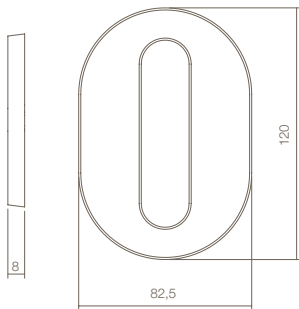

0013.402020	0	120mm
0013.402021	1	120mm
0013.402022	2	120mm
0013.402023	3	120mm
0013.402024	4	120mm
0013.402025	5	120mm
0013.402026	6	120mm
0013.402027	7	120mm
0013.402028	8	120mm
0013.402029	9	120mm



4020

0013.40202xHuiscijfer. Inclusief bevestiging.
Messing gelakt.House number. Including mounting material.
Brass lacquered.Hausnummer inkl. Befestigung.
Messing lackiert.Numero de maison. Fixation fournie.
Laiton verni.

0 1 2 3 4
5 6 7 8 9

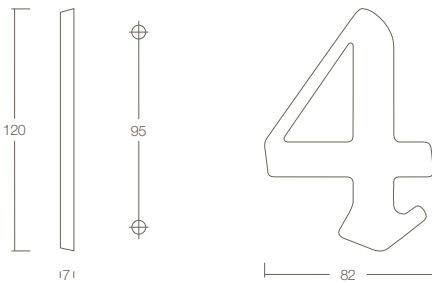

0013.402010	0	120mm
0013.402011	1	120mm
0013.402012	2	120mm
0013.402013	3	120mm
0013.402014	4	120mm
0013.402015	5	120mm
0013.402016	6	120mm
0013.402017	7	120mm
0013.402018	8	120mm
0013.402019	9	120mm



4020

0013.40201x

Huiscijfer gotisch. Messing gelakt.

House number gothic. Including mounting
material. Brass lacquered.Hausnummer gotisch inkl. Befestigung.
Messing lackiert.Numero de maison gothique.
Fixation fournie. Laiton verni.

0 1 2 3 4
5 6 7 8 9

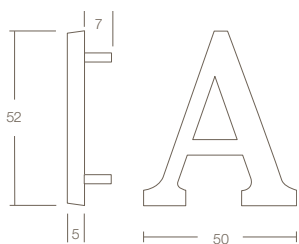

0013.402501	A	50mm
0013.402502	B	50mm
0013.402503	C	50mm



4025

0013.40250xHuisletter. Inclusief bevestiging.
Messing gelakt.House letter. Including mounting material.
Brass lacquered.Hausnummer inkl. Befestigung.
Messing lackiert.Lettre de maison. Fixation fournie.
Laiton verni.

A B C

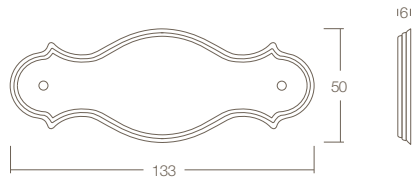
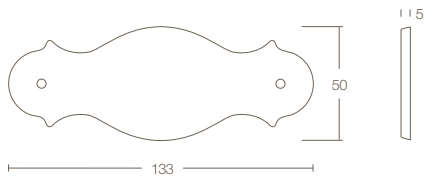

4040

0013.404002 Naamplaat. Messing gelakt.
 Name plate. Brass lacquered.
 Namenschild. Messing lackiert.
 Plaque signalétique. Laiton verni.



4040

0013.404004 Naamplaat. Messing gelakt.
 Name plate. Brass lacquered.
 Namenschild. Messing lackiert.
 Plaque signalétique. Laiton verni.



Messing gelakt - Brass lacquered - Messing lackiert - Laiton verni

Raambeslag - Raamkrukken en -sluitingen

0013

Window fittings - Window handles and closers

Fensterbeschläge - Fenstersicherung

Garnitures de fenêtre - Béquilles de fenêtre



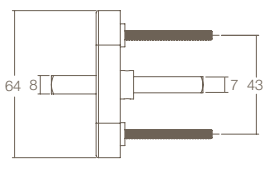
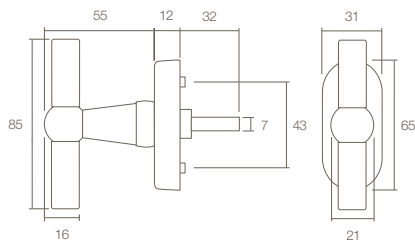
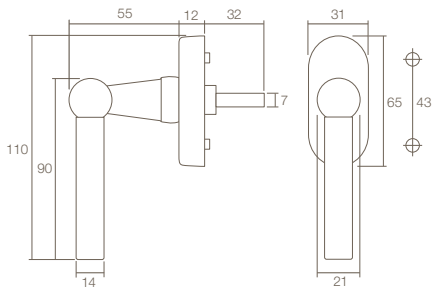

- Optie:** Te combineren met deurkrukken op pagina 80-89.
- Option:** Combine with doorhandles from page 80-89.
- Option:** Zu kombinieren mit Türdrücker auf Seite 80-89.
- Option:** Une combinaison possible avec les béquilles de la page 80-89.

6050



- 0013.605011** Raamkruk L-model. Messing gelakt.
Window handle L model. Brass lacquered.
Fenstergriff L-Modell. Messing lackiert.
Béquille de fenêtre modèle L. Laiton verni.



6050



- 0013.605013** Raamkruk T-model. Messing gelakt.
Window handle T model. Brass lacquered.
Fenstergriff T-Modell. Messing lackiert.
Béquille de fenêtre modèle T. Laiton verni.



6050



- 0013.605000** Onderconstructie tbv raamkruk met hals \varnothing 18mm. Messing gelakt.
Baseplate for window handle with a \varnothing 18mm insert. Brass lacquered.
Unterkonstruktion für Fenstergriffe mit \varnothing 18mm Drückerhals. Messing lackiert.
Sous-construction pour bequille de fenetre. Cou \varnothing 18mm. Laiton verni.



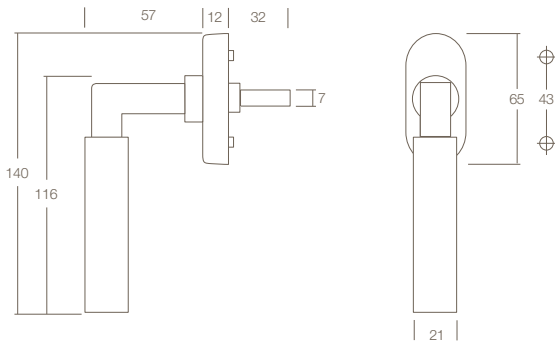

6050

0013.605090

Raamkruk Baustil. Messing gelakt.



Window handle Baustil. Brass lacquered.

Fenstergriff Baustil. Messing lackiert.

Béquille de fenêtre Baustil. Laiton verni.

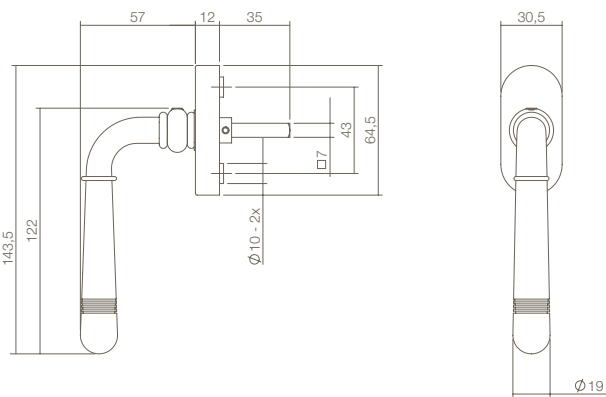

6170

0013.617050

Raamkruk Emily. Messing gelakt.



Window handle Emily. Brass lacquered.

Fenstergriff Emily. Messing lackiert.

Béquille de fenêtre Emily. Laiton verni.

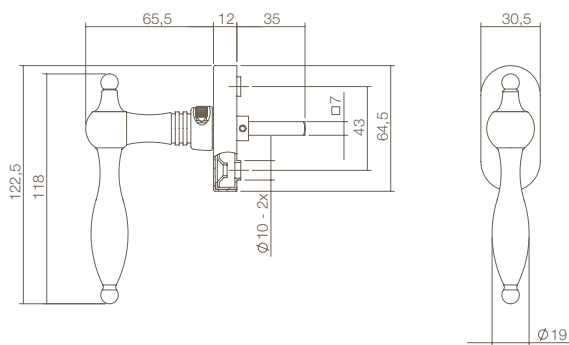

6051

0013.605120

Raamkruk Peer. Messing gelakt.

Window handle pear-shaped.
Brass lacquered.

Fenstergriff Birne. Messing lackiert.

Béquille de fenêtre Poire. Laiton verni.

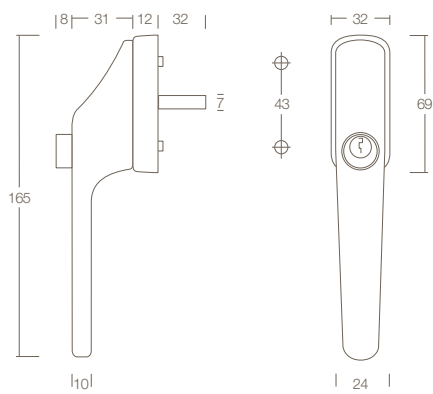
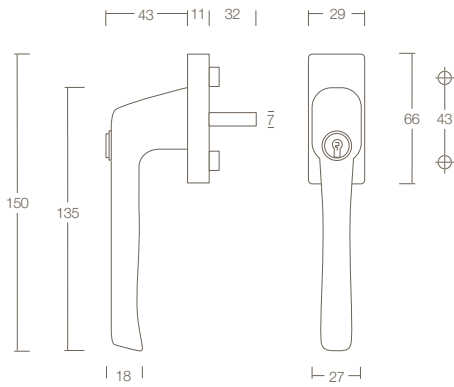

6616

0013.661610

Raamkruk zwaar afsluitbaar.
Messing gelakt.



Window handle heavy lockable.
Brass lacquered.

Fenstergriff schwer abschließbar.
Messing lackiert.

Béquille de fenêtre massive verrouillable
avec clé. Laiton verni.



6616

0013.661611

Raamkruk extra zwaar afsluitbaar.
Messing gelakt.



Window handle extra heavy lockable.
Brass lacquered.

Fenstergriff extra-schwer abschließbar.
Messing lackiert.

Béquille de fenêtre massive robuste
verrouillable avec clé. Laiton verni.

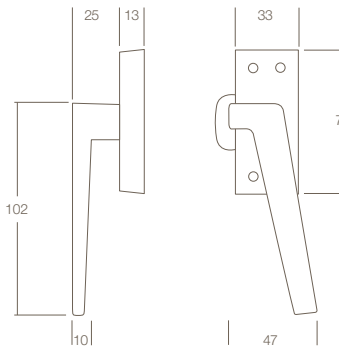

0013.561510A

0013.561510B

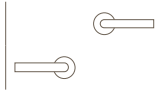

5615

0013.561510A

Raamsluiting met nok. Messing gelakt.



Window closer with lug. Brass lacquered.

Fenstersicherung mit Stütznock. Messing lackiert.

Bequille de fenetre en applique. Laiton verni.

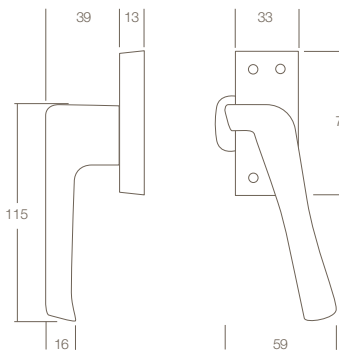

0013.561520A

0013.561520B

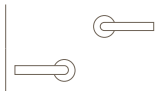

5615

0013.561520A

Raamsluiting met nok zwaar. Messing gelakt.



Window closure with lug. Brass lacquered.

Fenstersicherung mit Stütznock. Messing lackiert.

Cremone avec arret massive, droite. Laiton verni.

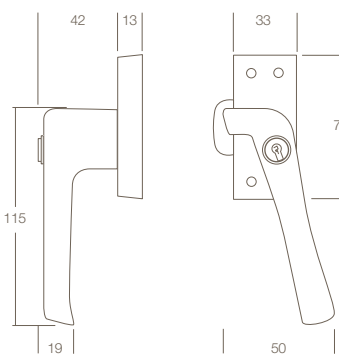

0013.561530A

0013.561530B

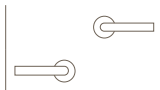

5615

0013.561530A

Afsluitbare raamsluiting met nok. Messing gelakt.



Lockable window closer with lug. Brass lacquered.

Fenstersicherung. Abschließbar mit Stütznock. Messing lackiert.

Bequille de fenetre en applique verrouillable, droite. Laiton verni.

Accessoires

Accessories
Zubehör



0013.561500

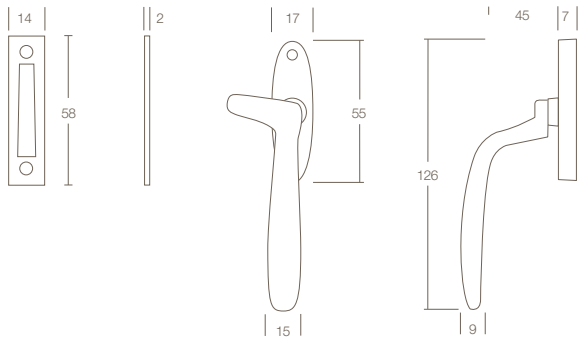

0013.561550A



0013.561550B



5615

0013.561550A

Raamsluiting Dudok. Messing gelakt.



Window closure Dudok. Brass lacquered.

Fensterschließer Dudok. Messing lackiert.

Crémone Dudok. Laiton verni.

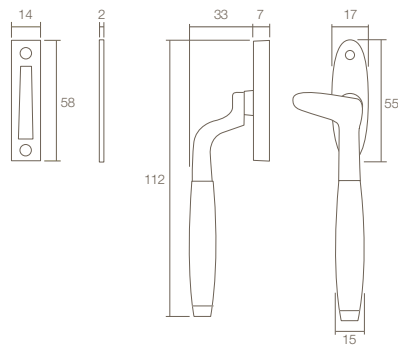

0013.561560A



0013.561560B



5615

0013.561560A

Raamsluiting. Messing gelakt/zwart hout.



Window closure. Brass lacquered/black wood.

Fensterschließer. Messing lackiert/Schwarzes Holz.

Crémone. Laiton verni/bois noir.

Accessoires

Accessories
Zubehör



0013.561541



0013.561540

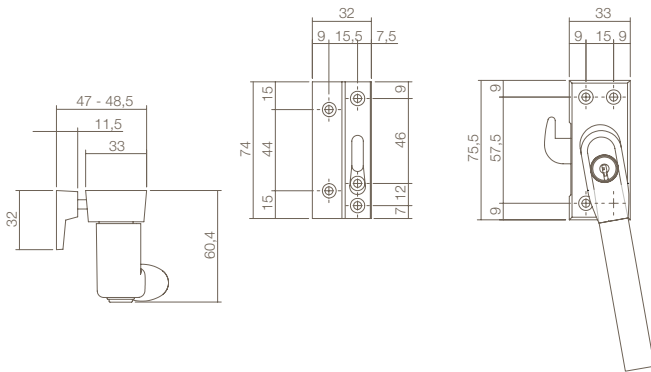

0013.661650A

0013.661651B

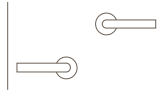

6616

0013.661650A Afsluitbare raamsluiting compleet.
Messing gelakt.



Lockable window closer straight.
Brass lacquered.



Fenstersicherung abschließbar Komplett.
Messing lackiert.

Béquille de fenêtre en applique verrouillable.
Modèle droite. Complet. Laiton verni.

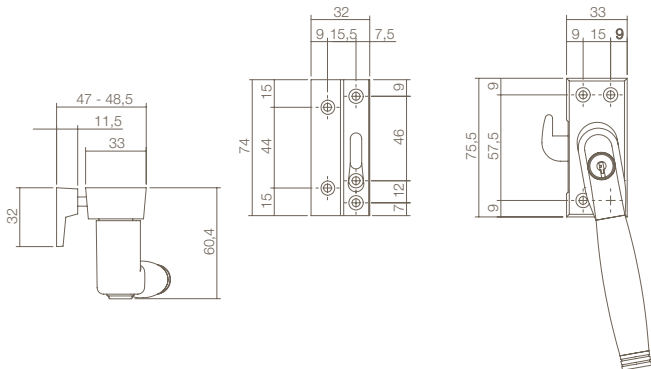

0013.661651A

0013.661651B

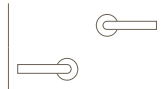

6616

0013.661651A Afsluitbare raamsluiting Ton 222.
compleet. Messing gelakt/ebbenhout.



Lockable window closer Ton 222 complete.
Brass lacquered/ebony.



Fenstersicherung abschließbar Ton 222
Komplett. Messing lackiert/Ebenholz.



Béquille de fenêtre en applique
verrouillable Ton 222. Modél droite.
Complet. Laiton verni/bois d'ebene.

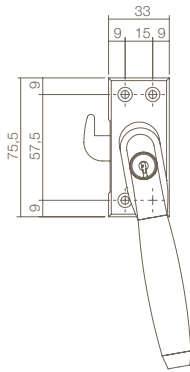
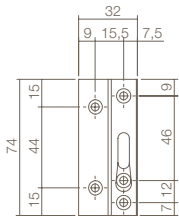

0013.661652A

0013.661652B

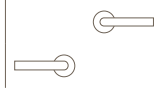

6616

0013.661652A Afsluitbare raamsluiting Ton 400 compleet.
Messing gelakt/ebbenhout.



Lockable window closer Ton 400 complete.
Brass lacquered/ebony.



Fenstersicherung abschließbar Ton 400
Komplett. Messing lackiert/Ebberholz.

Béquille de fenêtre en applique verrouillable
Ton 400. Modél droite. Complet.
Laiton verni/bois d'ebene.

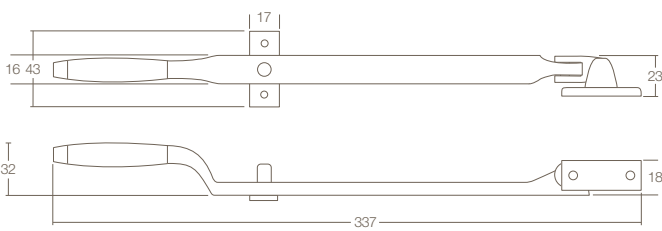
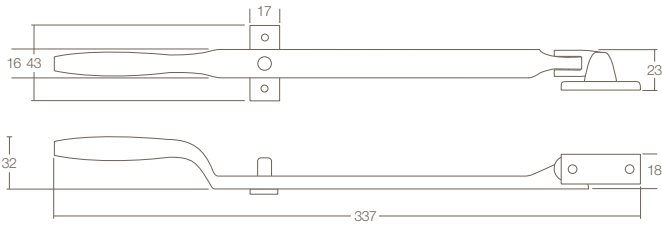

5615



0013.561580 Raamuitzetter Dudok met stelpen.
Messing gelakt.



Window casement stay. With casement stay pin. Brass lacquered.

Fensteraufsteller mit Stellstift.
Messing lackiert.

Entrebâilleur Dudok avec cheville de positionnement. Laiton verni.

5615



0013.561581 Raamuitzetter met stelpen.
Messing gelakt/zwart hout.



Window casement stay. With casement stay pin. Brass lacquered/black wood.

Fensteraufsteller mit Stellstift.
Messing lackiert/Schwarzes Holz.

Entrebâilleur avec cheville de positionnement.
Laiton verni/bois noir.

Accessoires

Accessories
Zubehör



0013.561589



Messing gelakt - Brass lacquered - Messing lackiert - Laiton verni

Toebehoren - Espagnoletten

0013

Accessories - Espagnolette

Zubehör - Espagnolette

Accessoires - Espagnolette



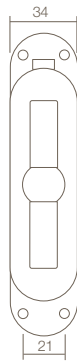
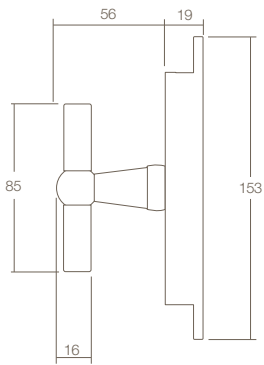

5620

0013.562020

Espagnolette T-model. Brass lacquered.



Espagnolette T-model. Brass lacquered.

Espagnolette T-Modell. Messing lackiert.

Cremone kit "T". Laiton verni.

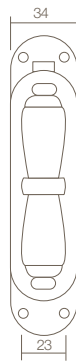
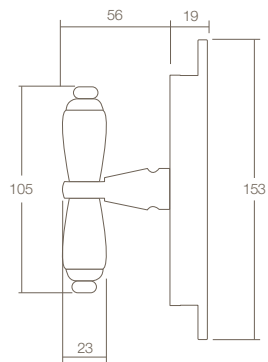

5620

0013.562025

Espagnolet kruiskruk. Messing gelakt/zwart.

Espagnolette T-model.
Brass lacquered/black.Espagnolette T-Modell.
Messing lackiert/schwarz.

Cremone kit "T". Laiton verni/noir.

Accessoires Accessories Zubehör



0013.562000



0013.562001



0013.562002

0013.562007
2 x 125cm

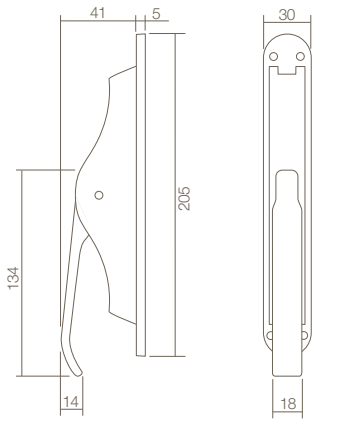

5620



0013.562030

Pomp-espagnolet. Messing gelakt.



Pump espagnolet. Brass lacquered.

Pump-Espagnolet. Messing lackiert.

Espagnolette à levier. Laiton verni.

Accessoires

Accessories
Zubehör



0013.562000



0013.562001



0013.562002

0013.562004
2 x 125cm

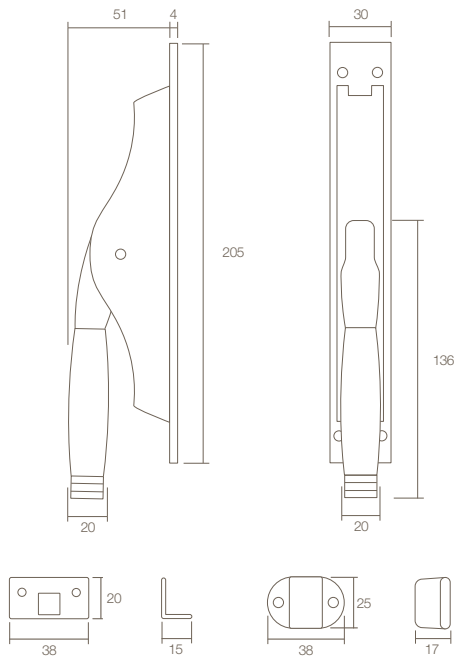

0013.562035

Pomp-espagnolet Ton 222.
Messing gelakt/ebbenhout.



Pump espagnolet Ton 222.
Brass lacquered/ebony.

Pump-Espagnolet Ton 222.
Messing lackiert/Ebenholz.

Espagnolette à levier Ton 222.
Laiton verni/bois d'ébène.

Accessoires

Accessories
Zubehör



0013.562000



0013.562001



0013.562002



0013.562004
2 x 125cm

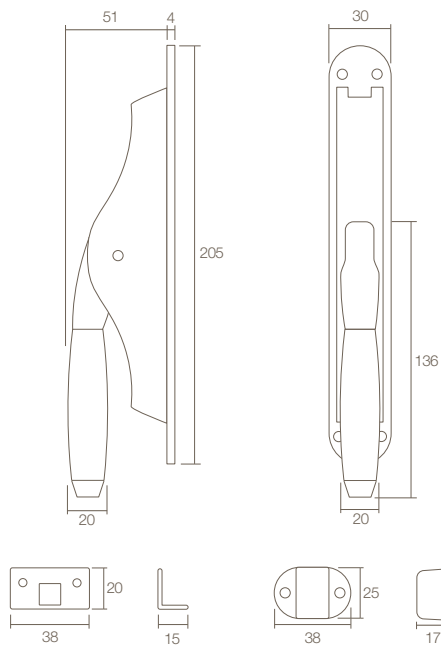

5620

0013.562036

Pomp-espagnolet Ton 400.
Messing gelakt/ebbenhout.



Pump espagnolet Ton 400.
Brass lacquered/ebony.

Pump-Espagnolet Ton 400.
Messing lackiert/Ebenholz.

Espagnolette à levier Ton 400.
Laiton verni/bois d'ébène.

Accessoires

Accessories
Zubehör



0013.562000



0013.562001



0013.562002



0013.562004
2 x 125cm

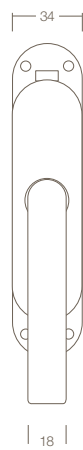
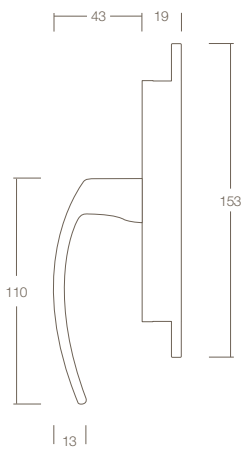

0013.562050A

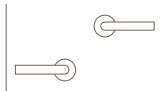

0013.562050B

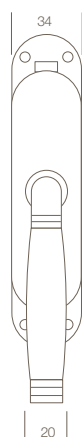
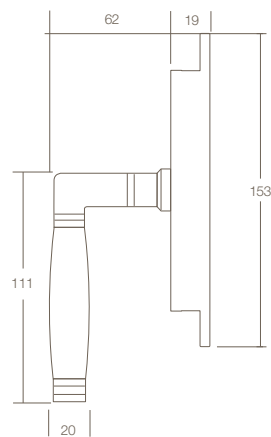

0013.562060A

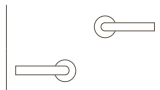

0013.562060B



5620

0013.562050A

Kruk-espagnolet. Messing gelakt.



Handle espagnolet right. Brass lacquered.

Klinken-Espagnolet rechts. Messing lackiert.

Crémone béquille droite. Laiton verni.



5620

0013.562060A

Kruk-espagnolet Ton 222.
Messing gelakt/ebenhout.Handle espagnolet Ton 222.
Brass lacquered/ebony.Klinken-Espagnolet Ton 222.
Messing lackiert/Ebenholz.Crémone kit Ton 222 droite.
Laiton verni/bois d'ebene.

Accessoires

Accessories
Zubehör



0013.562000



0013.562001



0013.562002

0013.562007
2 x 125cm

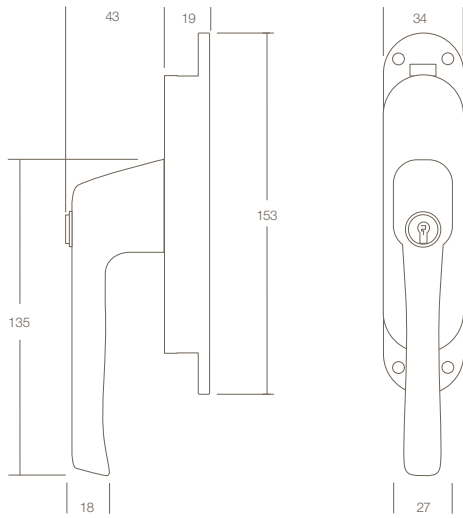

0013.562070A

0013.562070B

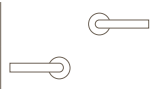

5620

0013.562070A Afsluitbare kruk-espagnolet. Messing gelakt.

 Lockable handle espagnolet.
Brass lacquered.

 Abschließbares Klinken-Espagnolet.
Messing lackiert.

 Béquille de crémone verrouillable droite.
Laiton verni.

Accessoires

Accessories
Zubehör



0013.562000



0013.562001



0013.562002

0013.562007
2 x 125cm

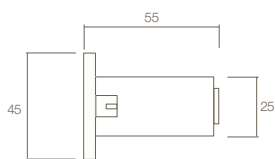
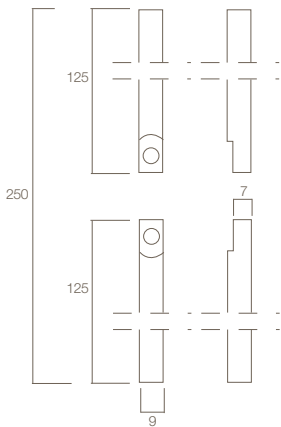
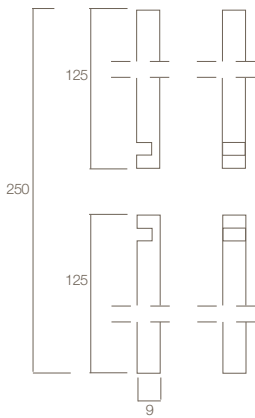

5620

0013.562004

Stagenset tbv pomp-espagnolet. 2 x 125cm.
Messing gelakt.



Rods set for espagnolette. 2 x 125cm.
Brass lacquered.

Stagen set für Espagnolette. 2 x 125cm.
Messing lackiert.

Set tringles pour espagnolette à levier.
2 x 125cm. Laiton verni.



5620

0013.562007

Stagenset tbv kruk-espagnolet. 2 x 125cm.
Messing gelakt.



Rods set for espagnolette. 2 x 125cm.
Brass lacquered.

Stagen set für Espagnolette. 2 x 125cm.
Messing lackiert.

Set tringles pour espagnolette à levier.
2 x 125cm. Laiton verni.



5620

0013.562002

Espagnoletslot. Messing gelakt.



Espagnolet lock. Brass lacquered.

Espagnolet-Schloss. Messing lackiert.

Verou pour espagnolette. Laiton verni.

Accessoires

Accessories
Zubehör



0013.562000



0013.562001

Messing gelakt - Brass lacquered - Messing lackiert - Laiton verni

Toebehoren - Sierhulzen

0013

Accessories - Hinge covers

Zubehör - Übersteckhüls

Accessoires - Caches-paumelles



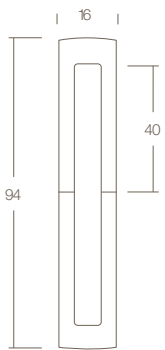

ø14mm

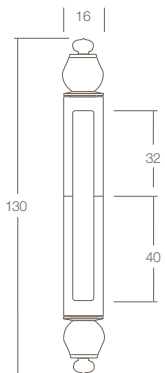

ø14mm



4540

0013.454000

Sierhuls stomp 40/40mm voor paumel ø14mm. Messing gelakt.



Decorative hinge cover 40/40mm. Brass lacquered.

Übersteckhüls 40/40mm. Messing lackiert.

Cache-paumelles moderne 40/40mm pour paumelles ø14mm. Laiton verni.



4540

0013.454001

Sierhuls met knop 32/40mm voor paumel ø14mm. Messing gelakt.



Decorative hinge cover 32/40mm. Brass lacquered.

Übersteckhüls 32/40mm. Messing lackiert.

Cache-paumelles avec bouton 32/40mm pour paumelles ø14mm. Laiton verni.

Messing gelakt - Brass lacquered - Messing lackiert - Laiton verni

Toebehoren - Deurstoppers

0013

Accessories - Doorstops

Zubehör - Türstopper

Accessoires - Butoirs de porte

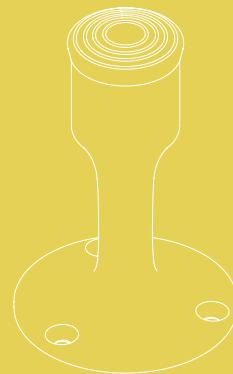

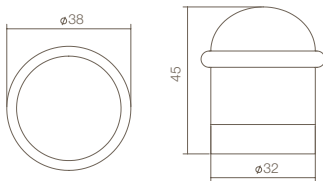

4420

0013.442000

Deurstop met ring. Vloermontage.
Messing gelakt.



Doorstop with ring. Floor mounting.
Brass lacquered.

Türstopper mit Ring. Bodenmontage.
Messing lackiert.

Butoir de porte avec bague.
Pose au sol. Laiton verni

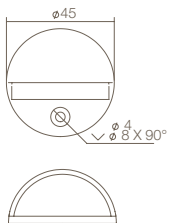

4420

0013.442020

Deurstop rond model. Vloermontage.
Messing gelakt.



Doorstop round. Floor mounting.
Brass lacquered.

Türstopper Rund. Bodenmontage.
Messing lackiert.

Butoir de porte modèle rond. Pose au sol.
Laiton verni.

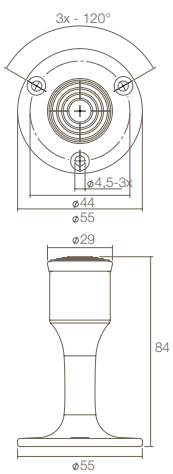

4420

0013.442040

Deurstop recht model. Wandmontage.
Messing gelakt.



Doorstop straight. Wall mounting.
Brass lacquered.

Türstopper recht. Wandmontage.
Messing lackiert.

Butoir modèle droit. Pose mural.
Laiton verni.

Messing gelakt - Brass lacquered - Messing lackiert - Laiton verni

Toebehoren - Schuifdeurbeslag

0013

Accessories - Sliding door fittings

Zubehör - Schiebetürbeschläge

Accessoires - Ferrures de portes coulissantes

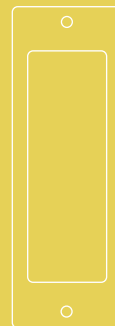

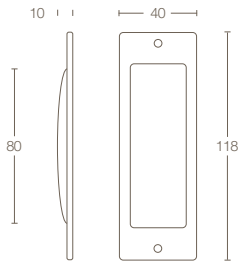

4476

0013.447600 Schuifdeurkom 120x40mm. Messing gelakt.



Flush pull 120x40mm. Brass lacquered.

Schiebetürmuschel 120x40mm.
Messing lackiert.

Poignee cuvette 120x40mm. Laiton verni.

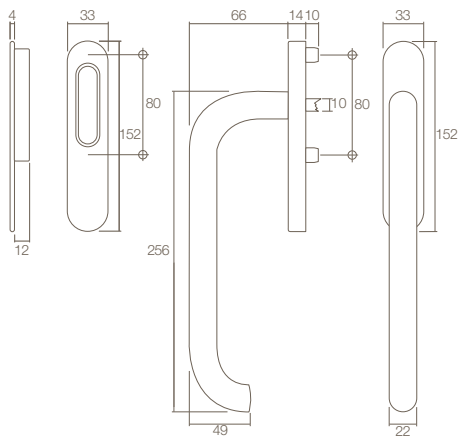

4476

0013.450021 Hef-/schuifdeurbeslag 265mm
profielcilindergat 69mm. Messing gelakt.



Lifting/sliding door fitting 265 mm PC69.
Brass lacquered.

Hebe-/Schiebetürbeslag 265 mm PZ69.
Messing lackiert.

Poignée pour porte coulissante 265mm trou
de cylindre 69mm. Laiton verni.

Messing gelakt - Brass lacquered - Messing lackiert - Laiton verni

Toebehoren - Deurgrepen

0013

Accessories - Pull handles

Zubehör - Stoßgriffe

Accessoires - Tirants

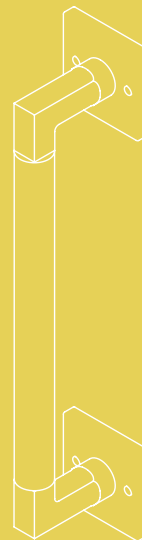

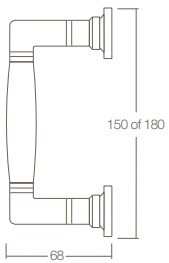
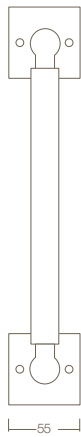
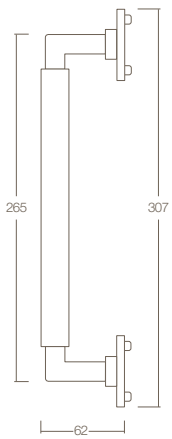

0013.426192	75/150mm
0013.426193	110/180mm

4261



0013.426190

Deurgreep Bau-Stil 250mm op vierkant rozet.
Eenzijdige bevestiging. Messing gelakt.



Pull handle Bau-Stil 250mm on round rose.
One side fixing. Brass lacquered.

Stoßgriff Bau-Stil 250mm auf runder Rosette.
Einseitiger Befestigung. Messing lackiert.

Tirant modèle Bau-Stil 250mm fixe sur
rosace carrée. Montage unilatérale.
Laiton verni.

4261



0013.426193

Deurgreep Ton 110/180mm op vierkant
rozet. Eenzijdige bevestiging.
Messing gelakt/ebbenhout.



Pull handle Ton 110/180mm on square rose.
One side fixing. Brass lacquered.

Stoßgriff Ton 110/180mm auf eckige
Rosette. Einseitiger Befestigung.
Messing lackiert/Ebenholz.

Tirant modele Ton 110/180mm fixe sur
rosace carree. Montage unilatérale.
Laiton verni/bois d'ebene.

Messing gelakt - Brass lacquered - Messing lackiert - Laiton verni

Toebehoren - Meubelgrepen en -knoppen

0013

Accessories - Furniture handles and knobs

Zubehör - Möbelgriffe und -knoppen

Accessoires - Poignées de meubles

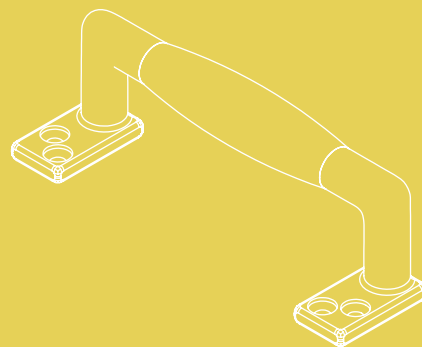

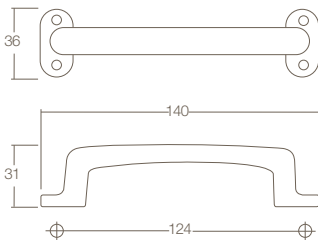

0013.561590
0013.561591

A
110mm
140mm

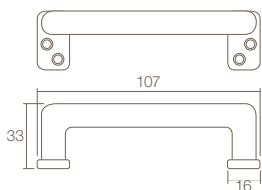
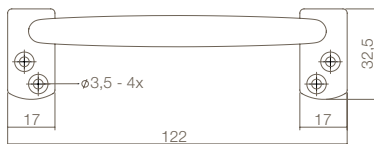
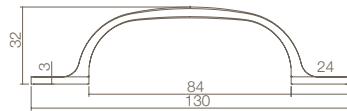
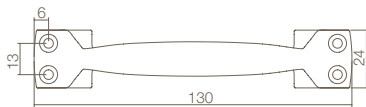

5615

0013.561590 Handgreep 777. Messing gelakt.
Furniture handle 777. Brass lacquered.
 10 Handgriff 777. Messing lackiert.
Poignée 777. Laiton verni.



5616

0013.561600 Handgreep op vierkante voet 130mm. Messing gelakt.
 10 Furniture handle on square foot 130mm. Brass lacquered.
Möbelgriff mit eckiger Basis 130mm. Messing lackiert.
Poignée avec une base carrée 130mm. Laiton verni.



5616

0013.561601 Handgreep Haags model 120mm. Messing gelakt.
 10 Furniture handle "Haags" model 120mm. Brass lacquered.
Handgriff Haags-Modell 120mm. Messing lackiert.
Poignée modèle La Haye 120mm. Laiton verni.



5616

0013.561620 Handgreep recht 107mm. Messing gelakt.
 10 Furniture handle straight 107 mm. Brass lacquered.
Möbelgriff recht 107mm. Messing lackiert.
Poignée modèle droit 107mm. Laiton verni.

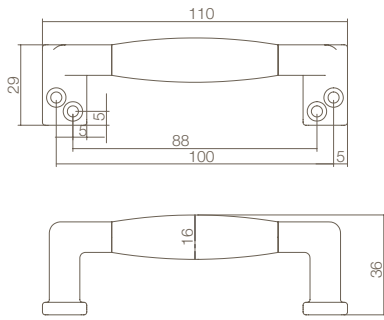

5616

0013.561640 Handgreep recht 110mm.
Messing gelakt/ebbenhout.



Furniture handle straight 110mm.
Brass lacquered/ebony.

Möbelgriff recht 110mm.
Messing lackiert/Ebenholz.

Poignée modèle droit 110mm.
Laiton verni/bois d'ebene.

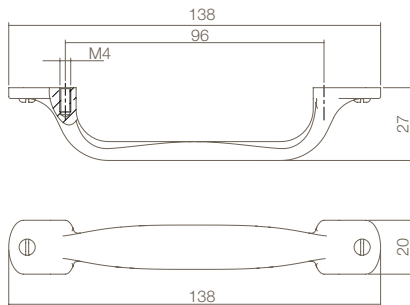

8752

0013.875280 Handgreep kort 96mm. Messing gelakt.



Furniture handle short 96 mm.
Brass lacquered.

Handgriff kurz 96 mm. Messing lackiert.

Poignée de meuble courte 96mm.
Laiton verni.

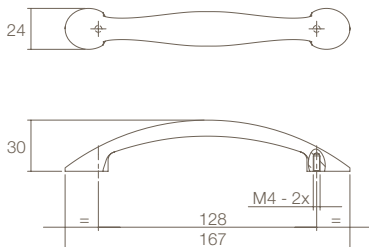

8753

0013.875300 Handgreep 128/167mm. Messing gelakt.



Furniture handle 128/167 mm.
Brass lacquered.

Handgriff 128/167 mm. Messing lackiert.

Poignée de meuble 128/167mm. Laiton verni.

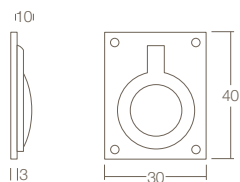

7525

0013.752510 | 40x30mm

0013.752520 | 51x38mm

0013.752530 | 60x47mm

0013.752510 Luikring recht. Messing gelakt.



Hatch ring. Brass lacquered.

Lukenring. Messing lackiert.

Anneau pour trappe rectangulaire.
Laiton verni.

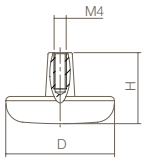

	D	H
0013.847600	28mm	22mm

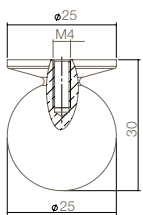

	D	H
0013.847661	20mm	25mm
0013.847662	25mm	30mm
0013.847663	30mm	35mm
0013.847664	35mm	40mm

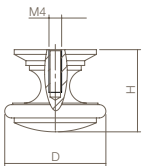

	D	H
0013.847771	21mm	20,5mm
0013.847773	32mm	26mm
0013.847774	40mm	30mm

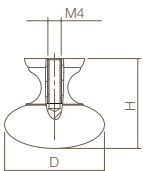

	D	H
0013.847810	25mm	24mm
0013.847811	30mm	27mm
0013.847813	40mm	32mm



8476

0013.847600 Knop plat vermessingd.
 Knob flat brass lacquered.
 Knopf flach Messing lackiert.
 Bouton de meuble plat laiton verni.



8476

0013.847661 Knop plat. Messing gelakt
 Flat knob. Brass lacquered.
 Knopf kugelrund. Messing lackiert.
 Bouton de meuble boule avec rosace fixe. Laiton verni.



8477

0013.847771 Knop afgerond. Messing gelakt.
 Knob rounded. Brass lacquered.
 Knopf abgerundet. Messing lackiert.
 Bouton de meuble arrondi. Laiton verni.



8478

0013.847810 Knop paddenstoel. Messing gelakt.
 Knob mushroom. Brass lacquered.
 Knopf Pilz. Messing lackiert.
 Bouton de meuble Champignon. Laiton verni.



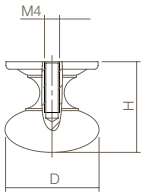

0013.847822

D
30mmH
29mm

0013.847823

D
35mmH
34mm

8478

0013.847822Knop paddenstoel met achterplaat 30mm.
Messing gelakt.Knob mushroom with back plate 30 mm.
Brass lacquered.Knopf Paddestoel mit Hinterplatte 30mm.
Messing lackiert.Bouton de meuble Champignon avec rosace
fixe 30mm. Laiton verni.



Messing gelakt - Brass lacquered - Messing lackiert - Laiton verni

Toebehoren - Garderobe

0013

Accessories - Coat rack

Zubehör - Garderoben

Accessoires - Porte-manteaux



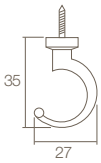

	D	H
0013.692500	20mm	18mm
0013.692501	28mm	21mm
0013.692502	35mm	27mm
0013.692503	42mm	32mm
0013.692504	50mm	38mm

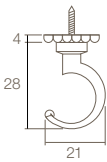

	D	H
0013.692511	28mm	21mm
0013.692512	35mm	27mm
0013.692513	42mm	32mm
0013.692514	50mm	38mm

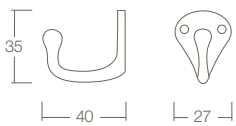

6925

0013.692502

Haak messing gelakt.



Hook brass lacquered.

Haken Messing lackiert.

Crochet laiton verni.



6925

0013.692511

Haak met achterplaat. Messing gelakt.



Hook with back plate. Brass lacquered.

Haken mit Hinterplatte. Messing lackiert.

Crochet avec bague. Laiton verni.



6926

0013.692611

Jashaak scheepsmodel enkel.
Messing gelakt.Coat hook ship model single.
Brass lacquered.Mantelhaken Schiffsmodell einzeln.
Messing lackiert.

Crochet modèle bateau simple. Laiton verni.

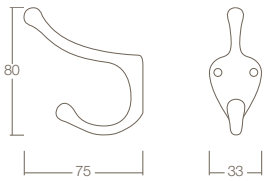

6926

0013.692612 Kapstokhaak scheepsmodel lang.
Messing gelakt.



Hat & coat hook ship model long.
Brass lacquered.

Huthaken Schiffsmodell lang.
Messing lackiert.

Crochet port-manteau modèle bateau.
Laiton verni.

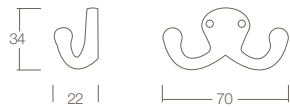

6926

0013.692613 Jashaak scheepsmodel dubbel.
Messing gelakt.



Coat hook ship model double.
Brass lacquered.

Mantelhaken Schiffsmodell doppelt.
Messing lackiert.

Crochet modèle bateau double.
Laiton verni.

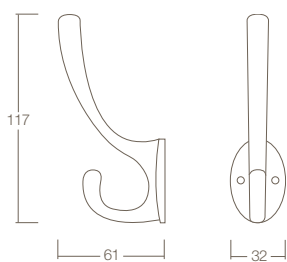

6926

0013.692620 Kapstokhaak ovaal. Messing gelakt.



Hat & coat hook oval. Brass lacquered.

Huthaken ovaal. Messing lackiert.

Crochet port-manteau modèle ovale.
Laiton verni.



Messing gelakt - Brass lacquered - Messing lackiert - Laiton verni

Toebehoren - Leuninghouders

0013

Accessories - Handrail brackets

Zubehör - Handlaufstützen

Accessoires - Supports de rampe

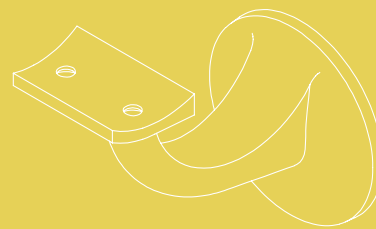

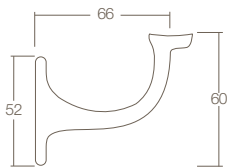
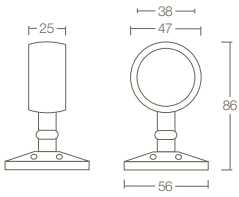

0013.724520

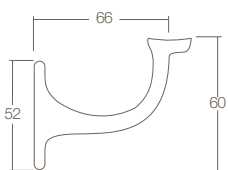

0013.724521



7245

0013.724500

Leuning/touwoog. Messing gelakt.



Handrail/rope eye. Brass lacquered.

Geländer/Seilführung. Messing lackiert.

Support de corde. Laiton verni.



7245

0013.724520

Leuninghouder opschroevend vlak zadel.
Messing gelakt.Handrail bracket screw-on flat saddle.
Brass lacquered.Geländerhalter Schraubbar flach Sattel.
Messing lackiert.Support de rampe, plaque avec trous de vis,
selle plate. Laiton verni.

7245

0013.724521

Leuninghouder opschroevend hol zadel
messing gelakt.Handrail bracket screw-on hollow saddle
brass lacquered.Geländerhalter Schraubbar hohl Sattel
Messing lackiert.Support de rampe, plaque avec trous de vis,
selle creuse, laiton verni.

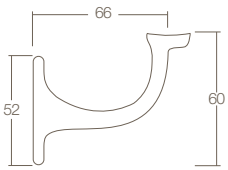

0013.724530



M8

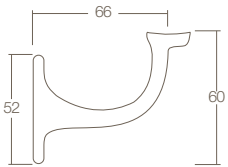

0013.724531



M8



7245

0013.724530

Leuninghouder centraal M8. Vlak zadel.
Blinde bevestiging. Messing gelakt.



Concealed handrail bracket M8.
Flat saddle. Brass lacquered.

Handlaufstütze M8. Flach Sattel.
Verdeckt. Messing lackiert.

Support de rampe. Plaque avec trou M8.
Selle plate. Aveugle. Laiton verni.



7245

0013.724531

Leuninghouder centraal M8. Hol zadel.
Blinde bevestiging. Messing gelakt.



Concealed handrail bracket M8.
Hollow saddle. Brass lacquered.

Handlaufstütze M8. Hohl Sattel.
Verdeckt. Messing lackiert.

Support de rampe. Plaque avec trou M8.
Selle creuse. Aveugle. Laiton verni.



Messing gelakt - Brass lacquered - Messing lackiert - Laiton verni

Toebehoren - Deurspionen

0013

Accessories - Doorviewers

Zubehör - Türspionen

Accessoires - Judas de porte

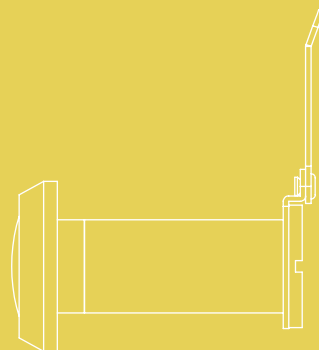

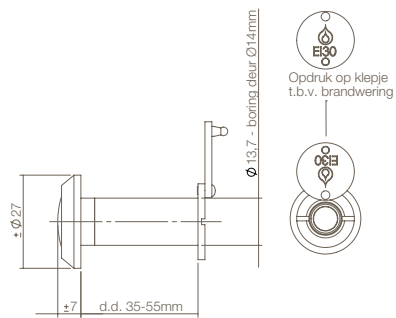
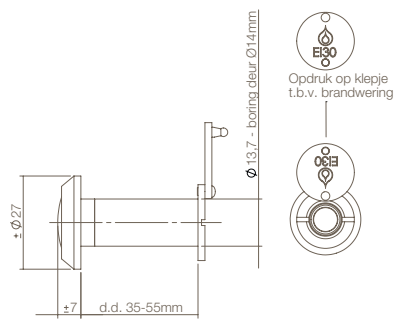
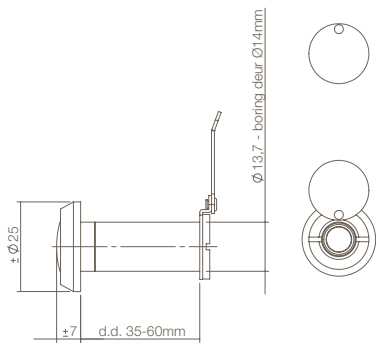

4055



- 0013.405530** Deurspion 180°. Messing gelakt.
 Door viewer 180°. Brass lacquered.
 Turspione 180°. Messing lackiert.
 Judas optique. Angle de vision 180°.
 Laiton verni.



4055



- 0013.405531** Deurspion 200°. 30 min. brandwerend.
 Messing gelakt.
 Doorviewer 200°. 30 min. Fire proof.
 Brass lacquered.
 Turspione 200°. Messing lackiert. 30 min.
 feuerfest.
 Judas optique. Angle de vision 200°.
 Coupe-feu 30 min. Laiton verni.



4055



- 0013.405532** Deurspion 200°. 60 min. brandwerend.
 Messing gelakt.
 Doorviewer 200°. 60 min. Fire proof.
 Brass lacquered.
 Turspione 200°. Messing lackiert. 60 min.
 feuerfest.
 Judas optique. Angle de vision 200°.
 Coupe-feu 60 min. Laiton verni.



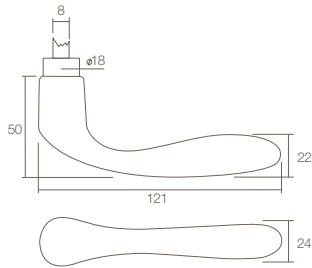

0021.020100

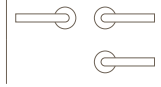

0021.020100A



0201

0021.020100

Deurkruk Banaan. Oud grijs.



Door handle Banaan. Old grey.



Türdrücker Banaan. Alt grau.

Béquille Banane. Vieux gris.

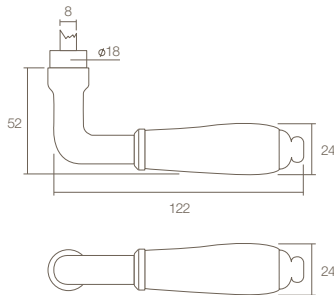

0021.020500

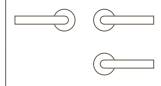

0021.020500A



0205

0021.020500

Deurkruk Courgette. Oud grijs.



Door handle courgette. Old grey.



Türdrücker Courgette. Alt grau.

Béquille Courgette. Vieux gris.

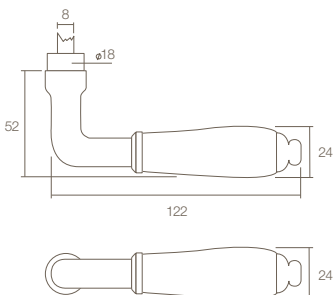

0021.020600

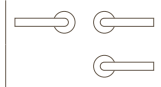

0021.020600A



0206

0021.020600

Deurkruk Courgette. Oud grijs/mat zwart.



Door handle courgette. Old grey/satin black.



Türdrücker Courgette. Alt grau/mattschwarz.

Béquille Courgette. Vieux gris/noir mat.

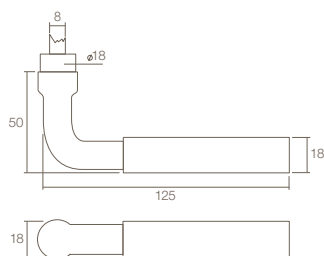

0021.021500

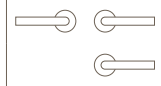

0021.021500A



0215

0021.021500

Deurkruk Palma. Oud grijs.



Door handle Palma. Old grey.



Türdrücker Palma. Alt grau.

Béquille Palma. Vieux gris.

Accessoires Accessories Zubehör



0021.318604



0021.318616



0021.318617



0021.318660

8mm



0021.370560

8mm

0021.370660

8mm verlengd



0021.370960

8mm

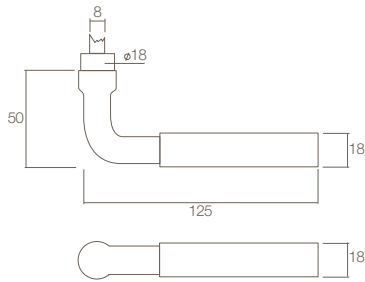

0021.021700

0021.021700A

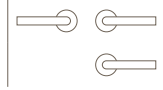

0217

0021.021700

Deurkruk Palma. Oud grijs/zwart.

Door handle Palma. Old grey/black.

Türdrücker Palma. Alt grau/schwarz.

Béquille Palma. Vieux gris/noir.

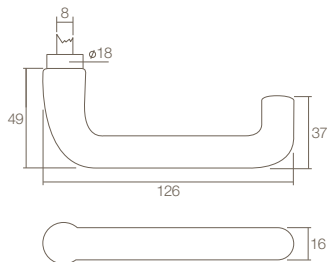

0021.023400

0021.023400A

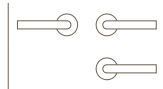

0217

0021.023400

Deurkruk Rond. Oud grijs.

Door handle round. Old grey.

Türdrücker rund. Alt grau.

Béquille modèle U. Vieux gris.

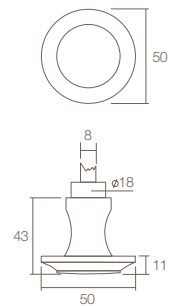

0021.025400

0021.025400A

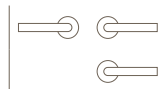

0254

0021.025400

Knopkruk 50mm. Oud grijs.

Knob handle 50mm. Old grey.

Knopfdrucker 50 mm. Alt grau.

Béquille Bouton 50mm. Vieux gris.

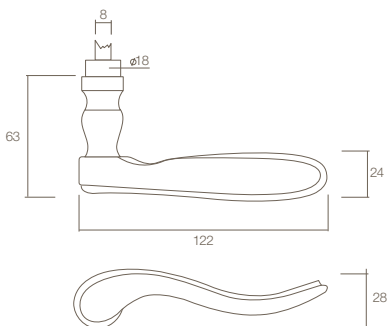

0021.027700

0021.027700A

0021.027700B

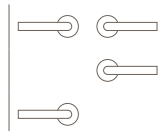

0277

0021.027700

Deurkruk Wing met rand. Oud grijs.

Door handle wing with edge. Old grey.

Türdrücker Wing mit Rand. Alt grau.

Béquille Wing avec bord. Vieux gris.



Accessoires

Accessories
Zubehör



0021.317304



0021.317316



0021.317317



0021.317360

8mm

0021.318560

8mm

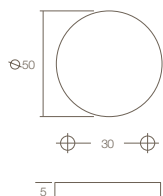

0021.370560

8mm

0021.370660

8mm verlengd



0021.370960

8mm

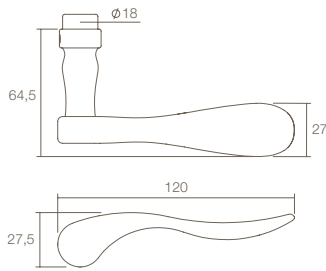

0021.027800



0021.027800A



0021.027800B

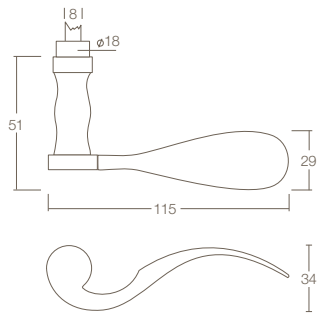

0021.029200



0021.029200A



0021.029200B

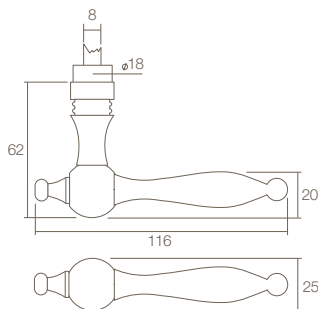

0021.031500



0021.031500A

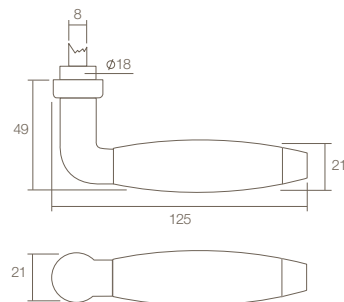

0021.042000



0021.042000A



0278

0021.027800

Deurkruk Wing. Oud grijs.



Door handle wing. Old grey.



Türdrücker Wing. Alt grau.

Béquille Wing. Vieux gris.



0278

0021.029200

Deurkruk Lepel. Oud grijs.



Door handle spoon. Old grey.

Türdrücker Löffel. Alt grau.

Béquille Lepel. Vieux gris.



0315

0021.031500

Deurkruk Peer. Oud grijs.



Door handle pear-shaped. Old grey.



Türdrücker Birne. Alt grau.

Béquille Poire. Vieux gris.



0420

0021.042000

Deurkruk Antonnet. Oud grijs/ebbenhout.



Door handle Antonnet. Old grey/ebony.



Türdrücker Antonnet. Alt grau/Ebenholz.

Béquille Antonnet. Vieux gris/bois d'ébène.

Accessoires

Accessories
Zubehör



0021.318604



0021.318616



0021.318617



0021.318660

8mm

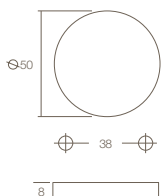

0021.370560

8mm

0021.370660

8mm verlengd



0021.370960

8mm

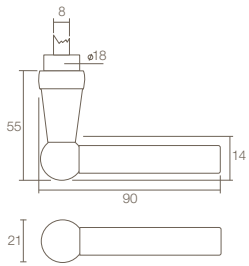

0021.032300



L+L

0021.032300A



L



0323

0021.032300

Deurkruk L/L-model. Oud grijs.



Door handle L/L model. Old grey.



Türdrücker L/L-Modell. Alt grau.

Béquille modèle L/L. Vieux gris.

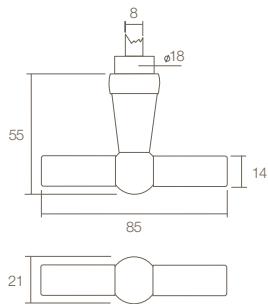

0021.032400



L+T

0021.032400A



T



0324

0021.032400

Deurkruk L/T-model. Oud grijs.



Door handle L/T model. Old grey.



Türdrücker L/T-Modell. Alt grau.

Béquille modèle L/T. Vieux gris.

Accessoires

Accessories
Zubehör



0021.318504



0021.318516



0021.318517



0021.318560

8mm

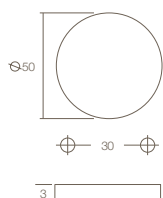

0021.370560



8mm

0021.370660

8mm verlengd



0021.370960



8mm



Oud grijs - Old grey - Alt grau - Vieux gris

Binnendeurbeslag - Rond / Ovaal

0021

Interior door hardware - Round / Oval

Innentürbeschläge - Rund / Oval

Garnitures de porte intérieure - Ronde / Ovale

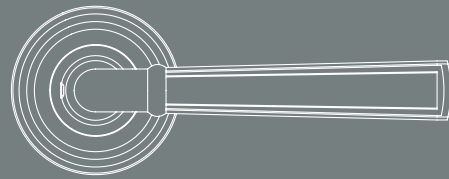

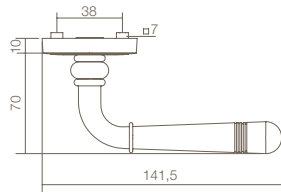
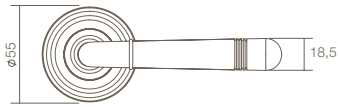

0021.172502



0021.172502A



0021.172502B

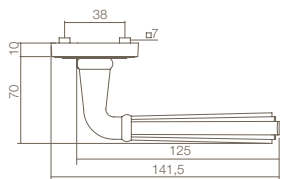
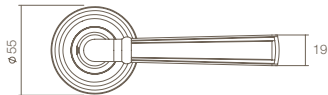

0021.173502



0021.173502A



0021.173502B



1725

0021.172502

Deurkruk Emily, vastdraaibaar met veer op ronde rozet. Nokken \varnothing 7mm. Oud grijs.



Springloaded Door handle Emily on round rose. Lugs \varnothing 7mm. Old grey plated.



Türdrücker Emily festdrehbar gelagert mit Feder auf runder Rosette. Stütznocken \varnothing 7mm. Alt grau.



Béquille Emily sertie sur rosace ronde avec ressort. Tenons \varnothing 7mm. Vieux gris.



1735

0021.173502

Deurkruk Bellevue, vastdraaibaar met veer op ronde rozet. Nokken \varnothing 7mm. Oud grijs.



Springloaded Door handle Bellevue on round rose. Lugs \varnothing 7mm. Old grey plated.



Türdrücker Bellevue festdrehbar gelagert mit Feder auf runder Rosette. Stütznocken \varnothing 7mm. Alt grau.



Béquille Bellevue sertie sur rosace ronde avec ressort. Tenons \varnothing 7mm. Vieux gris.

Accessoires

Accessories
Zubehör



0021.317816



0021.317817









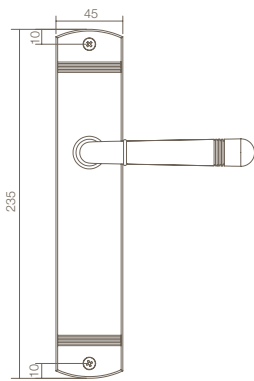
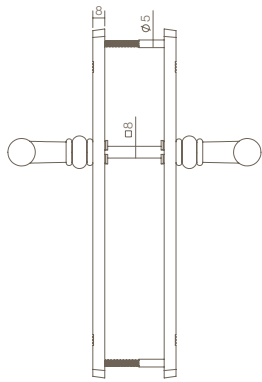







0021.317860

8mm





0021.170511			-----	
0021.170511A			-----	
0021.170511B			-----	
0021.170524				56mm
0021.170529				55mm
0021.170565				WC 63/8



1705

0021.170511

Deurkruk Emily vastdraaibaar met veer op langschild ovaal. Oud grijs.



Lever handle Emily on long plate oval. Old grey.



Türdrücker Emily auf Langschild oval. Alt grau.



Bequille Emily sertie sur plaque lonque longue ovale avec ressort. Vieux gris.

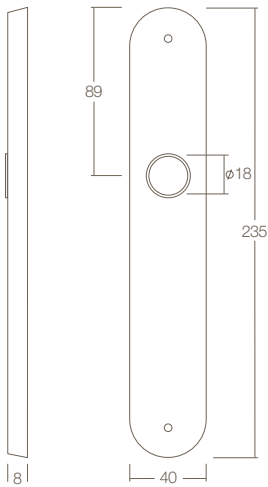

0021.253011			---	
0021.253024				56mm
0021.253026				72mm
0021.253029				55mm
0021.253036				72mm
0021.253049				92mm
0021.253065				WC 63/8
0021.253067				WC 72/8

Optie: Te combineren met deurkrukken op pagina 168-171.

Option: Combine with doorhandles from page 168-171.

Option: Zu kombinieren mit Türdrücker auf Seite 168-171.

Option: Une combinaison possible avec les béquilles de la page 168-171



2530

0021.253011

Langschild ovaal. Oud grijs.



Long plate oval. Old grey.



Langschild oval. Alt grau.



Plaque longue ovale. Vieux gris.

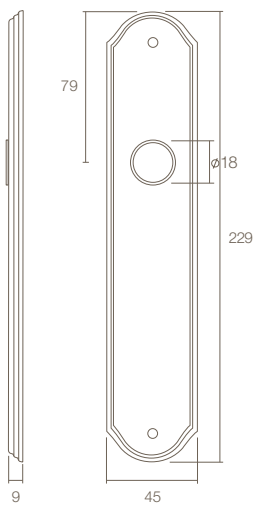

0021.254911			---	
0021.254924				56mm
0021.254926				72mm
0021.254928				110mm
0021.254929				55mm
0021.254936				72mm
0021.254962				WC 55/8
0021.254963				WC 57/5
0021.254965				WC 63/8
0021.254967				WC 72/8

Optie: Te combineren met deurkrukken op pagina 168-171.

Option: Combine with doorhandles from page 168-171.

Option: Zu kombinieren mit Türdrücker auf Seite 168-171.

Option: Une combinaison possible avec les béquilles de la page 168-171.



2549

0021.254911

Langschild 075. Oud grijs.



Long plate 075. Old grey.



Langschild 075. Alt grau.



Plaque longue modèle 075. Vieux gris.

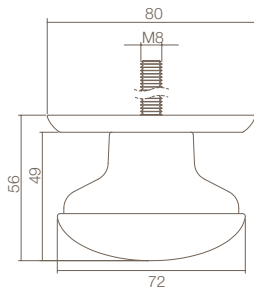

3930



0021.393033

Voordeurknop zwaar vast $\varnothing 72/80$ mm.
Doorgaande bevestiging M8. Oud grijs.



Front door knob heavy $\varnothing 72/80$. Old grey.

Knopf schwer $\varnothing 72/80$. Alt grau.

Bouton d'entrée fixe grande $\varnothing 72/80$ mm.
Fixation traversante M8. Vieux gris.

Accessoires

Accessories

Zubehör



0099.997470



Schroefdraad met rvs eindkap t.b.v. bevestiging voordeurknop.
304 RVS geborsteld.

Change spindle for front door knob, including a cover plate.
304 brushed stainless steel.

Gewindestift mit Hutmutter für Haustürknoopf.
Edelstahl 304 gebürstet.

Fixation traversante pour bouton d'entrée.
Inox mat AISI 304.



0021.397500

Afdekkplaatje tbv bout. Oud grijs.



Cover plate for bolt. Old grey.

Abdeckplättchen für Bolzen. Alt grau.

Cache boulon à vis. Vieux gris.

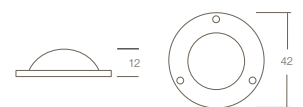

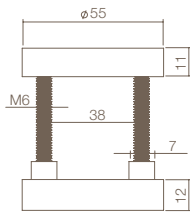
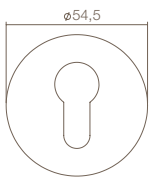

0021.375060

M6



3750

0021.375060

PC veiligheidsrozet rond verdekt. M6.
Oud grijs.



Security euro profile cylinder escutcheon.
With invisible fixing. M6. Old grey.



PZ Schutzrosette verdeckt. M6. Alt grau.



Entrée de cylindre de sécurité ronde.
Fixation invisible. M6. Vieux gris.

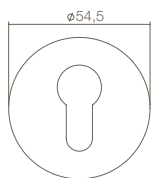

3751

0021.375130

Afdekrozet binnenzijde rond. Oud grijs.



Euro profile cylinder escutcheon round.
Old grey.







Schutzrosette rund. Alt grau.

Cache de rosace a l'interieur. Vieux gris.

Accessoires

Accessories
Zubehör



0099.990120	M6			58 - 64
0099.990122	M6			68 - 74
0099.990121	M6			78 - 84

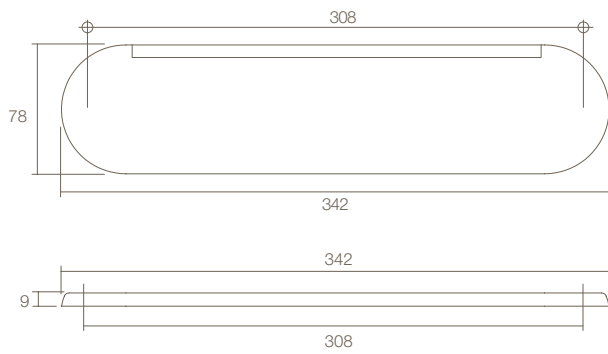

4015



0021.401500 Tochtwering ovaal met borstel en afdekklep.
Oud grijs.



Oval draught flap with brush and rain edge.
Old grey.



Zugklappe oval mit Bürstenleise und
Abdeckklappe verdeckt. Alt grau.

Plaque-a-lettres anti courants d'air, ovale,
avec clapet. Vieux gris.

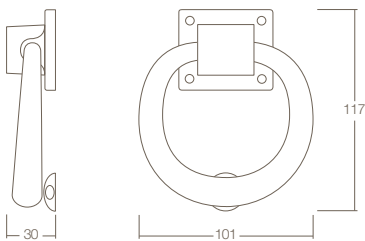
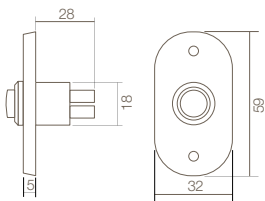
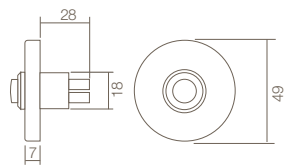
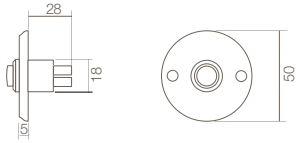

3990

0021.399023 Beldrukker rond. Opschroevend. Oud grijs.
 Round bell push. Screw mounting. Old grey.
 Klingelplatte rond. Schraubbar. Alt grau.
 Sonnette ronde. Fixation visible. Vieux gris.



3990

0021.399027 Beldrukker rond verdekt. Oud grijs.
 Round concealed bell push. Old grey.
 Klingelplatte rond verdeckt. Alt grau.
 Sonnette ronde. Fixation invisible.
 Vieux gris.



3992

0021.399025 Beldrukker ovaal. Opschroevend. Oud grijs.
 Bell push oval. Screw mounting. Old grey.
 Klingelknopf oval. Schraubbar. Alt grau.
 Sonnette ovale. Fixation visible. Vieux gris..



4035

0021.403500 Deurklopper rond. Oud grijs.
 Doorknocker round. Brass lacquered.
 Türklopper rund. Messing lackiert.
 Heurtoir de porte rond. Laiton verni.



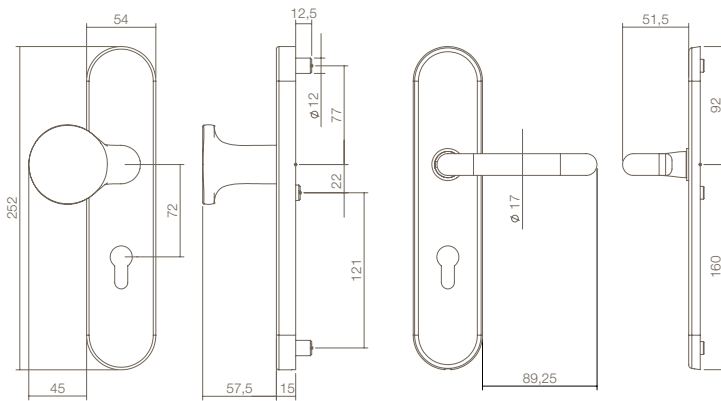

0021.384629		55mm
0021.384636		72mm
0021.384649		92mm



3846

0021.384636

PC veiligheidschilden greep/kruk los. Krukhals \varnothing 18mm. Links of rechts te monteren. Stift M14 x 8 x 75mm. Oud grijs.



Security plates pull/lever. Pull is reversible. Insert \varnothing 18mm. Spindle M14 x 8 x 75mm. Old grey.

Sicherheitsgarnitur Drücker/Griffplatte. Rechts/links verwendbar. Drücker Hals \varnothing 18mm. Stift M14 x 8 x 75mm. Alt grau.

Garnitures de sécurité. Tirant réversible. Béquille seule, cou de \varnothing 18mm, droite ou gauche. Tige M14 x 8 x 75mm. Vieux gris.

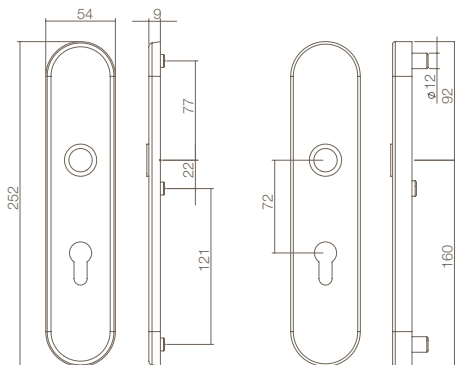

0021.381929		55mm
0021.381936		72mm
0021.381949		92mm

Optie: Te combineren met deurkrukken op pagina 168-171.

Option: Combine with doorhandles from page 168-171.

Option: Zu kombinieren mit Türdrücker auf Seite 168-171.

Option: Une combinaison possible avec les béquilles de la page 168-171.



3819

0021.381936

PC veiligheidsschilden doorgaand. Krukhals \varnothing 18mm. Oud grijs.



Security plates. Insert \varnothing 18mm. Old grey.

Schutzbeschlag durchgehend. Drücker Hals \varnothing 18mm. Alt grau.

Garnitures de sécurité. Béquille, cou de \varnothing 18mm. Vieux gris.

Accessoires

Accessories
Zubehör



0099.990120	M6	70mm	58 - 64
0099.990122	M6	80mm	68 - 74
0099.990121	M6	90mm	78 - 84



0099.975343	M14	\square 8x75mm	\leq 42
0099.975363	M14	\square 8x90mm	\leq 60
0099.975364	M14	\square 8x120mm	\leq 90



0099.975000	\square 8x105mm	\leq 42
0099.975001	\square 8x120mm	\leq 58
0099.975002	\square 8x150mm	\leq 90

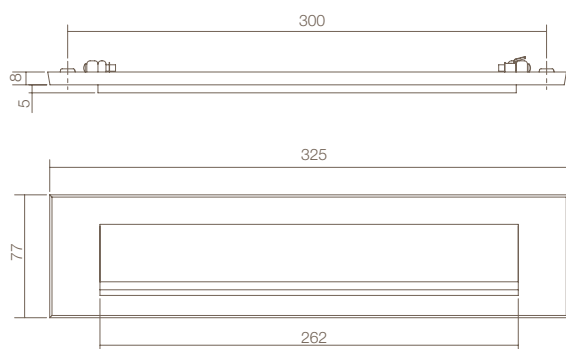

4000



0021.400001 Briefplaat rechthoekig met regenrand.
Klep half naar buitendraaiend. Oud grijs.



Letter plate square with rain edge. Opens
half outwards. Old grey.



Briefeinwurf rechteckig mit Tropfkante.
Klappe halb nach innen öffnend. Alt grau.

Plaque-à-lettres rectangulaire. S'ouvrant à
moitié vers l'extérieur. Vieux gris.

Oud grijs - Old grey - Alt grau - Vieux gris

Raambeslag - Raamkrukken en -sluitingen

0021

Window fittings - Window handles and closers

Fensterbeschläge - Fenstersicherung

Garnitures de fenêtres - Béquilles de fenêtre

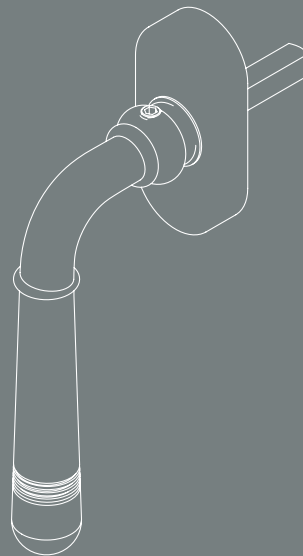

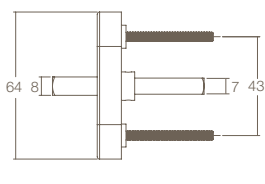
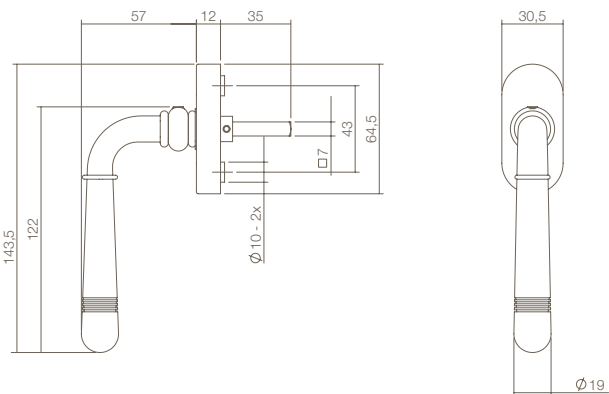
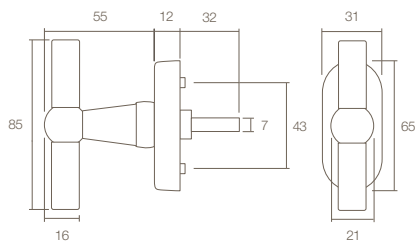
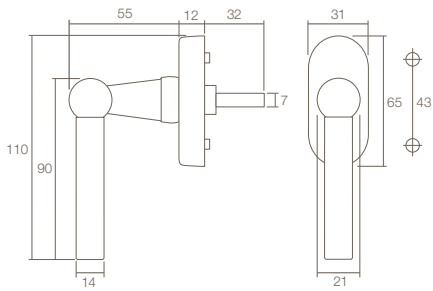

Optie: Te combineren met deurkrukken op pagina 168-171.

Option: Combine with doorhandles from page 168-171.

Option: Zu kombinieren mit Türdrücker auf Seite 168-171.

Option: Une combinaison possible avec les béquilles de la page 168-171.

6050



0021.605011 Raamkruk L-model. Oud grijs.



Window handle L model. Old grey.

Fenstergriff L-Modell. Alt grau.

Béquille de fenêtre modèle L. Vieux gris.

6050



0021.605013 Raamkruk T-model. Oud grijs.



Window handle T model. Old grey.

Fenstergriff T-Modell. Alt grau.

Béquille de fenêtre modèle T. Vieux gris.

6170



0021.617050 Raamkruk Emily. Oud grijs.



Window handle Emily. Old grey.

Fenstergriff Emily. Alt grau.

Béquille de fenêtre Emily. Vieux gris.

6050



0021.605000 Onderconstructie tbv raamkruk met hals ø18mm. Oud grijs.



Baseplate for window handle with a ø18mm insert. Old grey.

Unterkonstruktion für Fenstergriffe mit ø18mm Drückerhals. Alt grau.

Sous-construction pour bequille de fenetre. Cou ø18mm. Vieux gris.

Oud grijs - Old grey - Alt grau - Vieux gris

Toebehoren - Sierhulzen

0021

Accessories - Hinge covers

Zubehör - Übersteckhüls

Accessoires - Caches-paumelles



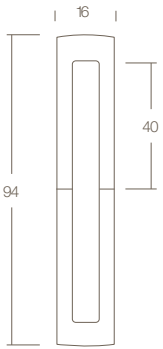

ø14mm

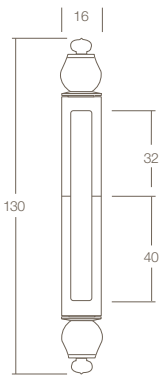

ø14mm



4540

0021.454000Sierhuls stomp 40/40mm voor paumelle
ø14mm. Oud grijs.

Decorative hinge cove 40/40mm. Old grey.

Übersteckhüls 40/40mm. Alt grau.

Cache-paumelles moderne 40/40mm
pour paumelles ø14mm Vieux gris.

4540

0021.454001Sierhuls met knop 32/40mm voor paumelle
ø14mm. Oud grijs.

Decorative hinge cover 32/40mm. Old grey.

Übersteckhüls 32/40mm. Alt grau.

Cache-paumelles avec bouton 32/40mm
pour paumelles ø14mm. Vieux gris.

Oud grijs - Old grey - Alt grau - Vieux gris

Toebehoren - Deurstoppers

0021

Accessories - Doorstops

Zubehör - Türstopper

Accessoires - Butoirs de porte

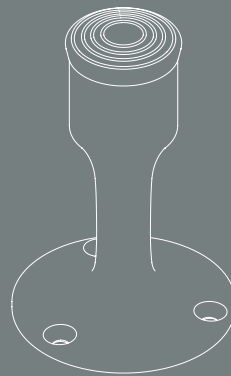

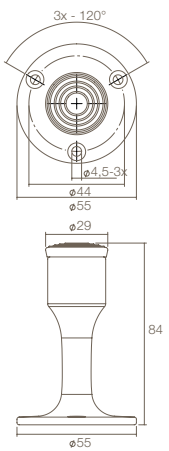
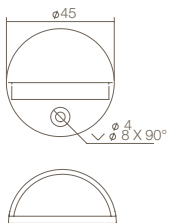
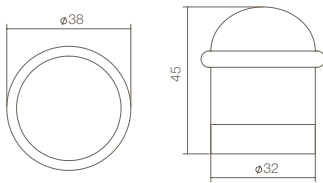

4420

0021.442000 Deurstop met ring. Oud grijs. Vloermontage
 Doorstop with ring. Old grey. Floor mounting.
 Türstopper mit Ring. Alt grau. Bodenmontage.
 Butoir de porte avec bague. Vieux gris.
 Pose au sol.



4420

0021.442020 Deurstop rond model. Oud grijs. Vloermontage
 Doorstop round model. Old grey. Floor mounting.
 Türstopper rundes Modell. Alt grau.
 Bodenmontage.
 Butoir de porte modèle rond. Vieux gris.
 Pose au sol.



4420

0021.442040 Deurstop recht model. Oud grijs. Wandmontage.
 Doorstop straight model Old grey.
 Wall mounting.
 Türstopper gerades Modell alt grau.
 Wandmontage.
 Butoir modèle droit pose mural vieux gris.
 Pose mural.



Oud grijs - Old grey - Alt grau - Vieux gris

Toebehoren - Deurgrepen

0021

Accessories - Pull handles

Zubehör - Stoßgriffe

Accessoires - Tirants

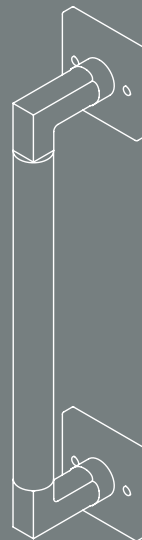

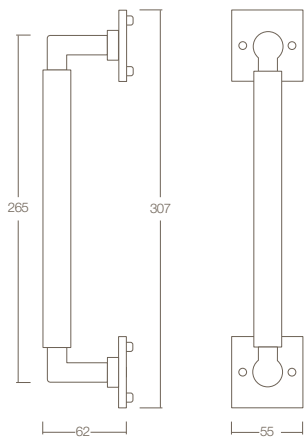
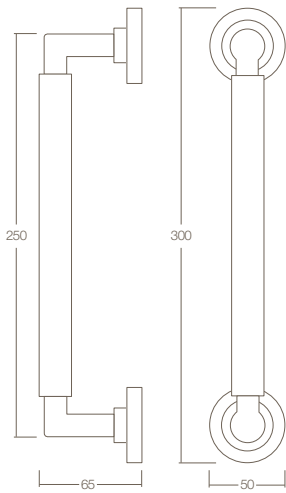

0021.426180



Deurgreep Bau-Stil 250mm op rond rozet.
Eenzijdige bevestiging. Oud grijs.

Pull handle Bau-Stil 250mm on square rose.
One side fixing. Old grey.

Stoßgriff Bau-Stil 250mm auf viereckige
Rosette. Einseitiger Befestigung. Alt grau.

Tirant modèle Bau-stil 250mm fixe sur
rosace ronde. Montage unilatérale.
Vieux gris.

4261



0021.426190



Deurgreep Bau-Stil 250mm op vierkant
rozet. Eenzijdige bevestiging. Oud grijs.

Pull handle Bau-Stil 250mm on round rose.
One side fixing. Old grey.

Stoßgriff Bau-Stil 250mm auf runder
Rosette. Einseitiger Befestigung.
Alt grau.

Tirant modèle Bau-stil 250mm fixe sur
rosace carrée. Montage unilatérale.
Vieux gris.

4261

Oud grijs - Old grey - Alt grau - Vieux gris

Toebehoren - Meubelgrepen en -knoppen

0021

Accessories - Furniture handles and knobs

Zubehör - Möbelgriffe und -knöpfe

Accessoires - Poignées de meubles

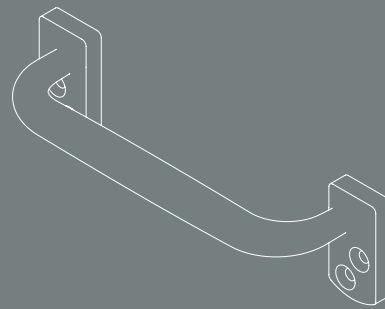

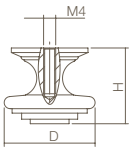

	D	H
0021.847740	25mm	20mm
0021.847741	30mm	25mm
0021.847742	35mm	27mm

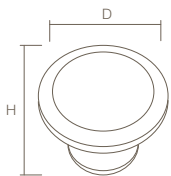
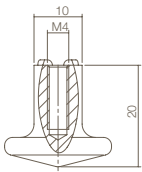

	D	H
0021.847920	25mm	20mm
0021.847921	30mm	23mm

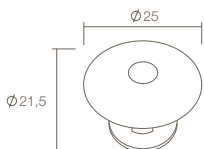

8477

0021.847740

Knop punt-cylindrisch. Oud grijs.



Knob pointed cylindrical. Old grey.

Knopf punktzylindrisch. Alt grau.

Bouton de meuble avec plusieurs rayures. Vieux gris.



8478

0021.847881

Knop vierkant kruis 26mm. Oud grijs.



Knob square cross 26 mm. Old grey.

Knopf Vierkant Kreuz 26 mm. Alt grau.

Bouton de meuble carrée croix 26mm. Vieux gris.



8477

0021.847920

Knop motief bloem. Oud grijs.



Knob flower motif. Old grey.

Knopf Blumenmotiv. Alt grau.

Bouton de meuble image fleur. Vieux gris.



8479

0021.847930

Knop rond/zon 25mm. Oud grijs.



Knob round/sun 25mm. Old grey.

Knopf rund/Sonne. Alt grau.

Bouton de meuble ronde/soleil 25mm. Vieux gris.

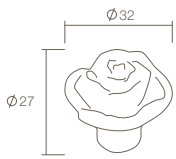

8479

- 0021.847950** Knop bloem. Oud grijs.
 Knob flower. Old grey.
 Knopf Blume. Alt grau.
 Bouton de meuble fleur. Vieux gris.

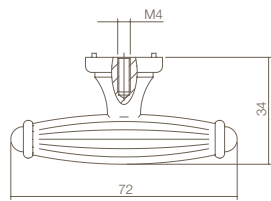

8479

- 0021.847970** Knop gerild. Oud grijs.
 Knob grooved. Old grey.
 Knopf gerillt. Alt grau.
 Bouton de meuble avec rainure. Vieux gris.

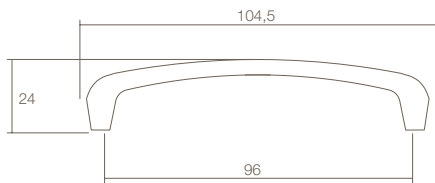

8756

- 0021.875601** Greep motief bloem. Oud grijs.
 Handle flower motif. Old grey.
 Griff Blumenmotiv. Alt grau.
 Poignée de meuble image fleur. Vieux gris.



	Ø	H
0021.875601	96mm	24mm
0021.875602	128mm	26mm

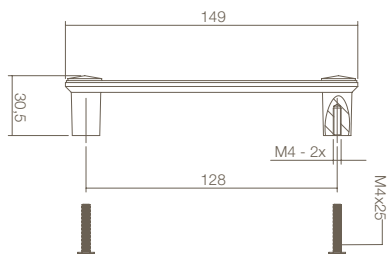

8756

- 0021.875610** Greep kruis. Oud grijs.
 Handle cross. Old grey.
 Griff Block. Alt grau.
 Poignée de meuble croix. Vieux gris.



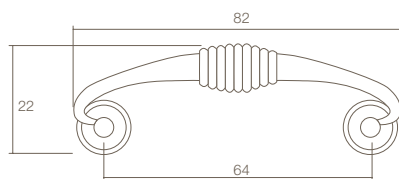

8756



0021.875630 Greep op rozet kabel 64mm. Oud grijs.



Handle on rose cable 64 mm. Old grey.

Griff auf Rosette Kabel 64mm. Alt grau.

Poignée de meuble avec rosace ronde
câble 64mm. Vieux gris.

Messing gebrüineerd - Brass antique

Messing brüniert - Laiton bronzé

Binnendeurbeslag - Losse krukken

0024

Interior door hardware - Door handles

Innentürbeschläge - Türdrucker

Garnitures de porte intérieure - Bequilles

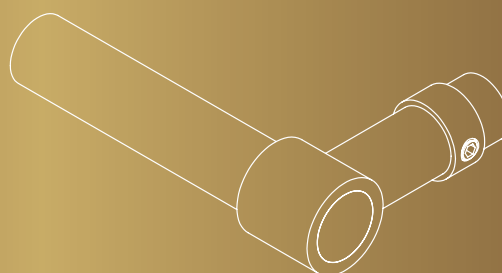

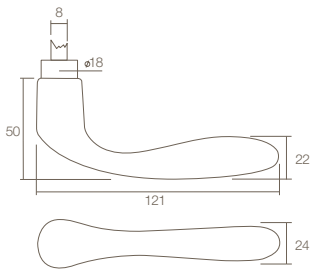

0024.020100

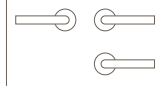

0024.020100A



0201

0024.020100

Deurkruk Banaan. Messing gebrüineerd.

Door handle Banaan. Antique brass.

Türdrücker Banaan. Messing brüniert.

Béquille Banane. Laiton bronzé.

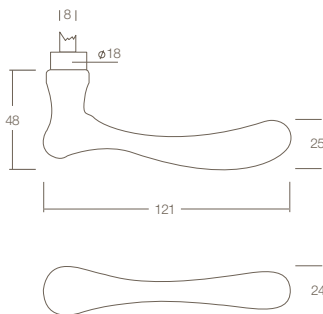

0024.020200

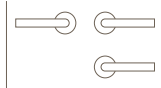

0024.020200A



0202

0024.020200

Deurkruk Neline. Messing gebrüineerd.

Door handle Neline. Antique brass.

Türdrücker Neline. Messing brüniert.

Béquille Neline. Laiton bronzé.

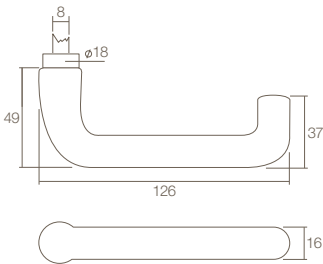

0024.023400

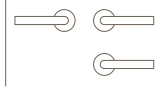

0024.023400A



0234

0024.023400

Deurkruk Rond. Messing gebrüineerd.

Door handle round. Antique brass.

Türdrücker rund. Messing brüniert.

Béquille modèle U. Laiton bronzé.

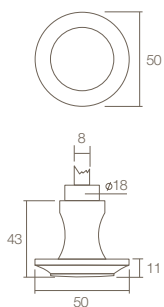

0024.025400

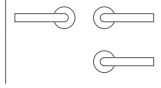

0024.025400A



0254

0024.025400

Knopkruk 50mm. Messing gebrüineerd.

Knob handle 50mm. Antique brass.

Knopfdrücker 50mm. Messing brüniert.

Bequille Bouton 50mm. Laiton bronzé.



Accessoires

Accessories
Zubehör



0024.317304



0024.317316



0024.317317

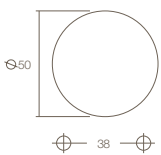

0024.318604



0024.318616



0024.318617



0024.318660



8mm



0024.370560

0024.370660



8mm

8mm verlengd



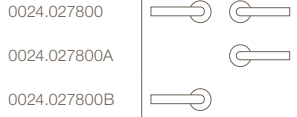
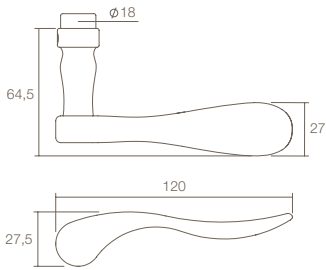

0278

0024.027800 Deurkruk Wing. Messing gebruneerd.

38 - 42 Door handle wing. Antique brass.

10 Tüdrücker Wing. Messing brüniert.

Béquille Wing. Laiton bronzé.

Accessoires
Accessories
Zubehör

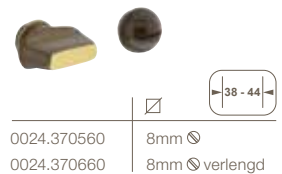
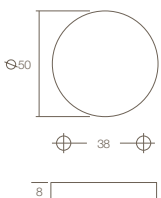



Messing gebrüineerd - Brass antique

Messing brüniert - Laiton bronzé

Binnendeurbeslag - Rond / Ovaal

0024









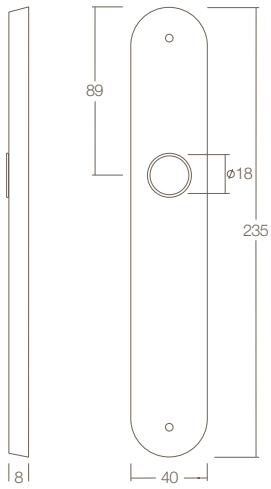

















Interior door hardware - Round / Oval

Innentürbeschläge - Rund / Oval

Garnitures de porte intérieure - Ronde / Ovale





0024.253011				
0024.253024				56mm
0024.253026				72mm
0024.253029				55mm
0024.253036				72mm
0024.253049				92mm
0024.254963				WC 57/5
0024.253065				WC 63/8
0024.253067				WC 72/8

Optie: Te combineren met deurkrukken op pagina 198-199.

Option: Combine with doorhandles from page 198-199.

Option: Zu kombinieren mit Türdrücker auf Seite 198-199.

Option: Une combinaison possible avec les béquilles de la 198-199.



2530

0024.253011

Langschild ovaal. Messing gebruneerd.



Long plate oval. Antique brass.









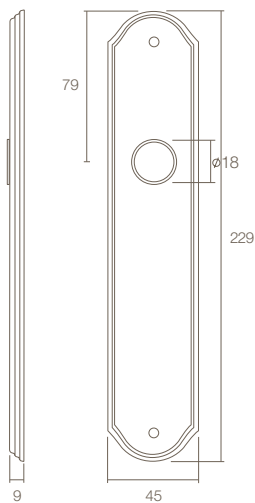

















Langschild oval. Messing brüniert.



Plaque longue ovale. Laiton bronze.



0024.254911				
0024.254924				56mm
0024.254926				72mm
0024.254929				55mm
0024.254936				72mm
0024.254963				WC 57/5
0024.254965				WC 63/8
0024.254967				WC 72/8

Optie: Te combineren met deurkrukken op pagina 198-199.

Option: Combine with doorhandles from page 198-199.

Option: Zu kombinieren mit Türdrücker auf Seite 198-199.

Option: Une combinaison possible avec les béquilles de la 198-199.



2549

0024.254911

Langschild 075. Messing gebruneerd.



Long plate 075. Antique brass.



Langschild 075. Messing brüniert.



Plaque longue modèle 075. Laiton bronzé.



Accessoires

Accessories
Zubehör



0024.315620

Messing gebrüineerd - Brass antique

Messing brüniert - Laiton bronzé

Buitendeurbeslag - Rond / Ovaal

0024

Exterior door hardware - Round / Oval

Haustürbeschläge - Rund / Oval

Garnitures de porte extérieure - Ronde / Ovale

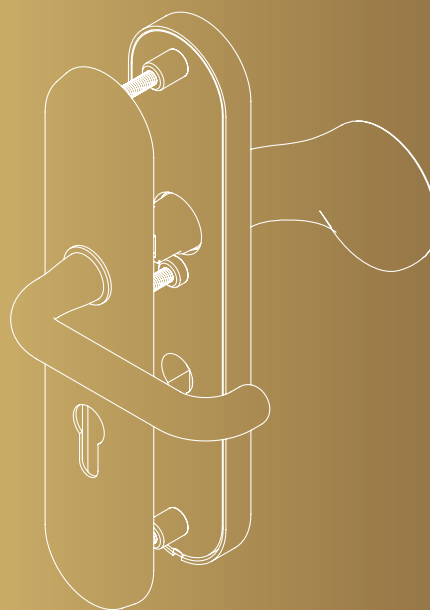

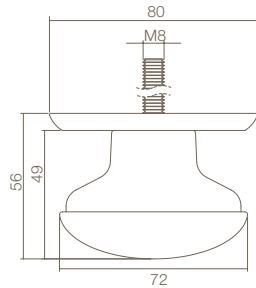
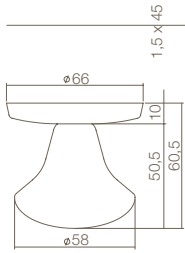

3930

0024.393030

Voordeurknop Paddenstoel vast $\phi 58/66$ mm.
Doorgaande bevestiging M8.
Messing gebruint.



Front door knob mushroom $\phi 58/66$ mm not turnable with bolt one side fixing M8. Antique brass.

Haustürknopf Pilz $\phi 58/66$ mm fest mit einseitiger Befestigung M8. Messing brüniert.

Bouton d'entree fixe Champignon $\phi 58/66$ mm. Fixation traversante M8. Laiton bronzé.



3930

0024.393033

Voordeurknop zwaar vast $\phi 72/80$ mm.
Doorgaande bevestiging M8.
Messing gebruint.



Front door knob heavy $\phi 72/80$ mm. Not turnable with bolt. One side fixing M8. Antique brass.

Haustürknopf schwer $\phi 72/80$ mm fest mit einseitiger Befestigung M8. Messing brüniert.

Bouton d'entree fixe grande $\phi 72/80$ mm. Fixation traversante M8. Laiton bronzé.

Accessoires

Accessories

Zubehör



0099.997470



Schroefdraad met rvs eindkap t.b.v. bevestiging voordeurknop.
304 RVS geborsteld.

Change spindle for front door knob, including a cover plate.
304 brushed stainless steel.

Gewindestift mit Hutmutter für Haustürknopf.
Edelstahl 304 gebürstet.

Fixation traversante pour bouton d'entrée.
Inox mat AISI 304.



0024.397500

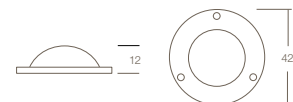

Afdekplaatje tbv bout voordeurknop.
Messing gebruint.

Cover plate for bout front door knob. Antique brass.

Abdeckplättchen für Bolzen Knopf. Messing brüniert.

Cache boulon à vis. Laiton bronzé.

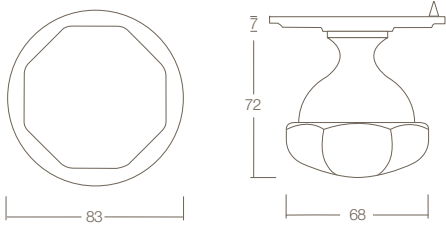

3930

0024.393045

Voordeurknop 8-kant. Doorgaande bevestiging M8. Messing gebruint.



Front door knob octagonal. Bolt through fixing M8. Antique brass.

Knopf achteckig mit durchgehender Befestigung M8. Messing brüniert.

Bouton d'entrée fixe 8-pans. Fixation traversante M8. Laiton bronzé.

Accessoires

Accessories
Zubehör



0099.997470



Schroefdraad met rvs eindkap t.b.v. bevestiging voordeurknop. 304 RVS geborsteld.

Change spindle for front door knob, including a cover plate. 304 brushed stainless steel.

Gewindestift mit Hutmutter für Haustürknoopf. Edelstahl 304 gebürstet.

Fixation traversante pour bouton d'entrée. Inox mat AISI 304.



0024.397500

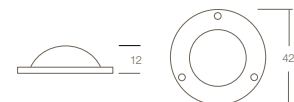

Afdekkplaatje tbv bout voordeurknop. Messing gebruint.

Cover plate for bout front door knob. Antique brass.

Abdeckplättchen für Bolzen Knopf. Messing brüniert.

Cache boulon à vis. Laiton bronzé.

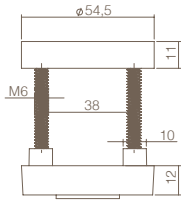

0024.375100

M6



3751

0024.375100

PC veiligheidsrozet rond verdekt met kerntrekbeveiliging. M6. Messing gebrüineerd.



Security euro profile cylinder escutcheon round with cylinder protection. With invisible fixing M6. Antique brass.

PZ Schutzrosette verdeckt Rund, mit Kernziehschutz. M6. Messing brüniert.

Entrée de cylindre de haute sécurité ronde avec cache anti-forage. Fixation invisible. M6. Laiton bronzé.

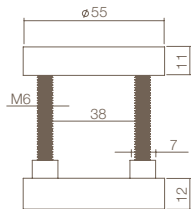
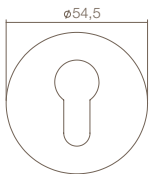

0024.375060

M6



3750

0024.375060

PC veiligheidsrozet rond verdekt. M6. Messing gebrüineerd.



Security euro profile cylinder escutcheon. With invisible fixing. M6. Antique brass.



PZ Schutzrosette verdeckt. M6. Messing brüniert.

Entrée de cylindre de sécurité ronde. Fixation invisible. M6. Laiton bronzé.

Accessoires

Accessories
Zubehör



			
0099.990120	M6	70mm	58 - 64
0099.990122	M6	80mm	68 - 74
0099.990121	M6	90mm	78 - 84

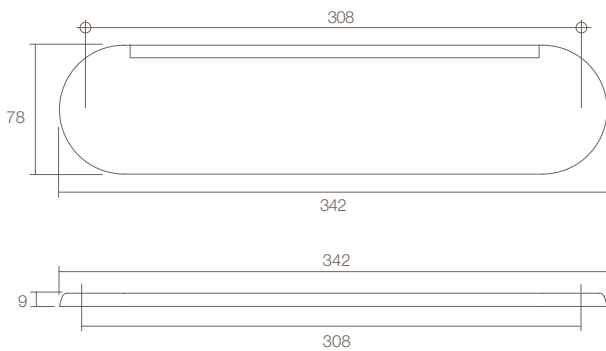
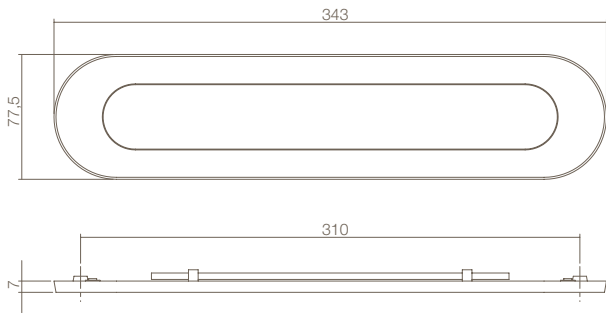

4000



0024.400005

Briefplaat ovaal met veer. Klep half naar binnendraaiend. Zowel horizontaal als verticaal te monteren. Messing gebruinteerd.



Springloaded oval letter plate. Opens half inwards. Can be mounted both horizontally and vertically. Antique brass.

Briefeinwurf oval mit Feder. Klappe halb nach innen öffnend. Kann sowohl horizontal und vertikal montiert werden. Messing brüniert.

Plaque-a-lettres ovale avec ressort. Pose horizontal ou vertical. S'ouvrant à moitié vers l'intérieur. Laiton bronzé.

4015



0024.401500

Tochtwering ovaal met borstel en afdekklep. Messing gebruinteerd.



Oval draught flap with brush and rain edge. Antique brass.

Zugklappe oval mit Bürstenleise und Abdeckklappe verdeckt. Messing brüniert.

Plaque-a-lettres anti courants d'air, ovale, avec clapet. Laiton bronzé.

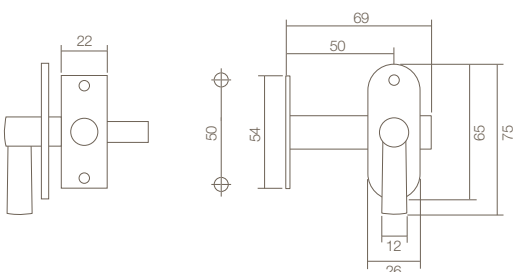
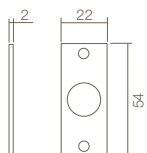
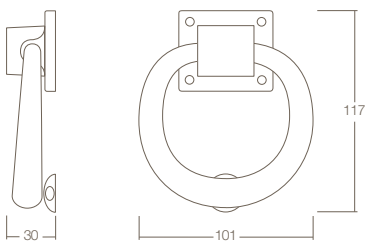
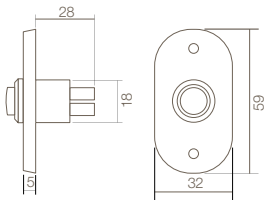
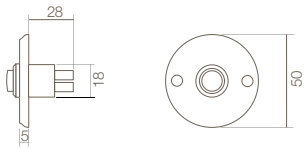

3990

0024.399023

Beldrukker rond. Opschroevend.
Messing gebruneerd.



Round bell push. Screw mounting.
Antique brass.

Klingelplatte rond. Schraubbar.
Messing brüniert.

Sonnette ronde. Fixation visible.
Laiton bronzé.



3992

0024.399025

Beldrukker ovaal. Opschroevend.
Messing gebruneerd.



Oval bell push. Screw mounting.
Antique brass.

Klingelplatte ovaal. Schraubbar.
Messing brüniert.

Sonnette ovale. Fixation visible.
Laiton bronzé.



4035

0024.403500

Deurklopper rond. Messing gebruneerd.



Doorknocker round. Antique brass.

Türklopper rond. Messing brüniert.

Heurtoir de porte rond. Laiton bronzé.

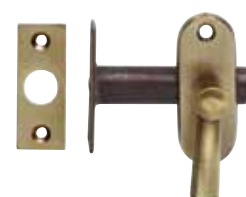

4055

0024.405525

Insteekgrendel. Messing gebruneerd.



Lock insert. Antique brass.

Einsteckschloss. Messing brüniert.

Verrou à larder. Laiton bronzé.

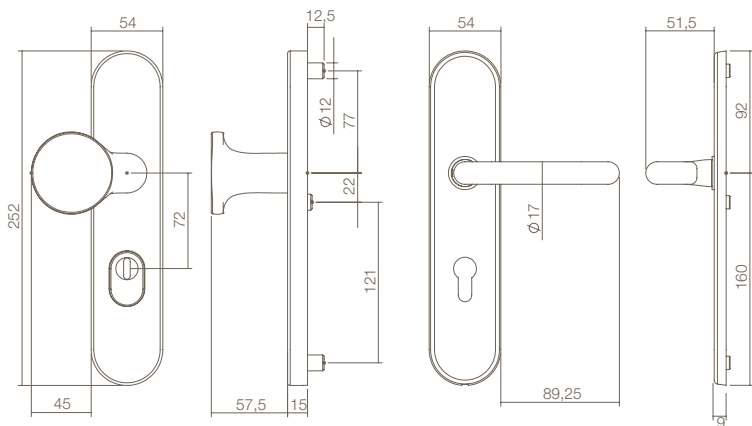

0024.382029		55mm
0024.382036		72mm
0024.382049		92mm



3820

0024.382036

Veiligheidsschilden met kerntrekbeveiliging greep/kruk los. Krukhals \varnothing 18mm. Links of rechts te monteren. Stift M14 x 8 x 75mm. Messing gebruneerd.



Security plates pull/lever with cylinder protection. Pull is reversible. Insert \varnothing 18mm. Spindle M14 x 8 x 75mm. Antique brass.

Sicherheitsgarnitur Drücker/Griffplatte mit Kernziehschutz. Rechts/links verwendbar. Drücker Hals \varnothing 18mm. Stift M14 x 8 x 75mm. Messing bruniert

Garnitures de sécurité avec cache anti-forage et tirant fixe. Tirant réversible. Béquille seule, cou de \varnothing 18mm, droite ou gauche. Tige M14 x 8 x 75mm. Laiton bronze.

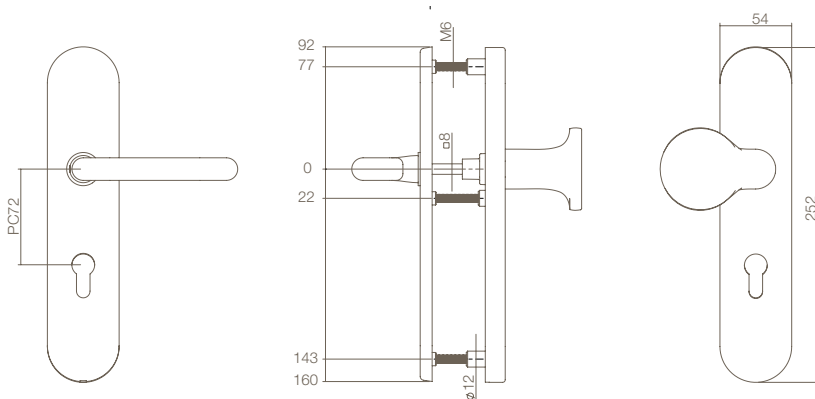

0024.384629		55mm
0024.384636		72mm
0024.384649		92mm



3846

0024.384636

PC veiligheidsschilden greep/kruk los. Krukhals \varnothing 18mm. Links of rechts te monteren. Stift M14 x 8 x 75mm. Messing gebruneerd.



Security plates pull/lever. Pull is reversible. Insert \varnothing 18mm. Spindle M14 x 8 x 75mm. Antique brass.

Sicherheitsgarnitur Drücker/Griffplatte. Rechts/links verwendbar. Drücker Hals \varnothing 18mm. Stift M14 x 8 x 75mm. Messing buniert.

Garnitures de sécurité. Tirant réversible. Béquille seule, cou de \varnothing 18mm, droite ou gauche. Tige M14 x 8 x 75mm. Laiton bronzé.

Accessoires

Accessories
Zubehör



0099.990120	M6	70mm	58 - 64	0099.975343	M14	\square 8x75mm	\leq 42
0099.990122	M6	80mm	68 - 74	0099.975363	M14	\square 8x90mm	\leq 60
0099.990121	M6	90mm	78 - 84	0099.975364	M14	\square 8x120mm	\leq 90

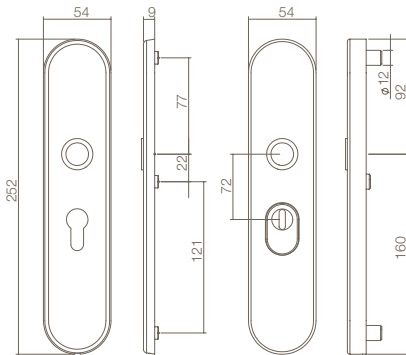

0024.382129		55mm
0024.382136		72mm
0024.382149		92mm

- Optie:** Te combineren met deurkrukken op pagina 198-199.
- Option:** Combine with doorhandles from page 198-199.
- Option:** Zu kombinieren mit Türdrücker auf Seite 198-199.
- Option:** Une combinaison possible avec les béquilles de la page 198-199.

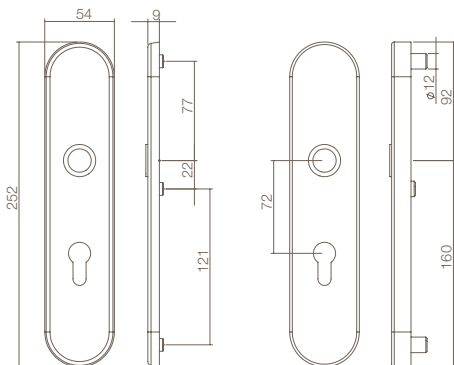

0024.381929		55mm
0024.381936		72mm
0024.381949		92mm

- Optie:** Te combineren met deurkrukken op pagina 198-199.
- Option:** Combine with doorhandles from page 198-199.
- Option:** Zu kombinieren mit Türdrücker auf Seite 198-199.
- Option:** Une combinaison possible avec les béquilles de la page 198-199.

3821



0024.382136

PC veiligheidsschilden doorgaand met kerntrekbeveiliging. Krukhals ø18mm. Messing gebruint.



Security plates with cylinder protection. Insert ø18mm. Antique brass.

Schutzbeschlag mit Kernziehschutz. Drücker Hals ø18mm. Messing brüniert.

Garnitures de sécurité avec cache anti-forage. Béquille, cou de ø18 mm. Laiton bronzé.

3819



0024.381936

PC veiligheidsschilden doorgaand. Krukhals ø18mm. Messing gebruint.



Security plates. Insert ø18mm. Antique brass.

Schutzbeschlag durchgehend. Drücker Hals ø18mm. Messing brüniert.

Garnitures de sécurité. Béquille, cou de ø18mm. Laiton bronzé.

Accessoires

Accessories
Zubehör



0099.990120	M6	70mm	58 - 64
0099.990122	M6	80mm	68 - 74
0099.990121	M6	90mm	78 - 84



0099.975000	□ 8x105mm	≤ 42
0099.975001	□ 8x120mm	≤ 58
0099.975002	□ 8x150mm	≤ 9

Messing gebrüineerd - Brass antique

Messing brüniert - Laiton bronzé

Buitendeurbeslag - Vierkant

0024

Exterior door hardware - Square

Haustürbeschläge - Eckig

Garnitures de porte extérieure - Carrée

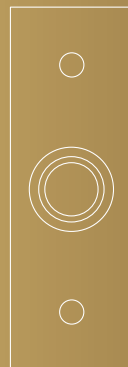

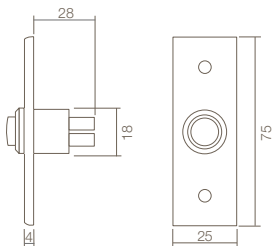

3990

0024.399033

Beldrukker rechthoekig smal. Opschroevend.
Messing gebruinteerd.



Square bell push small. Screw mounting.
Messing brûniert.

Klingelplatte eckig schmal. Schraubbar.
Messing brûniert.

Sonnette rectangulaire étroite. Fixation visible.
Laiton bronzé.

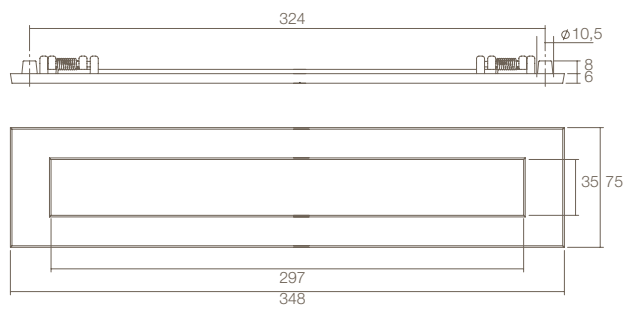
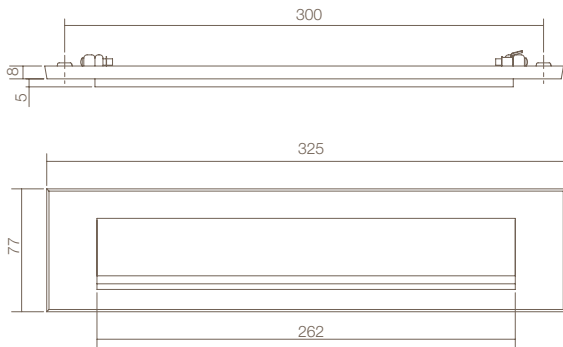

4000



0024.400001 Briefplaat rechthoekig met regenrand. Klep half naar buitendraaiend. Messing gebrüineerd.



Letter plate square with rain edge. Opens half outwards. Antique brass.



Briefeinwurf rechteckig mit Tropfkante. Klappe halb nach aussen öffnend. Messing brüniert.

Plaque-à-lettres rectangulaire. S'ouvrant à moitié vers l'extérieur. Laiton bronzé.

4000



0024.400004 Briefplaat rechthoekig met veer. Klep half naar binnendraaiend. Zowel horizontaal als verticaal te monteren. Messing gebrüineerd.



Square springloaded letter plate. Opens half inwards. Can be mounted both horizontally and vertically. Antique brass.



Briefeinwurf rechteckig. Mit feder. Klappe halb nach innen öffnend. Kann sowohl horizontal und vertikal montiert werden. Messing brüniert.

Plaque-à-lettres rectangulaire avec ressort. Pose horizontal ou vertical. S'ouvrant à moitié vers l'intérieur. Laiton bronzé.



Messing gebrüineerd - Brass antique

Messing brüniert - Laiton bronzé

Buitendeurbeslag - Huiscijfers

0024

Exterior door hardware - House numbers

Haustürbeschläge - Hausnummern

Garnitures de portes extérieure - Numéros de maison



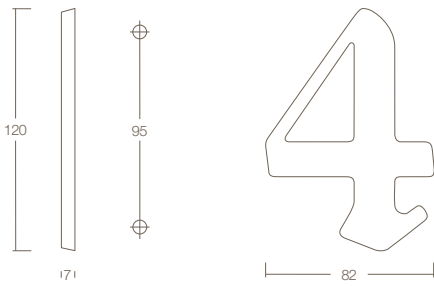

0024.402010	0	120mm
0024.402011	1	120mm
0024.402012	2	120mm
0024.402013	3	120mm
0024.402014	4	120mm
0024.402015	5	120mm
0024.402016	6	120mm
0024.402017	7	120mm
0024.402018	8	120mm
0024.402019	9	120mm



4020

0024.40201x

Huiscijfer gotisch. Messing gebruint.



House number gothic. Including mounting material. Antique brass.

Hausnummer gotisch inkl. Befestigung. Messing brüniert.

Numero de maison gothique. Fixation fournie. Laiton bronzé.

0 1 2 3 4
5 6 7 8 9

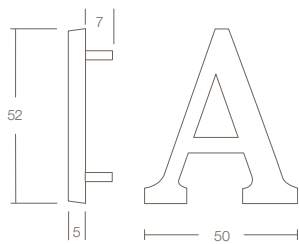

0024.402501	A	50mm
0024.402502	B	50mm
0024.402503	C	50mm



4025

0024.40250x

Huisletter. Inclusief bevestiging. Messing gebruint.



House letter. Including mounting material. Antique brass.

Hausnummer inkl. Befestigung. Messing brüniert.

Lettre de maison. Fixation fournie. Laiton bronzé.

A B C

Messing gebrüineerd - Brass antique

Messing brüniert - Laiton bronzé

Raambeslag - Raamsluitingen

0024

Window fittings - Window closers

Fensterbeschläge - Fenstersicherung

Garnitures de fenêtres - Béquilles de fenêtre

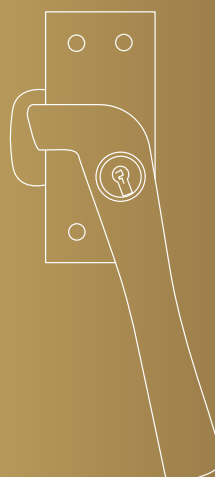

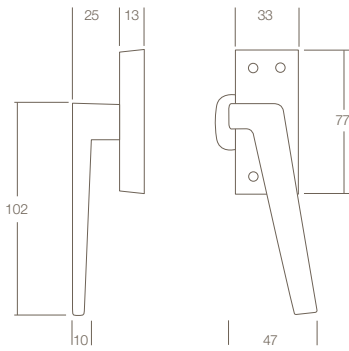

0024.561510A

0024.561510B

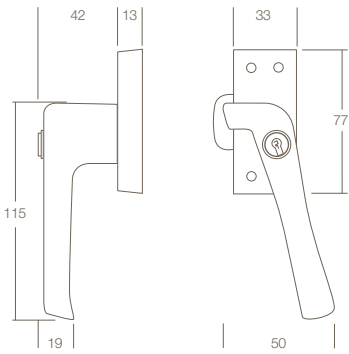
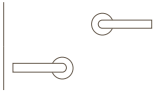

0024.561530A

0024.561530B

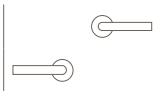

5615

0024.561510A Raamsluiting met nok.
Messing gebruieneerd.



Window closer with lug.
Antique brass.

Fenstersicherung mit Stütznock.
Messing brüniert.

Bequille de fenetre en applique.
Laitin bronzé.



5615

0024.561530A Afsluitbare raamsluiting met nok.
Messing gebruieneerd.



Lockable window closer with lug.
Antique brass.

Fenstersicherung. Abschließbar mit
Stütznock. Messing brüniert.

Bequille de fenetre en applique
verrouillable, droite. Laiton bronzé.

Accessoires

Accessories
Zubehör



0024.561500

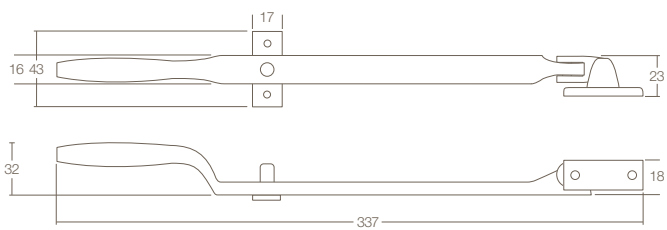

5615



0024.561580

Raamuitzetter Dudok met stelpen.
Messing gebrüineerd.



Window casement stay. With casement stay
pin. Antique brass.

Fensteraufsteller mit Stellstift.
Messing brüniert.

Entrebâilleur Dudok avec cheville de
positionnement. Laiton bronzé.

Accessoires

Accessories
Zubehör



0024.561589



Messing gebrüineerd - Brass antique

Messing brüniert - Laiton bronzé

Toebehoren - Espagnoletten

0024

Accessories - Espagnolette

Zubehör - Espagnolette

Accessoires - Espagnolette



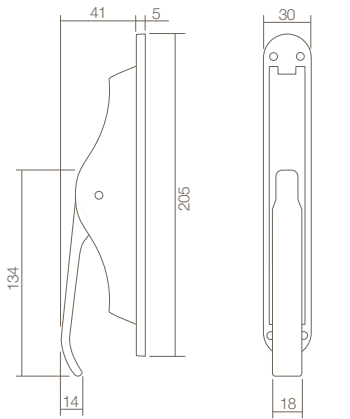

5620



0024.562030

Pomp-espagnolet. Messing gebruieneerd.



Pump espagnolet. Antique brass.

Pump-Espagnolet. Messing brüniert.

Espagnolette à levier. Laiton bronzé.

Accessoires

Accessories
Zubehör



0024.562000



0024.562001



0024.562002

0024.562004
2 x 125cm

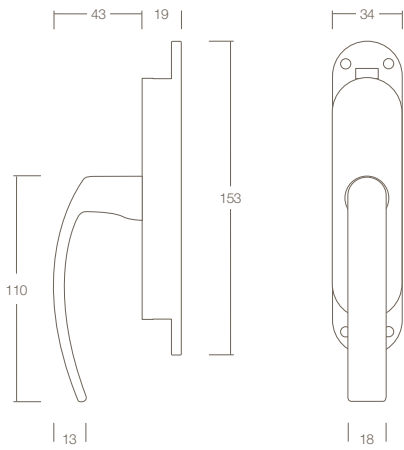

0024.562050A

0024.562050B

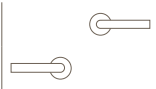

5620

0024.562050A Kruk-espagnolet. Messing gebruneerd.

Handle espagnolet. Antique brass.

Klinken-Espagnolet. Messing brüniert.

Crémone béquille. Laiton bronzé.

Accessoires

Accessories
Zubehör



0024.562000



0024.562001



0024.562002

0024.562007
2 x 125cm

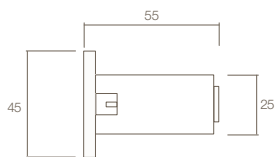
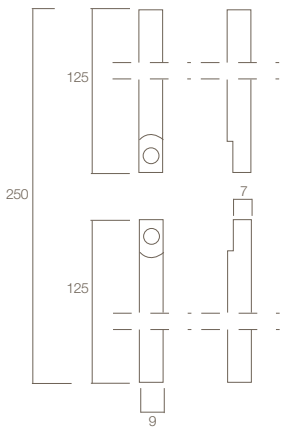
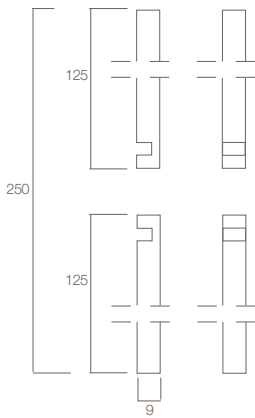

Accessoires

Accessories
Zubehör



0024.562000



0024.562001

5620



0024.562004

Stagenset tbv pomp-espagnolet. 2 x 125cm.
Messing gebrüineerd.



Rods set for espagnolette. 2 x 125cm.
Antique brass.

Stagen set für Espagnolette. 2 x 125cm.
Messing brüniert.

Set tringles pour espagnolette à levier.
2 x 125cm. Laiton bronzé.

5620



0024.562007

Stagenset tbv kruk-espagnolet. 2 x 125cm.
Messing gebrüineerd.



Rods set for espagnolette. 2 x 125cm.
Antique brass.

Stagen set für Espagnolette. 2 x 125cm.
Messing brüniert.

Set tringles pour espagnolette à levier.
2 x 125cm. Laiton bronzé.

5620



0024.562002

Espagnoletslot. Messing gebrüineerd.



Espagnolet lock. Antique brass.

Espagnoletschloss. Messing brüniert.

Verou pour espagnolette. Laiton bronzé.

Messing gebrüineerd - Brass antique

Messing brüniert - Laiton bronzé

Toebehoren - Meubelgrepen en -knoppen

0024

Accessories - Furniture handles and knobs

Zubehör - Möbelgriffe und -knopfen

Accessoires - Poignées de meuble



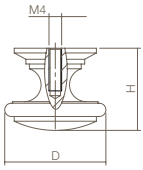

0024.847773

D	H
32mm	26mm



8477

0024.847773

Knop afgerond 32mm. Messing gebruineerd.



Knob rounded 32 mm. Antique brass.

Knopf abgerundet 32mm. Messing brüniert.

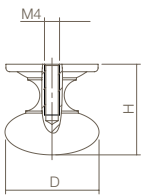
Bouton de meuble arrondi 32mm.
Laiton bronzé.

0024.847822

D	H
30mm	28,5mm



8478

0024.847822

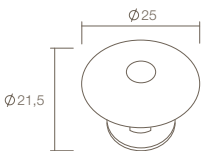
Knop paddenstoel met achterplaat 30mm.
Messing gebruineerd.Knob mushroom with back plate 30 mm.
Antique brass.Knopf Pilz mit Hinterplatte 30 mm.
Messing brüniert.Bouton de meuble Champignon avec
rosace fixe 30mm. Laiton bronzé.

8479

0024.847930

Knop rond/zon gebruineerd.



Knob round/sun antique brass.

Knopf rund/Sonne brüniert.

Bouton de meuble ronde/soleil laiton bronzé.

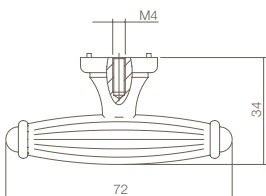

8479

0024.847970

Knop gerild gebruineerd.



Knob grooved antique brass.

Knopf gerillt brüniert.

Bouton de meuble rainure laiton bronzé.

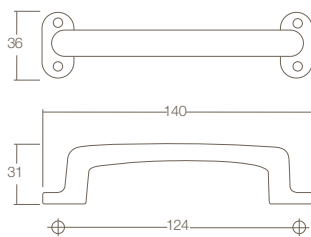
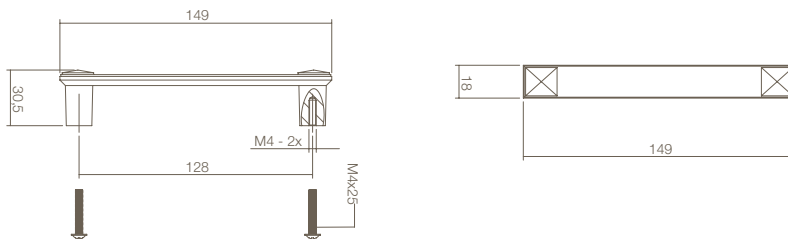
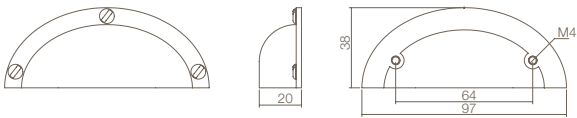
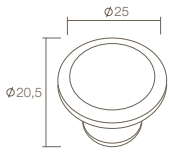

8480

0024.848020 Knop rond/kabel 25mm.
Messing gebruneerd.



Knob round/cable 25 mm. Antique brass.
Knopf rund/Kabel 25mm. Messing brüniert.

Bouton de meuble ronde/câble 25mm.
Laiton bronzé.



8752

0024.875250 Komgreep 64/97mm. Messing gebruneerd.



Recessed handle 64/97 mm. Antique brass.
Schalengriff 64/97 mm. Messing brüniert.

Poignée Coquille 64/97mm.
Laiton bronzé.



8756

0024.875611 Greep kruis. Messing gebruneerd.



Handle cross. Antique brass.
Griff Kreuz. Messing brüniert.

Poignée de meuble avec croix.
Laiton bronzé.



5615

0024.561591 Handgreep 777. Messing gebruneerd.



Furniture handle 777. Antique brass.
Handgriff 777. Messing brüniert.

Poignée 777. Laiton bronzé.



Messing gebrüineerd - Brass antique

Messing brüniert - Laiton bronzé

Toebehoren - Garderobe

0024

Accessories - Coat rack

Zubehör - Garderoben

Accessoires - Porte-manteaux





	D	H
0024.692502	35mm	27mm
0024.692503	42mm	32mm
0024.692504	50mm	38mm



6925

0024.692502

Haak. Messing gebruieneerd.



Hook. Antique brass.

Haken. Messing brüniert.

Crochet. Laiton bronzé.

Messing titanium - Brass titanium
Messing Titanium - Titane laiton poli

Binnendeurbeslag - Rond / Ovaal

0050

Interior door hardware - Round / Oval

Innentürbeschläge - Rund / Oval

Garnitures de porte intérieure - Ronde / Ovale



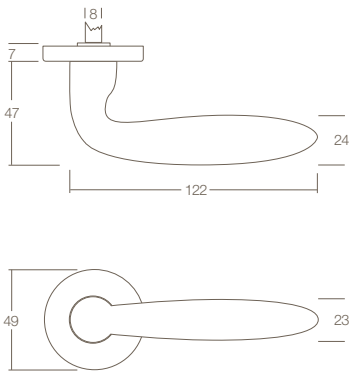

0050.019902

0050.019902A

0050.019902B

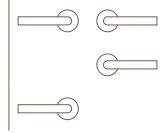

0199

0050.019902

Deurkruk Sigaar vastdraaibaar met veer op ronde rozet. Messing titanium.



Springloaded door handle Sigar on round rose. Brass titanium.



Türdrücker Sigar festdrehbar gelagert mit Feder auf runder Rosette. Messing Titanium.



Béquille Cigare sertie sur rosace ronde avec ressort. Titane laiton poli.

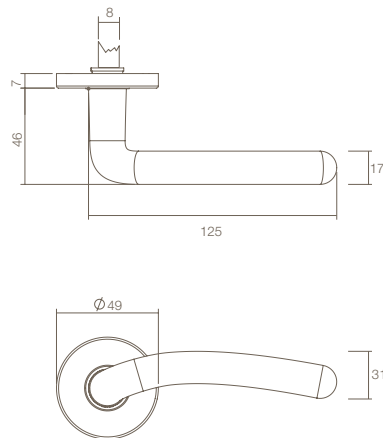

0050.029502

0050.029502A

0050.029502B

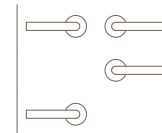

0295

0050.029502

Deurkruk Alice vastdraaibaar met veer op rond rozet. Messing titanium.



Springloaded door handle Alice on round rose. Brass titanium.



Türdrücker Alice festdrehbar gelagert mit Feder auf runder Rosette. Messing Titanium.



Béquille Alice sertie sur rosace ronde avec ressort. Titane laiton poli.

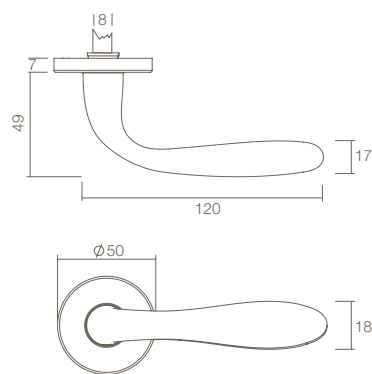

0050.045202

0050.045202A

0050.045202B

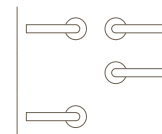

0452

0050.045202

Deurkruk Mercurius vastdraaibaar met veer op rond rozet. Messing titanium.



Springloaded door handle Mercurius on round rose. Brass titanium.



Türdrücker Mercurius festdrehbar gelagert mit Feder auf runder Rosette. Messing Titanium.



Béquille Mercurius sertie sur rosace ronde avec ressort. Titane laiton poli.

Accessoires Accessories Zubehör



0050.322416



0050.322417

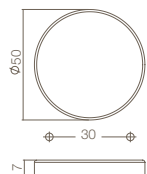

0050.322460

 8mm \varnothing

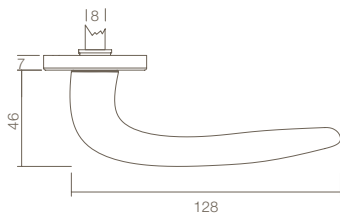

0050.045302



0050.045302A



0050.045302B

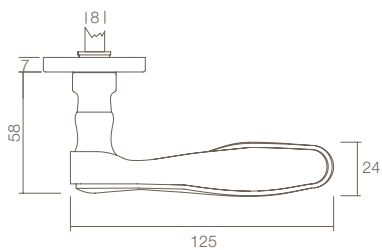
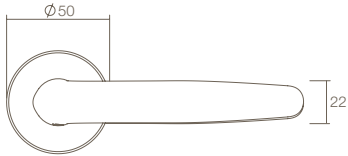

0050.045402



0050.045402A



0050.045402B

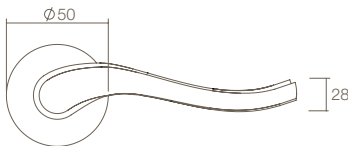

0452

**0050.045302**

Deurkruk Ellips vastdraaibaar met veer op rond rozet. Messing titanium.



Springloaded door handle Ellips on round rose. Brass titanium.



Türdrücker Ellips festdrehbar gelagert mit Feder auf runder Rosette. Messing Titanium.



Béquille Ellipse sertie sur rosace ronde avec ressort. Titane laiton poli.

0452

**0050.045402**

Deurkruk Wing met rand vastdraaibaar met veer op rond rozet. Messing titanium.



Springloaded door handle Wing with edge on round rose. Brass titanium.



Türdrücker Wing mit Rand festdrehbar gelagert mit Feder auf runder Rosette. Messing Titanium.



Bequille Wing avec bord sertie sur rosace ronde avec ressort. Titane laiton poli.

Accessoires

Accessories
Zubehör

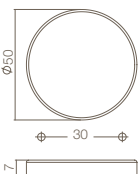

0050.322416



0050.322417



0050.322460

 8mm \varnothing



WELCOME



Messing titanium - Brass titanium
Messing Titanium - Laiton démonte-pneu

Buitendeurbeslag - Rond / Ovaal

0050

Exterior door hardware - Round / Oval

Haustürbeschläge - Rund / Oval

Garnitures de porte extérieure - Ronde / Ovale

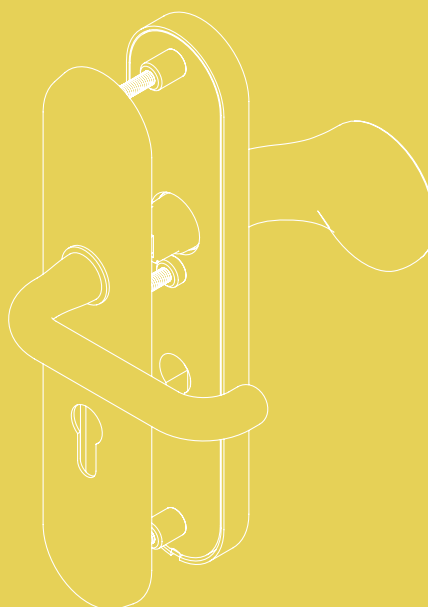

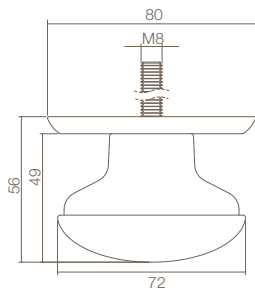

3930

0050.393033

Voordeurknop zwaar vast $\varnothing 72/80$ mm.
Doorgaande bevestiging M8.
Messing titanium.



Front door knob heavy $\varnothing 72/80$ mm.
Not turnable with bolt. One side
fixing M8. Brass titanium.

Haustürknoopf schwer $\varnothing 72/80$ mm fest
mit einseitiger Befestigung M8.
Messing Titanium.

Bouton d'entrée fixe grande $\varnothing 72/80$ mm.
Fixation traversante M8. Titane laiton poli.

Accessoires

Accessories

Zubehör

**0099.997470**

Schroefdraad met rvs eindkap t.b.v. bevestiging voordeurknop.
304 RVS geborsteld.

Change spindle for front door knob, including a cover plate.
304 brushed stainless steel.

Gewindesttift mit Hutmutter für Haustürknoopf.
Edelstahl 304 gebürstet.

Fixation traversante pour bouton d'entrée.
Inox mat AISI 304.

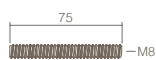
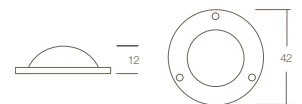
**0013.397500**

Afdeekplaatje t.b.v. bout. Messing gelakt.

Bolt cover plate. Brass titanium.

Abdeckplatte für Bolzen. Messing Titanium.

Ce cache boulon couvre la vis du bouton.
Laiton verni.

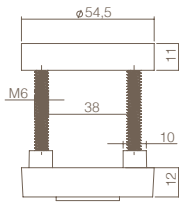
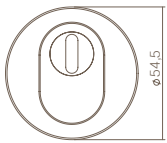

0050.375100

M6

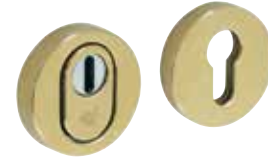

3751

0050.375100

PC veiligheidsrozet rond verdekt met kerntrekbeveiliging. M6. Messing titanium.



Security euro profile cylinder escutcheon round with cylinder protection.



With invisible fixing M6. Brass titanium.



PZ Schutzrosette verdeckt Rund, mit Kernziehschutz. M6. Messing Titanium.



Entrée de cylindre de haute sécurité ronde avec cache anti-forage. Fixation invisible. M6. Titane laiton poli.

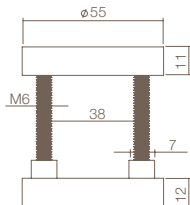
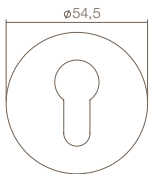

0050.375060

M6



3750

0050.375060

PC veiligheidsrozet rond verdekt. M6. Messing titanium.



Security euro profile cylinder escutcheon. With invisible fixing. M6. Brass titanium.



PZ Schutzrosette verdeckt. M6. Messing Titanium.



Entrée de cylindre de sécurité ronde. Fixation invisible. M6. Titane laiton poli.



Accessoires

Accessories
Zubehör



0099.990120	M6	70mm	58 - 64
0099.990122	M6	80mm	68 - 74
0099.990121	M6	90mm	78 - 84

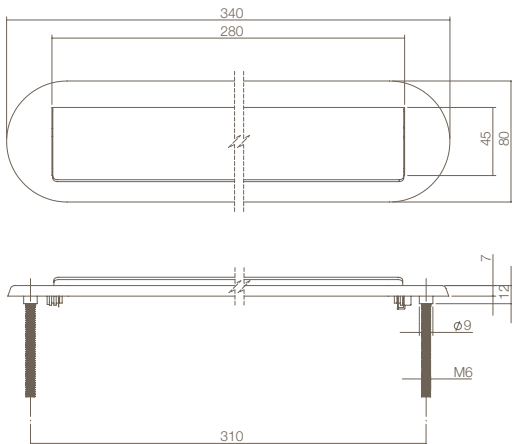

4000



0050.400011 Briefplaat ovaal met regenrand. Klep half naar buitendraaiend. Titanium messing.



Briefeinwurf oval mit Tropfkante. Klappe halb nach aussen öffnend. Messing Titanium.



Letter plate oval with rain edge, opens half outwards. Brass titanium.

Plaque-à-lettres ovale avec clapet/bord de pluie. S'ouvrant à moitié vers l'extérieur. Titane laiton poli.

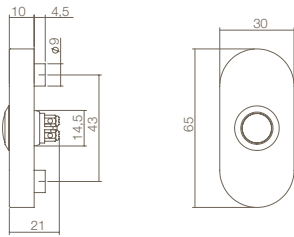

3990

0050.399026 Beldrukker ovaal verdekt. Titanium messing.



Oval concealed bell push. Brass titanium.

Klingelplatte oval verdekt.
Messing Titanium.

Sonnette ovale fixation invisible.
Titane laiton poli.

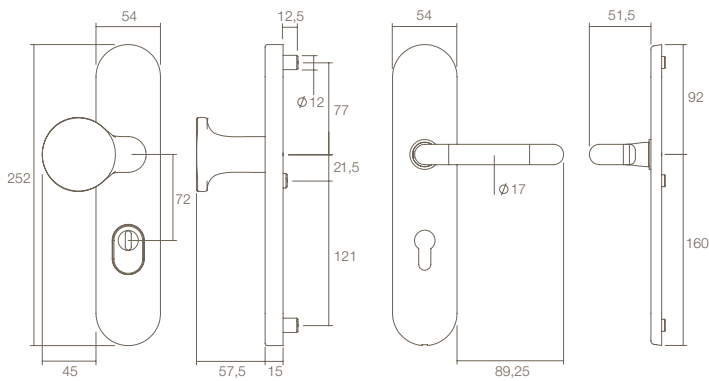

0050.385029		55mm
0050.385036		72mm
0050.385049		92mm

3850



0050.385036

PC veiligheidschilden met kerntrekbeveiliging greep/kruk. Krukhals \varnothing 8mm. Links of rechts te monteren. Stift M14 x 8 x 75mm. Messing titanium.



Security plates pull/handle with cylinder protection. Pull is reversible. Insert \varnothing 18mm. Spindle M14 x 8 x 75mm. Brass titanium.

Sicherheitsgarnitur Drücker/Griffplatte mit Kernziehschutz. Rechts/links verwendbar. Drücker Hals \varnothing 18mm. Stift M14 x 8 x 75mm. Messing Titanium.

Garnitures de sécurité. Tirant réversible. Béquille seule Sigare, droite ou gauche. Cou de \varnothing 18mm. Tige M14 x 8 x 75mm. Titane laiton poli.

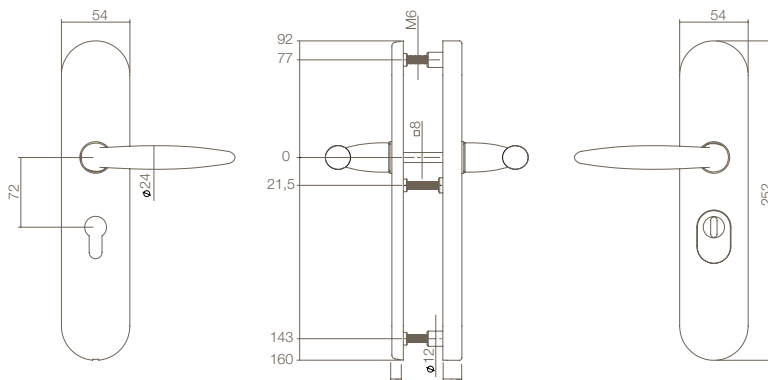

0050.385129		55mm
0050.385136		72mm
0050.385149		92mm

3849



0050.385136

PC veiligheidsschilden kruk/kruk doorgaand met kerntrekbeveiliging. Krukhals \varnothing 18mm. Messing titanium.



Security plates handle/handle with cylinder protection. Insert \varnothing 18mm. Brass titanium.

Schutzbeschlag Drücker/Drücker mit Kernziehschutz. Drücker Hals \varnothing 18mm. Messing Titanium.

Garnitures de securite beq/beq avec cache anti-forage. Bequilles, cou de \varnothing 18mm. Titane laiton poli.

Accessoires Accessories Zubehör



0099.990120	M6	70mm	58 - 64
0099.990122	M6	80mm	68 - 74
0099.990121	M6	90mm	78 - 84



0099.975343	M14	\square 8x75mm	\leq 42
0099.975363	M14	\square 8x90mm	\leq 60
0099.975364	M14	\square 8x120mm	\leq 90



0099.975000	\square 8x105mm	\leq 42
0099.975001	\square 8x120mm	\leq 58
0099.975002	\square 8x150mm	\leq 90

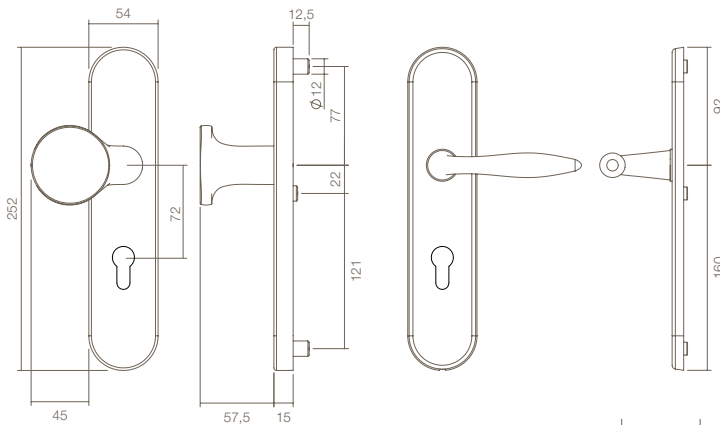

0050.384629		55mm
0050.384636		72mm
0050.384649		92mm



3848

0050.384836

PC veiligheidschilden greep/kruk los. Krukhals \varnothing 18mm. Links of rechtste monteren. Stift M14 x 8 x 75mm. Messing titanium.



Security plates pull/handle. Pull is reversible. Insert \varnothing 18mm. Spindle M14 x 8 x 75mm. Brass titanium.

Sicherheitsgarnitur Drücker/Griffplatte. Rechts/links verwendbar. Drücker Hals \varnothing 18mm. Stift M14 x 8 x 75mm. Messing Titanium.

Garnitures de sécurité. Tirant réversible. Béquille seule, cou de \varnothing 18mm, droite ou gauche. Tige M14 x 8 x 75mm. Titane laiton poli.

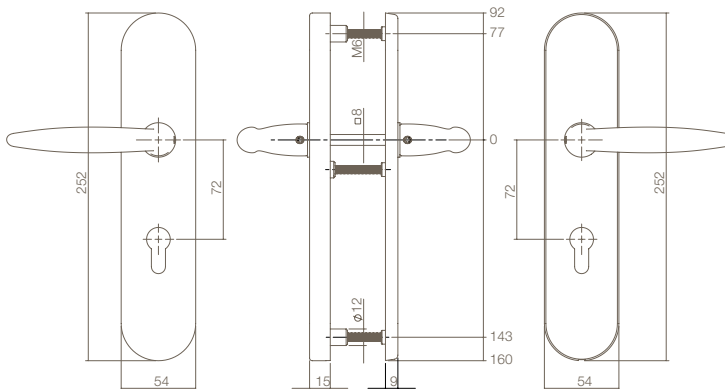

0050.384929		55mm
0050.384936		72mm
0050.384949		92mm

0050.384936

PC veiligheidschilden kruk/kruk los. Krukhals \varnothing 18mm. Links of rechts te monteren. Stift M14 x 8 x 75mm. Messing titanium.



Security plates handle/handle. Pull is reversible. Insert \varnothing 18mm. Spindle M14 x 8 x 75mm. Brass titanium.

Sicherheitsgarnitur Drücker/Drücker. Rechts/links verwendbar. Drücker Hals \varnothing 18mm. Stift M14 x 8 x 75mm. Messing Titanium.

Garnitures de sécurité béq/béq. Tirant réversible. Béquille seule, cou de \varnothing 18mm, droite ou gauche. Tige M14 x 8 x 75mm. Titane laiton poli.

3849



Accessoires

Accessories
Zubehör



0099.990120		M6	70mm		
0099.990122		M6	80mm		
0099.990121		M6	90mm		



0099.975343		M14	\square 8x75mm		
0099.975363		M14	\square 8x90mm		
0099.975364		M14	\square 8x120mm		



0099.975000		\square 8x105mm		
0099.975001		\square 8x120mm		
0099.975002		\square 8x150mm		



Messing titanium - Brass titanium
Messing Titanium - Titane laiton poli

Buitendeurbeslag - Huiscijfers

0050

Exterior door hardware - House numbers

Haustürbeschläge - Hausnummern

Garnitures de portes extérieure - Numéros de maison



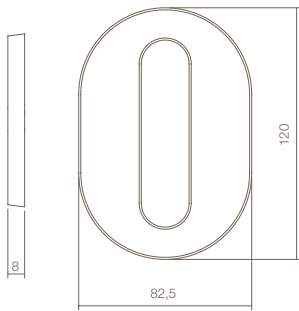

0050.402100	0	120mm
0050.402101	1	120mm
0050.402102	2	120mm
0050.402103	3	120mm
0050.402104	4	120mm
0050.402105	5	120mm
0050.402106	6	120mm
0050.402107	7	120mm
0050.402108	8	120mm
0050.402109	9	120mm

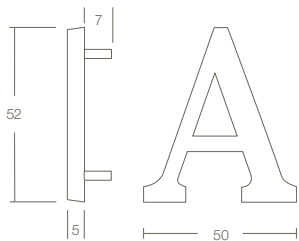

0050.402501	A	50mm
0050.402502	B	50mm

4021



0050.40210x Huiscijfer. Inclusief bevestiging.
Messing titanium.



House number. Including mounting material. Brass titanium.

Hausnummer inkl. Befestigung.
Messing Titanium.

Numéro de maison 120mm. Fixation fournie. Titane laiton poli.

0 1 2 3 4
5 6 7 8 9

4025



0050.40250x Huisletter. Inclusief bevestiging.
Messing titanium.



House letter. Including mounting material. Brass titanium.

Hausnummer inkl. Befestigung.
Messing Titanium.

Lettre de maison. Fixation fournie.
Titane laiton poli.

A B

Over ons

Bij Intersteel is design meer dan alleen esthetische opsmuk. Het is een kwaliteitskenmerk en staat voor de perfecte synthese van vorm en functie. Het resultaat is het plezier dat je elke keer weer ervaart wanneer je onze producten aanpakt.

Eén van de grootste veranderingen in de afgelopen jaren is toch wel de manier waarop creativiteit niet alleen is ingezet bij de ontwikkeling van producten met een toegevoegde waarde, maar ook heeft bijgedragen aan een verandering van het ontwerpproces. We proberen er voortdurend achter te komen wat de behoeften zijn van onze klanten en we blijven werken aan de ontwikkeling van de juiste oplossing.

About us

At Intersteel, design is more than just esthetic adornment. It's a characteristic of quality and is equal to the perfect synthesis of shape and function. The result is the pleasure you experience every time our products are touched upon.

One of the biggest changes in the past years is the way in which creativity has not only been applied in the development of products with added value, but it has also contributed to a change in the design process. Our team continually attempts to discover the needs of our customer and they remain working on the development towards the exact solution for any one.

Über uns

Bei Intersteel, findet sich Design in den Produkten als ein wichtiges Element wieder. Es ist eine Qualitätsmarke, die für perfekte Synthese aus Form und Funktion steht. Das Resultat ist das Vergnügen, dass Sie immer wieder erwartet, wenn Sie mit unseren Produkten in Kontakt kommen. Eine der größten Veränderungen in den letzten Jahren zeigt uns, dass Kreativität nicht allein in der Entwicklung von Produkten mit Mehrwert liegt, sondern auch zu einer Veränderung im Design-Prozess beigetragen hat. Wir sind ständig bemüht herauszufinden, was die Bedürfnisse unserer Kunden sind, um weiterhin die richtige Lösung für Sie zu entwickeln.

Info

Chez Intersteel, le design est plus qu'un ornement.. C'est un gage de qualité, la synthèse parfaite entre forme et fonction, avec pour résultat le plaisir que vous éprouvez, chaque fois que vous l'utilisez.

Un des plus grands changements de ces dernières années est sans doute la façon dont la créativité a non seulement joué son rôle dans le développement de produits à valeur ajoutée, mais a aussi contribué à la transformation du processus de conception. Nous essayons sans cesse de cerner les besoins de nos clients et de leur offrir la meilleure solution.

Technologie

Intersteel heeft een grote verscheidenheid aan producten en ze gaan lang mee. Dat komt doordat we met behulp van de meest geavanceerde technologieën, prachtige en onderscheidende producten fabriceren.

Technology

The assortment of Intersteel shows great diversity and products are long lasting. This is due to the aid of advanced technologies which enables us to produce distinctive products of great design.

Technik

Intersteel hat eine große Anzahl an verschiedenen Produkten, die fester Bestandteil unseres Sortiments geworden sind. Dies ist das Resultat aus Nutzung neuester Technologien, wodurch viele unterschiedliche und qualitative Produkte entstehen.

Technologie

Intersteel dispose d'une grande variété de produits à grande longévité. En utilisant des technologies de pointe, nous créons des produits de haute qualité.

Kwaliteit

Al onze producten voldoen ruim aan de normen waar het beslag voor de diverse toepassingen aan moet voldoen. Zowel de techniek van het beslag als ook de finishes zijn duurzaam getest.

Quality

All our products meet the standards relevant for the applications of these products. Both the technique and finish of our products are tested for their durability.

Qualität

Alle unsere Produkte, sowohl die Befestigungen als auch die Oberflächen, werden gründlich getestet, um die Standards zu erfüllen.

Qualité

Tous les éléments de nos produits ont été soumis à des tests astreignants, peut-être même les plus rigoureux dans ce domaine.

Historie

Intersteel is van oorsprong een familiebedrijf. Alle generaties terug ligt de oorsprong rond 1900. Sinds de jaren '60, '70 is Van Leeuwen International (toen nog Van Leeuwen Agenturen) gespecialiseerd in exclusief bouw- en interieurbeslag. In de begin periode als agent, maar sinds de laatste decennia verloopt de ontwikkeling van de producten volledig in eigen beheer. Maar ook voor 1900 was er een wens voor exclusief deurbeslag. De jarenlange passie van de familie Van Leeuwen voor bouw- en interieurbeslag is dan ook terug te zien in een omvangrijk assortiment oude sloten, complete slotensets, sleutels en deurkrukken. Pronkstukken vanuit de 15e eeuw tot het einde van de 20e eeuw zijn door u te bezichtigen in het slotenmuseum!

History

Intersteel originally is a family company. All generations back the company originated around 1900. Since the 60's & 70's Van Leeuwen International (formerly Van Leeuwen Agencies) is specialized in exclusive building- and interior hardware. In the beginning period as an agency, but since the last years the development of products is managed by our team. But also before 1900 there was a desire for exclusive door hardware. The years of passion and interest for these products by the Van Leeuwen family is visible in the broad assortment of ancient locks, complete lock sets, keys and door handles. Showpieces from the 15th century until the end of the 20th century can be admired in our gallery of locks.

Geschichte

Intersteel ist ursprünglich ein Familienunternehmen, welches bis in das Jahr 1900 zurück geht. Seit den 60er und 70er Jahren des 20. Jahrhunderts, hat sich Van Leeuwen International (damals noch Van Leeuwen Agentur) ausschließlich auf Bau- und Interieur Beschläge spezialisiert. In der Anfangszeit noch als Händler, doch in den letzten Jahrzehnten durch die Entwicklung neuer Produkte erlangte man auch als Produzent einen Rang. Auch im Jahr 1900 gab es einen Wunsch nach exklusiven Türbeschlägen. Die vielen Jahre Leidenschaft der Familie Van Leeuwen für Bau- und Interieur Beschläge wird auch in einem großen gesammelten Sortiment von alten Schlössern, komplette Schloss-Sets, Schlüssel und Türgriffen gezeigt. Glanzstücke des 15. Jahrhundert bis zum Ende des 20. Jahrhundert lassen sich in dem eigenen Schlossmuseum erkunden.

Histoire

Intersteel est à l'origine une entreprise familiale, créée aux alentours de 1900. Depuis les années 60-70, celle-ci (jusqu'alors appelée Van Leeuwen Agenturen) s'est spécialisée dans les garnitures de portes pour le secteur du BTP. Au début, comme agent mais, depuis les dernières décennies, comme spécialiste autonome du développement de ce type de produits. Avant 1900, il existait déjà une demande de garnitures de porte exclusives. La passion familiale et l'intérêt que Van Leeuwen a toujours porté aux produits utilisés dans la construction, se reflète également dans une vaste gamme de serrures anciennes: des ensembles de verrouillage complets, des clés et des poignées de porte, des pièces datant du 15e siècle jusqu'à la fin du 20e. Toutes sont exposées dans le musée que nous vous invitons à visiter!



Visie en missie

Visie

'Intersteel streeft ernaar om middels het verweven van moderne technologieën en elegant design, de mensen om ons heen een prettige en veilige werk- en woonomgeving te bieden.'

Vision

Intersteel strives to offer a controlled working- and living environment through the interference of multiple technologies and the subsequent safe, functional and elegant designs.

Vision

Intersteel, hat das Bestreben durch die Verflechtung der modernen Technologien und dem eleganten Design, den Menschen um sich herum, ein angenehmes und sicheres Arbeits- und Lebensumfeld zu ermöglichen.

Vision

C'est en combinant différents types de technologies et un design élégant, pratique et sûr que Van Leeuwen International vise à offrir à tout un chacun un cadre de travail et un habitat sécurisé.

Missie

'Onze organisatie richt zich op het succesvol ontwikkelen, produceren en vermarkten van innovatieve hang- en sluitwerkoplossingen voor (professionele en particuliere) eindgebruikers, waarbij wij ons ten alle tijden inzetten ten behoeve van het overtreffen van de verwachtingen van onze interne en externe klanten. Daarbij willen wij voor hen een waardevolle partner zijn en staan wij altijd open voor nieuwe uitdagingen en kansen in de markt.'

Mission

Our organization focuses on successfully developing, producing and marketing our innovative hardware solutions for (professional) end users whereby one always aims to surpass all expectations of our internal and external customers. We wish to be a worthy partner and we are always open to new challenges and chances within our market.

Mission

Unsere Organisation konzentriert sich auf die erfolgreiche Entwicklung, Herstellung und Vermarktung innovativer Lösungen von Schließern und Beschlägen für den gewerblichen und privaten Endverbraucher. Wir fühlen uns verpflichtet, die Erwartungen unserer nationalen und internationalen Kunden zu erfüllen. Ferner möchten wir für Sie ein wichtiger Partner sein, immer offen für neue Herausforderungen und alle Chancen am Markt mit Ihnen gemeinsam umzusetzen und zu nutzen.

Mission

"Notre organisation a pour seul objectif de réussir le développement, la fabrication et la commercialisation de formules innovantes de fermetures et de serrures de portes pour des utilisateurs professionnels et autres. Nous voulons être un partenaire idéal, toujours ouvert à de nouveaux défis et l'opportunités du marché".



Kwaliteit



SKG keurmerk

SKG is het keurmerk dat aangeeft dat een product voldoet aan de eisen die de Stichting Kwaliteit Gevelbouw stelt aan inbraakwerendheid en veiligheid. Dit is een landelijke norm.

SKG control mark

SKG is the control mark which indicates if a product meets the set requirements for the prevention of burglary and safety. This is according to national standards.

SKG Label

SKG ist das Markenzeichen, das darauf hinweist, das ein Produkt den Anforderungen an Einbruch und Sicherheit der Gevelbouw Stiftung entspricht. Dies ist eine nationale Norm, die auch für den deutschen Markt zugelassen ist.

Norme SKG

SKG est la norme nationale qui indique qu' un produit répond aux normes "antivol" prévues par la fondation Stichting Kwaliteit Gevelbouw.

EN 1906

EN1906 is de Europese norm en internationale richtlijn voor deurbeslag. Met deze norm streeft men naar Europese harmonisatie en eenduidigheid voor alle landen binnen de EEG.

EN 1906

EN 1906 is the European norm and international guideline for door hardware. With this standard one strives for European harmonization and clarity for all countries within the EEC.

EN 1906

EN1906 ist der europäische Standard und die internationale Richtlinie für Türbeschläge. Bei diesem Verfahren versucht man die europäische Harmonisierung und Klarheit für alle Länder innerhalb der EU zu erreichen.

EN 1906

EN1906 est la norme Européenne et une directive internationale pour les garnitures de portes. Avec cette méthode, on s'oriente vers une harmonisation Européenne et l'uniformité pour tous les pays de la CEE.



DIN 18273

DIN 18273 FS is een internationale norm voor brandvertragend deurbeslag.

DIN 18273

DIN 18273 FS is an international standard for fire retarding door hardware.

DIN 18273

DIN 18273 FS ist eine internationale Norm für Feuerschutzbeschläge

DIN 18273

DIN 18273 FS est une norme internationale pour les garnitures de portes coupe-feu.



NEN 1770

De NEN 1770 is een standaard norm voor de bedieningshoogte en de breedte van de briefgleuf. Deze norm is van toepassing op al onze briefplaten getoond in dit productoverzicht.

NEN 1770

The NEN 1770 standard refers to the operational height and the width of the mail opening. All these specific products in our product overview meet this standard.

NEN 1770

Die NEN 1770 ist eine Standardnorm für die Höhen und Breiten von Briefeinfwürfen. Dieser Standard gilt für all unsere Briefeinfwürfe, die in diesem Katalog gezeigt werden.

NEN 1770

Le NEN 1770 est une norme standard pour contrôler la hauteur et la largeur de l'ouverture d'une plaque-à-lettres. Cette norme est applicable sur toutes nos plaques-à-lettres présentées dans ce catalogue.



Garantie op functionaliteit

Intersteel onderscheidt zich door het bieden van een optimale service, snelle leveringen en een uitstekende kwaliteit. Om de kwaliteit extra te benadrukken bieden wij onze afnemers op alle producten een functionaliiteitsgarantie van tien jaar. De voorwaarden voor deze garantie kunt u bij ons opvragen.

Warranty on functionality

Intersteel is characterized by its offer of optimal service, quick deliveries and excellent quality. To emphasize our quality we offer our customers a ten years warranty of functionality. The conditions for this warranty are available on request.

Garantie auf die Funktion

Intersteel unterscheidet sich von anderen Anbietern. Wir bieten Ihnen einen optimalen Service, schnelle Lieferzeiten und eine ausgezeichnete Qualität. Um die Qualität sicherzustellen, bieten wir unseren Kunden auf alle Produkte eine Funktionsgarantie von 10 Jahren an.

Garantie de fonctionnalité

Intersteel se distingue en offrant le meilleur service possible, une livraison rapide et une qualité irréprochable. A l'appui de cette qualité, nous offrons sur tous nos produits une garantie de fonctionnalité de dix ans. Les conditions sont obtenues par écrit.



ISO 9001

Sinds 1994 is Intersteel in het bezit van het ISO 9001 certificaat. Deze kwaliteitsstandaard beschrijft het bedrijfsproces en is een garantie voor de constante beheersing van alle facetten van de onderneming. De productie, het assortiment, de service en leveringen voldoen aan hoge en streng gecontroleerde normen.

ISO 9001

Since 2001 Intersteel possesses an ISO 9001 certificate. This standard of quality describes the company process and is a warranty for continuously controlling all aspects of the company. The production, the assortment, the service and deliveries all meet these requirements.

ISO 9001

Seit 1994 ist Intersteel in Besitz des ISO 9001-Zertifikats. Dieser Qualitätsstandard beschreibt die Betriebsprozesse und ist ein Garant für die ständige Kontrolle. Alle Abteilungen des Unternehmens werden nach diesem hohen und strengen Standard geprüft.

ISO 9001

Depuis 1994 Intersteel est titulaire du certificat ISO 9001. Cette norme garantie à ses clients un produit de qualité constante, un degré élevé de fiabilité et un excellent service.

Algemene verkoop- en leveringsvoorwaarden

Algemene verkoop- en leveringsvoorwaarden Van Leeuwen Agenturen B.V., handelend onder Van Leeuwen International. Gedeponeerd bij de Kamer van Koophandel op 20 februari 2015

Artikel 1: Toepasselijkheid

1.1. Tenzij uitdrukkelijk anders is overeen-gekomen, zijn deze voorwaarden van toepassing op alle aanbiedingen, overeenkomsten van koop en verkoop en leveringen van alle goederen en diensten, die door Van Leeuwen International (hierna "verkoper") in de handel worden gebracht en/of verstrekt. Koper aanvaardt de toepasselijkheid van deze voorwaarden door het enkele feit van zijn opdracht. Algemene of specifieke door de koper gehanteerde Inkoopvoorwaarden worden door de verkoper niet aanvaard en zijn op de door deze voorwaarden beheerste aanbiedingen, overeenkomsten en leveringen niet van toepassing tenzij en nadat de bedoelde Inkoopvoorwaarden uitdrukkelijk schriftelijk door de verkoper (en, indien deze een rechtspersoon is, door een bestuurder daarvan) van toepassing zijn verklaard op enigerlei specifieke transactie.

1.2. Indien schriftelijk uitdrukkelijk anders is overeen-gekomen, gelden Inkoopvoorwaarden van koper slechts voor zover deze niet in strijd zijn met de algemene verkoopvoorwaarden van Van Leeuwen International. In geval van twijfel omtrent de vraag of zodanige strijdigheid aanwezig is, prevaleren de algemene verkoopvoorwaarden van Van Leeuwen International. Aanvaarding op deze wijze van de toepasselijkheid van zodanige Inkoopvoorwaarden zal in geen geval met zich brengen, dat die Inkoop-voorwaarden ook op andere transacties tussen koper en verkoper van toepassing (zullen) zijn. Indien en voor zover een aanbidding en/of overeenkomst tussen koper en verkoper van de door deze voorwaarden beheerste aanbiedingen en/of overeenkomsten afwijkende bepalingen bevat zonder dat de toepasselijkheid van deze voorwaarden uitdrukkelijk is uitgesloten, blijven de overige bepalingen van deze voorwaarden onverminderd van kracht.

1.3. Een ieder die bij Van Leeuwen International goederen bestelt zal gelden als koper, ook indien op verzoek van de koper de factuur van de betreffende levering op naam van een ander wordt gesteld en/of aan deze ander wordt gestuurd en/of de factuur door deze ander wordt betaald. Daarnaast geldt een ieder jegens Van Leeuwen International als koper aan wie levering heeft plaatsgevonden.

Artikel 2: Aanbiedingen, adviezen en bestellingen

2.1. Alle offerten en prijsopgaven zijn vrijblijvend en kunnen door de verkoper herroepen worden, evenwel met dien verstande dat verkoper aan de in schriftelijke prijsopgaven opgegeven netto prijzen is gebonden gedurende een periode van 30 dagen, te rekenen van de verzending van de betreffende prijsopgave. Alle prijzen zijn in netto contant, zonder korting en exclusief ten tijde van de levering verschuldigde belastingen. Wordt een bestelling gedaan zonder dat een prijs uitdrukkelijk overeengekomen is, dan wordt deze ongeacht vroeger gemaakte offerte of vroeger berekende prijs, tegen de ten tijde van de uitvoering der bestelling geldende prijs uitgevoerd.

2.2. Retourzendingen in andere hoeveelheden dan deze verpakkingseenheden worden niet geaccepteerd. Maten en gewichten worden bij benadering en zonder verplichting van Van Leeuwen International opgegeven.

2.3. Verpakking wordt tegen de daarvoor in aanmerking komende kostprijs berekend. Voor geleverde emballage wordt statiegeld in rekening gebracht. Verkoper is indien hij niet aan een ter zake uitgebrachte offerte is gehouden gerechtigd orders niet te accepteren. Hij is in dat geval gehouden koper daarvan bericht te zenden binnen 5 werkdagen, te rekenen van de ontvangst van de order.

2.4. Elke overeenkomst wordt door Van Leeuwen International. aangegaan onder de opschortende voorwaarde, dat de kredietwaardigheid van de koper naar het oordeel van Van Leeuwen International. voldoende blijkt te zijn.

2.5. Een speciale bestelling is een bestelling die buiten het reguliere assortiment van Van Leeuwen International valt. Voor speciale bestellingen gelden afwijkende prijzen en/of levertijden, die schriftelijk per bestelling worden overeengekomen. Afzonderlijk voor een koper door Van Leeuwen International bestelde goederen kunnen niet worden geannuleerd en bij de juiste uitvoering van een speciale bestelling worden deze goederen nimmer door Van Leeuwen International retour genomen. Bij speciale bestellingen onder €150,- netto exclusief BTW, worden kosten in rekening gebracht voor vracht en behandeling.

2.6. Als de aanbidding niet wordt aanvaard, heeft Van Leeuwen

International het recht alle kosten die hij heeft moeten maken om zijn aanbidding te doen bij opdrachtgever in rekening te brengen.

2.7. Opdrachtgever kan geen rechten ontleen aan adviezen en informatie die hij van Van Leeuwen International krijgt als deze geen directe betrekking hebben op de opdracht.

2.8. Opdrachtgever is verantwoordelijk voor de door of namens hem gemaakte tekeningen, berekeningen, ontwerpen en voor de functionele geschiktheid van door of namens hem voorgeschreven materialen.

2.9. Opdrachtgever vrijwaart Van Leeuwen International voor elke aanspraak van derden met betrekking tot het gebruik van door of namens opdrachtgever verstrekte tekeningen, berekeningen, ontwerpen, materialen, monsters, modellen en dergelijke.

2.10. Opdrachtgever mag de materialen die Van Leeuwen International wil gebruiken voordat deze worden verwerkt voor eigen rekening (laten) onderzoeken. Als Van Leeuwen International hierdoor schade lijdt, komt deze voor rekening van opdrachtgever.

Artikel 3: Rechten van intellectueel eigendom

3.1. Tenzij schriftelijk anders is overeengekomen, behoudt Van Leeuwen International de auteursrechten en alle rechten van industrieel eigendom op de door hem gedane aanbiedingen, verstrekte ontwerpen, afbeeldingen, tekeningen, modellen, programmatuur enz.

3.2. De rechten blijven eigendom van Van Leeuwen International ongeacht of aan opdrachtgever voor de vervaardiging ervan kosten in rekening zijn gebracht. Deze gegevens mogen zonder voorafgaande uitdrukkelijke schriftelijke toestemming van Van Leeuwen International niet worden gekopieerd, gebruikt of aan derden getoond. Opdrachtgever is aan Van Leeuwen International per overtreding van deze bepaling een boete verschuldigd van € 25.000. Deze boete kan naast schadevergoeding op grond van de wet worden gevorderd.

3.3. Opdrachtgever moet de aan hem verstrekte gegevens op eerste verzoek binnen de door Van Leeuwen International gestelde termijn retourneren. Bij overtreding van deze bepaling is opdrachtgever aan Van Leeuwen International een boete verschuldigd van € 1.000 per dag. Deze boete kan naast schadevergoeding op grond van de wet worden gevorderd.

Artikel 4: levering

4.1. De levertijd en/of uitvoeringsperiode worden door Van Leeuwen International bij benadering vastgesteld.

4.2. Bij de vaststelling van de levertijd en/of uitvoeringsperiode gaat Van Leeuwen International er van uit dat hij de opdracht kan uitvoeren onder de omstandigheden die hem op dat moment bekend zijn.

4.3. De levertijd en/of uitvoeringsperiode gaat pas in wanneer over alle commerciële en technische details overeenstemming is bereikt, alle noodzakelijke gegevens, definitieve, goedgekeurde tekeningen enz. in het bezit zijn van Van Leeuwen International B.V., de overeengekomen (termijn)betaling is ontvangen én aan de noodzakelijke voorwaarden voor de uitvoering van de opdracht is voldaan.

4.4.1. Als er sprake is van andere omstandigheden dan die welke Van Leeuwen International bekend waren toen hij de levertijd en/of uitvoeringsperiode vaststelde, kan Van Leeuwen International de levertijd en/of uitvoeringsperiode verlengen met de tijd nodig om de opdracht onder deze omstandigheden uit te voeren. Als de werkzaamheden niet in de planning van Van Leeuwen International kunnen worden ingepast, zullen deze worden uitgevoerd zodra zijn planning dit toelaat.

4.4.2. Als er sprake is van meerwerk wordt de levertijd en/of uitvoeringsperiode verlengd met de tijd nodig om de materialen en onderdelen daarvoor te (laten) leveren en om het meerwerk te verrichten. Als het meerwerk niet in de planning van Van Leeuwen International kan worden ingepast, zullen de werkzaamheden worden uitgevoerd zodra de planning dit toelaat.

4.4.3. Als er sprake is van opschorting van verplichtingen door Van Leeuwen International worden de levertijd en/of uitvoeringsperiode verlengd met de duur van de opschorting. Als voortzetting van de werkzaamheden niet in de planning van Van Leeuwen International kan worden ingepast, zullen de werkzaamheden worden uitgevoerd zodra de planning dit toelaat.

4.4.4. Als er sprake is van onwerkbaar weer wordt de levertijd

en/of uitvoeringsperiode verlengd met de daardoor ontstane vertraging.

4.5. Overschrijding van de overeengekomen levertijd en/of uitvoeringsperiode geeft in geen geval recht op schadevergoeding, tenzij dit schriftelijk is overeengekomen.

Artikel 5: Prijswijziging

5.1. Een stijging van kostprijsbepalende factoren ontstaan na het sluiten van de overeenkomst mag door Van Leeuwen International worden doorberekend aan opdrachtgever als de nakoming van de overeenkomst ten tijde van de stijging nog niet is voltooid.

5.2. Opdrachtgever is gehouden de prijsstijging zoals bedoeld in lid 1 te voldoen tegelijk met betaling van de hoofdsom of de eerstvolgende overeengekomen betalingstermijn.

Artikel 6. Leveringsvoorwaarden

6.1. Levering van zaken geschiedt franco vanaf € 150,- ex. btw en ongelost op de door de opdrachtgever aangegeven plaats, met dien verstande dat deze plaats, die in de orderbevestiging schriftelijk moet worden vermeld, zich bevindt op de begane grond (straatniveau). Lossing heeft plaats door en voor rekening van de opdrachtgever, direct na aankomst van de zaken.

6.2. Controle op de kwantiteit en kwaliteit dient door de opdrachtgever onmiddellijk na aankomst van de zaken te geschieden en eventuele klachten uit dien hoofde dienen ogenblikkelijk schriftelijk bij Van Leeuwen International te worden aangemeld. Laat de opdrachtgever dit na, vervalt daarmee het recht uit dien hoofde te reclameren.

Artikel 7. Betalingsvoorwaarden

Alle door ons geleverde zaken blijven, zolang zij niet zijn betaald, ons eigendom totdat het totale orderbedrag door de opdrachtgever is voldaan. Betaling geschiedt binnen 30 dagen netto tenzij schriftelijk anders overeengekomen.

Artikel 8. Aansprakelijkheid

8.1. Van Leeuwen International is niet aansprakelijk voor directe of indirecte schade, door opdrachtgever geleden, ten gevolge van latente gebreken aan geleverde goederen. Van Leeuwen International is ook niet aansprakelijk voor schade ontstaan tijdens transport van de goederen.

8.2. Van Leeuwen International is niet aansprakelijk voor opzichtschaade. Onder opzichtschaade wordt onder andere verstaan, schade die door of tijdens de uitvoering van het werk wordt toegebracht aan zaken waaraan wordt gewerkt of aan zaken die zich bevinden in de nabijheid van de plaats waar wordt gewerkt. Opdrachtgever dient zich desgewenst tegen deze schade te verzekeren.

8.3. Van Leeuwen International is niet aansprakelijk voor bedrijfsschade, bijvoorbeeld stagnatieschade en gederfde winst, of voor schade als gevolg van opzet of roekeloosheid van hulppersonen of niet leidinggevende ondergeschikten van Van Leeuwen International.

8.4. Van Leeuwen International is niet aansprakelijk voor schade aan door of namens opdrachtgever aangeleverd materiaal ten gevolge van een niet deugdelijk uitgevoerde bewerking. Op verzoek van opdrachtgever zal Van Leeuwen International de bewerking opnieuw uitvoeren, met door opdrachtgever voor diens rekening aangeleverd nieuw materiaal.

8.5. Opdrachtgever vrijwaart Van Leeuwen International voor alle aanspraken van derden wegens productenaansprakelijkheid als gevolg van een gebrek in een product dat door opdrachtgever aan een derde is geleverd en dat (mede) bestond uit door Van Leeuwen International geleverde producten en/of materialen.

Artikel 9. Garantie

9.1. Van Leeuwen International staat voor een periode van zes maanden na (op)levering of anders overeengekomen voor de goede uitvoering van de overeengekomen prestatie.

9.2. Bestaat de overeengekomen prestatie (mede) uit het bewerken van door opdrachtgever aangeleverd product dan staat Van Leeuwen International voor de in lid 1 genoemde periode in voor de deugdelijkheid van de uitgevoerde bewerking. Als blijkt dat een bewerking niet deugdelijk is uitgevoerd, zal Van Leeuwen International de keuze maken of hij:

- de bewerking opnieuw uitvoert. In dat geval moet opdrachtgever voor eigen rekening nieuw materiaal aanleveren;
- het gebrek herstelt. In dat geval moet opdrachtgever het materiaal franco aan Van Leeuwen International terugzenden;

- opdrachtgever crediteert voor een evenredig deel van de factuur.

9.3. Bestaat de overeengekomen prestatie uit levering van een zaak dan staat Van Leeuwen International gedurende de in lid 1 genoemde periode in voor de deugdelijkheid van de geleverde zaak. Als blijkt dat de levering niet deugdelijk is geweest, dan moet de zaak franco aan Van Leeuwen International worden teruggezonden. Daarna zal Van Leeuwen International de keuze maken of hij:

- de zaak herstelt;
- de zaak vervangt;
- opdrachtgever crediteert voor een evenredig deel van de factuur.

9.4. Bestaat de overeengekomen prestatie (mede) uit de installatie en/of montage van een geleverde zaak dan staat Van Leeuwen International B.V. voor de in lid 1 genoemde periode in voor de deugdelijkheid van de installatie en/of montage. Als blijkt dat de installatie en/of montage niet deugdelijk is uitgevoerd, zal Van Leeuwen International dit herstellen. De eventueel gemaakte reis- en verblijfkosten komen voor rekening van opdrachtgever.

9.5. Voor die onderdelen waarvoor opdrachtgever en Van Leeuwen International dit uitdrukkelijk schriftelijk zijn overeengekomen geldt fabrieksgarantie. Als opdrachtgever gelegenheid heeft gehad kennis te nemen van de inhoud van de fabrieksgarantie zal deze in de plaats treden van garantie op grond van dit artikel.

9.6. Opdrachtgever moet Van Leeuwen International in alle gevallen de gelegenheid bieden een eventueel gebrek te herstellen en/of de bewerking opnieuw uit te voeren.

9.7. Opdrachtgever kan alleen een beroep doen op garantie nadat hij aan al zijn verplichtingen ten opzichte van Van Leeuwen International heeft voldaan.

9.8. Garantie is alleen dan van toepassing wanneer het product in de juiste situatie wordt toegepast, op correcte wijze is gemonteerd, op de juiste wijze wordt gebruikt en onderhouden en wanneer afdoende beschermende maatregelen zijn genomen.

9.9. Geen garantie wordt gegeven zodra gebreken het gevolg zijn van:

- normale slijtage of vervuiling;
- onzorgvuldig handelen of onoordeelkundig gebruik;
- niet of onjuist uitgevoerd onderhoud;
- installatie, montage, wijziging of reparatie door opdrachtgever of door derden.
- defecten aan of onjuiste afstelling van andere producten aan het element of het element zelf.
- gebruik van product in combinatie of samenstelling met producten van derden.

9.10. Geen garantie wordt gegeven op geleverde zaken die niet nieuw waren op het moment van levering of op zaken die door opdrachtgever zijn voorgeschreven of door of namens hem zijn aangeleverd;

9.11. Geen garantie wordt gegeven op het keuren en/of repareren van zaken van opdrachtgever.

Artikel 10: Reclamaties

10.1. Reclames dienen gemotiveerd binnen 5 dagen na de datum van ontvangst van het geleverde product of dienst, schriftelijk ter kennis van de verkoper gebracht te worden. Goederen kunnen slechts door de koper geretourneerd worden na verkregen toestemming van de verkoper. De kosten verbonden aan het retour zenden van de goederen zijn voor rekening van de koper.

10.2. Indien na melding van een reclame uit onderzoek blijkt dat de oorzaak niet aan product van verkoper is te wijten, heeft verkoper het recht om de gemaakte kosten bij de koper in rekening te brengen.

Artikel 11: Niet afgenomen zaken

Wanneer zaken na het verstrijken van de levertijd niet zijn afgenomen, blijven deze ter beschikking staan van opdrachtgever. Niet afgenomen zaken worden voor rekening en risico van opdrachtgever opgeslagen. Van Leeuwen International mag altijd gebruik maken van de bevoegdheid van artikel 6:90 BW.

Artikel 12: Betaling

12.1. Betaling wordt gedaan op de plaats van vestiging van Van Leeuwen International of op een door Van Leeuwen International aangewezen rekening.

12.2. Tenzij anders overeengekomen vindt betaling als volgt plaats:

- a. bij balieverkoop contant;
- b. in alle overige gevallen binnen dertig dagen na factuurdatum.

12.3. Ongeacht de overeengekomen betalings-condities is opdrachtgever verplicht op verzoek van Van Leeuwen International een naar diens oordeel voldoende zekerheid voor betaling te verstrekken. Als opdrachtgever hier niet binnen de gestelde termijn aan voldoet, raakt hij direct in verzuim. Van Leeuwen International heeft in dat geval het recht de overeenkomst te ontbinden en zijn schade op opdrachtgever te verhalen.

12.4. Het recht van opdrachtgever om zijn vorderingen op Van Leeuwen International te verrekenen is uitgesloten, tenzij er sprake is van faillissement van Van Leeuwen International of de gerechtelijke schuldsanering op Van Leeuwen International van toepassing is.

12.5. De volledige vordering tot betaling is onmiddellijk opeisbaar als:

- a. een betalingstermijn is overschreden;
- b. opdrachtgever failliet is gegaan of surseance van betaling aanvraagt;
- c. beslag op zaken of vorderingen van opdrachtgever wordt gelegd;
- d. opdrachtgever (vennootschap) wordt ontbonden of geliquideerd;
- e. opdrachtgever (natuurlijk persoon) het verzoek doet te worden toegelaten tot de gerechtelijke schuldsanering, onder curatele wordt gesteld of overlijdt.

12.6. Wanneer betaling niet heeft plaatsgevonden binnen de overeengekomen betalingstermijn, is opdrachtgever direct rente aan Van Leeuwen International verschuldigd. De rente bedraagt 12% per jaar, maar is gelijk aan de wettelijke rente als deze hoger is. Bij de renteberekening wordt een gedeelte van de maand gezien als een volle maand.

12.7. Wanneer betaling niet heeft plaatsgevonden binnen de overeengekomen betalingstermijn is opdrachtgever aan Van Leeuwen International alle buitengerechtelijke kosten verschuldigd met een minimum van € 75,-.

De kosten worden berekend op basis van de volgende tabel:

- over de eerste € 3.000,= 15%
- over het meerdere tot € 6.000,= 10%
- over het meerdere tot € 15.000,= 8%
- over het meerdere tot € 60.000,= 5%
- over het meerdere vanaf € 60.000,= 3%

Als de werkelijk gemaakte buitengerechtelijke kosten hoger zijn dan uit bovenstaande berekening volgt, zijn de werkelijk gemaakte kosten verschuldigd.

12.8. Als Van Leeuwen International in een gerechtelijke procedure in het gelijk wordt gesteld, komen alle kosten die hij in verband met deze procedure heeft gemaakt voor rekening van opdrachtgever.

Artikel 13: Eigendomsvoorbehoud en pandrecht

13.1. Na levering blijft Van Leeuwen International eigenaar van geleverde zaken zolang opdrachtgever:

- a. tekortschiet of tekort zal schieten in de nakoming van zijn verplichtingen uit deze overeenkomst of andere gelijksoortige overeenkomsten;
- b. voor verrichte of nog te verrichten werkzaamheden uit zodanige overeenkomsten niet betaalt of zal betalen;
- c. vorderingen die voortvloeien uit het niet nakomen van bovengenoemde overeenkomsten, zoals schade, boete, rente en kosten, niet heeft voldaan.

13.2. Zolang er op geleverde zaken een eigendomsvoorbehoud rust, mag opdrachtgever deze buiten zijn normale bedrijfsuitoefening niet bezwaren.

13.3. Nadat Van Leeuwen International zijn eigendomsvoorbehoud heeft ingeroepen, mag hij de geleverde zaken terug halen. Opdrachtgever staat Van Leeuwen International toe de plaats te betreden waar deze zaken zich bevinden.

13.4. Als Van Leeuwen International geen beroep kan doen op zijn eigendomsvoorbehoud omdat de geleverde zaken zijn vermengd, vervormd of nageetrokken, is opdrachtgever verplicht de nieuw gevormde zaken aan Van Leeuwen International te verpanden.

Artikel 14: Beëindiging

Als opdrachtgever de overeenkomst wil ontbinden zonder dat er sprake is van een tekortkoming van Van Leeuwen International en Van Leeuwen International hiermee instemt, wordt de overeenkomst met wederzijds goedvinden beëindigd. Van Leeuwen International heeft in dat geval recht op vergoeding van alle vermogensschade zoals geleden verlies, gederfde winst en gemaakte kosten.

Artikel 15: Toepasselijk recht en bevoegde rechter

15.1. Het Nederlands recht is van toepassing.

15.2. Het Weens koopverdrag (C.I.S.G.) is niet van toepassing, evenmin als enige andere internationale regeling waarvan uitsluiting is toegestaan.

15.3. Alleen de Nederlandse burgerlijke rechter die bevoegd is in de vestigingsplaats van Van Leeuwen International neemt kennis van geschillen, tenzij dit in strijd is met het dwingend recht. Van Leeuwen International mag van deze bevoegdheidsregel afwijken en de wettelijke bevoegdheidsregels hanteren.

15.4. Partijen kunnen een andere vorm van geschillenbeslechting zoals bijvoorbeeld arbitrage of mediation overeenkomen.

Please contact our export department for our international payment and delivery terms.

Unsere Exportabteilung stellt Ihnen gerne unsere Liefer- und Zahlungsbedingungen zur Verfügung.

S.V.P. contacter notre département Export pour nos conditions de paiement international et nos termes de livraison.

Commerciële medewerkers

Bij Intersteel staat u, onze klant, voorop! Wij vinden het belangrijk u zo goed mogelijk te bedienen en te voldoen aan uw wensen en verwachtingen. Op een klantvriendelijke manier proberen wij u altijd te woord te staan. U kunt ons op werkdagen al vanaf 8:00 uur bereiken tot 17:15 uur. Op vrijdag van 8:00 uur tot 16:00 uur. Onze medewerkers hebben door de jaren heen veel kennis opgebouwd en zullen er alles aan doen om uw vragen te beantwoorden. Tot slot willen we voor u een vertrouwd gezicht creëren, daarom kunt u hieronder de contactgegevens vinden, zowel voor de buitendienst als binnendienst.

Commercial employees

At Intersteel we say, customer first. We find it important to deliver service at the highest level. You can contact us at workdays starting at 8:00 am until 17:15 pm. On Friday at 8:00 am until 16:00 pm. Over the years, our employees built up a lot of knowledge and will do anything to answer your questions. You can find the contact details below.

INTERSTEEL Mitarbeiter

Unser Motto bei Intersteel lautet: Der Kunde ist König. Als unsere Hauptaufgabe verstehen wir es es, Service auf höchstem Niveau zu geben. An Werktagen sind für Sie in der Zeit von 08.00 Uhr bis 17.15 Uhr erreichbar. Am Freitag von 08:00 Uhr bis 16:00 Uhr. Das unten aufgeführte Verkaufsteam von INTERSTEEL freut sich Ihnen durch seine langjährige Berufserfahrung und Kompetenz, mit Ihrem fundiertem Fachwissen gerne weiter zu helfen. Unten finden Sie die Kontaktdaten des Innen und Außendienstes.

Notre équipe commerciaux

Afin de répondre au mieux à votre attente, notre équipe reste à votre service pour toute information. Nous sommes à votre disposition les jours ouvrables entre 8.00 et 17.15 heures. Vendredi jusqu'à 16.00 heures. Vous pouvez trouver les détails pour contact ci-dessous.

Accountmanagers



Henk van den Bosch
Accountmanager
henk.vandenbosch@intersteel.nl
T: +31 (0)6 11 38 52 57



Maarten ter Horst
Projectadviseur
Project Advisor
Projektberater
Conseiller de projet
maarten.terhorst@intersteel.nl
T: +31 (0)6 53 99 31 59



George de Beer
Accountmanager
george.debeer@intersteel.nl
T: +31 (0)6 50 24 40 49



Paul Jansen
Accountmanager
paul.jansen@intersteel.nl
T: +31 (0)6 06 50 24 40 46



Marc Pastoors
Accountmanager
marc.pastoors@intersteel.nl
T: +31 (0)6 83 52 83 63

Sales - Verkauf - Vendeur



Sebastiaan Klootwijk
Export Manager
bas.klootwijk@intersteel.nl
T: +31 (0)6 21 55 49 50



Ard van den Bovenkamp
Verkoper Binnendienst
Sales
Verkauf
Vendeur
ard.vandenbovenkamp@intersteel.nl
T: +31 (0)318 47 77 42



Jan Willem Stropkap
Verkoper Binnendienst
Sales
Verkauf
Vendeur
janwillem.stropkap@intersteel.nl
T: +31 (0)318 47 77 41



Henry Gouw
Verkoper Binnendienst
Sales
Verkauf
Vendeur
henry.gouw@intersteel.nl
T: +31 (0)318 47 77 40



André Pauw
Medewerker export
Export Sales Professional
Mitarbeiter Export
Employé export
andre.pauw@intersteel.nl
T: +31 (0)318 47 77 50



Neline van den Brink
Ondersteuning Binnendienst
Sales Support
Vertriebsunterstützung
Aide à la vente
neline.vandenbrink@intersteel.nl
T: +31 (0)318 47 77 77

Index

Art.nr.	Pag.	Art.nr.	Pag.	Art.nr.	Pag.	Art.nr.	Pag.	Art.nr.	Pag.	Art.nr.	Pag.	Art.nr.	Pag.
0010.020100	12	0010.400005	19	0011.256863	54	0011.384649	62	0013.021100	83	0013.253867	98	0013.322004	86
0010.020100A	12	0010.401500	19	0011.256865	54	0011.393031	58	0013.021100A	83	0013.254911	98	0013.322116	88
0010.023400	12	0010.401503	25	0011.256867	54	0011.393033	58	0013.021300	82	0013.254924	98	0013.370001	86
0010.023400A	12	0010.403500	20	0011.257011	44	0011.393046	64	0013.021300A	82	0013.254926	98	0013.370002	87
0010.032300	12	0010.426192	40	0011.257011	54	0011.399027	61	0013.021600	80	0013.254928	98	0013.370101	87
0010.032400	12	0010.426193	40	0011.257024	54	0011.399028	61	0013.021600A	80	0013.254929	98	0013.370557	81
0010.032400A	12	0010.442040	38	0011.257026	54	0011.399029	66	0013.022500	82	0013.254936	98	0013.370557	82
0010.037100	13	0010.561550A	30	0011.257029	54	0011.399033	66	0013.022500A	82	0013.254965	98	0013.370558	81
0010.037100A	13	0010.561550B	30	0011.257036	54	0011.400001	65	0013.022902	94	0013.254967	98	0013.370558	82
0010.037500	13	0010.561580	30	0011.257063	54	0011.400005	60	0013.023400	81	0013.254969	98	0013.370560	81
0010.037500A	13	0010.561600	42	0011.257065	54	0011.401500	60	0013.023400A	81	0013.256811	102	0013.370560	82
0010.037700	13	0010.561601	42	0011.257067	54	0011.401503	65	0013.024300	85	0013.256824	102	0013.370660	81
0010.037700A	13	0010.562000	32	0011.257711	55	0011.402020	70	0013.024300A	85	0013.256826	102	0013.370660	82
0010.037800	13	0010.562001	32	0011.257724	55	0011.402021	70	0013.025400	80	0013.256829	102	0013.370860	85
0010.037800A	13	0010.562004	33	0011.257726	55	0011.402022	70	0013.025400A	80	0013.256836	102	0013.370960	80
0010.038800	14	0010.562004	36	0011.257729	55	0011.402023	70	0013.025902	94	0013.256863	102	0013.370960	85
0010.038800A	14	0010.562007	32	0011.257736	55	0011.402024	70	0013.025902A	94	0013.256865	102	0013.371059	86
0010.318304	13	0010.562007	36	0011.257749	55	0011.402025	70	0013.027700	83	0013.256867	102	0013.371060	86
0010.318316	13	0010.562020	32	0011.257762	55	0011.402026	70	0013.027700A	83	0013.256911	102	0013.375060	108
0010.318317	13	0010.562035	33	0011.257763	55	0011.402027	70	0013.027700B	83	0013.256924	102	0013.375100	108
0010.318360	13	0010.562036	34	0011.257765	55	0011.402028	70	0013.027800	83	0013.256926	102	0013.375130	108
0010.318604	12	0010.562060A	35	0011.257767	55	0011.402029	70	0013.027800A	83	0013.256929	102	0013.375140	116
0010.318604	14	0010.562060B	35	0011.258011	44	0011.561560A	73	0013.027800B	83	0013.256936	102	0013.381929	113
0010.318616	12	0010.875260	42	0011.258011	52	0011.561560B	73	0013.028202	93	0013.257711	103	0013.381936	113
0010.318616	14	0011.020100	44	0011.258024	52	0011.561580	75	0013.028402	93	0013.257724	103	0013.381949	113
0010.318617	12	0011.020100A	44	0011.258026	52	0011.561581	75	0013.028402A	93	0013.257726	103	0013.382029	112
0010.318617	14	0011.020600	44	0011.258029	52	0011.561589	75	0013.028402B	93	0013.257729	103	0013.382036	112
0010.318660	12	0011.020600A	44	0011.258036	52	0011.561620	78	0013.028702	93	0013.257736	103	0013.382049	112
0010.322004	12	0011.021300	44	0011.258065	52	0011.561640	78	0013.031800	83	0013.257742	103	0013.382129	113
0010.322004	14	0011.021300A	44	0011.258067	52	0011.605000	72	0013.031800A	83	0013.257749	103	0013.382136	113
0010.370001	12	0011.021500	44	0011.315620	54	0011.605011	72	0013.032300	89	0013.257765	103	0013.382149	113
0010.370001	14	0011.021500A	44	0011.317304	44	0011.605013	72	0013.032300A	89	0013.257767	103	0013.382429	119
0010.375060	18	0011.022500	45	0011.317316	44	0011.661650A	73	0013.032400	89	0013.315604	80	0013.382436	119
0010.375100	18	0011.022500A	45	0011.317317	44	0011.661650B	73	0013.032400A	89	0013.315616	80	0013.382529	120
0010.375140	24	0011.023400	45	0011.317360	44	0011.661651A	74	0013.036800	83	0013.315617	80	0013.382536	120
0010.381929	22	0011.023400A	45	0011.318304	48	0011.661651B	74	0013.036800A	83	0013.315619	80	0013.382549	120
0010.381936	22	0011.025400	45	0011.318316	48	0011.661652A	74	0013.037100	86	0013.315620	98	0013.384629	112
0010.381949	22	0011.025400A	45	0011.318317	48	0011.661652B	74	0013.037100A	86	0013.315660	80	0013.384636	112
0010.382029	21	0011.027800	45	0011.318360	48	0013.019402	92	0013.037500	86	0013.317304	82	0013.384649	112
0010.382036	21	0011.027800A	45	0011.318504	46	0013.019402A	92	0013.037500A	86	0013.317316	82	0013.390029	119
0010.382049	21	0011.027800B	45	0011.318516	46	0013.019402B	92	0013.037700	86	0013.317317	82	0013.390036	119
0010.382129	22	0011.031500	46	0011.318517	46	0013.019502	92	0013.037700A	86	0013.317319	88	0013.390049	119
0010.382136	22	0011.031500A	46	0011.318560	46	0013.019502A	92	0013.037800	85	0013.317360	82	0013.390129	120
0010.382149	22	0011.032300	46	0011.318604	45	0013.019502B	92	0013.037800A	85	0013.318004	80	0013.390136	120
0010.382436	27	0011.032300A	46	0011.318616	45	0013.019711	96	0013.038800	82	0013.318304	86	0013.390149	120
0010.382449	27	0011.032400	46	0011.318617	45	0013.019724	96	0013.038800A	82	0013.318316	86	0013.393030	106
0010.382529	27	0011.032400A	46	0011.318660	45	0013.019729	96	0013.253011	97	0013.318317	86	0013.393031	106
0010.382536	27	0011.037500	48	0011.318904	49	0013.019736	96	0013.253015	97	0013.318360	86	0013.393033	106
0010.382549	27	0011.037500A	48	0011.318916	49	0013.019765	96	0013.253024	97	0013.318404	85	0013.393034	107
0010.384629	21	0011.037700	47	0011.318960	49	0013.019811	96	0013.253026	97	0013.318416	85	0013.393046	116
0010.384636	21	0011.037700A	47	0011.322004	44	0013.019811A	96	0013.253029	97	0013.318417	85	0013.397500	106
0010.384649	21	0011.037800	47	0011.370960	44	0013.019811B	96	0013.253036	97	0013.318460	85	0013.397500	236
0010.393030	16	0011.037800A	47	0011.375060	59	0013.019824	96	0013.253063	97	0013.318504	89	0013.399010	110
0010.393031	16	0011.038800	47	0011.375100	59	0013.019829	96	0013.253065	97	0013.318516	89	0013.399023	110
0010.393033	16	0011.038800A	47	0011.375140	64	0013.019836	96	0013.253067	97	0013.318517	89	0013.399025	111
0010.393034	17	0011.042000	49	0011.381929	62	0013.019863	96	0013.253511	97	0013.318560	89	0013.399027	110
0010.393046	24	0011.042000A	49	0011.381936	62	0013.019865	96	0013.253524	97	0013.318604	81	0013.399028	111
0010.397500	16	0011.046000	46	0011.381949	62	0013.019900	81	0013.253526	97	0013.318616	81	0013.399029	116
0010.399023	20	0011.046000A	46	0011.382429	67	0013.019900A	81	0013.253529	97	0013.318617	81	0013.399031	110
0010.399025	20	0011.256811	44	0011.382436	67	0013.019902	92	0013.253536	97	0013.318657	81	0013.399032	118
0010.399028	20	0011.256811	54	0011.382449	67	0013.019902A	92	0013.253811	98	0013.318660	81	0013.399033	118
0010.399029	26	0011.256824	54	0011.382529	67	0013.019902B	92	0013.253824	98	0013.318904	87	0013.400001	117
0010.399032	26	0011.256826	54	0011.382536	67	0013.020100	81	0013.253826	98	0013.318916	87	0013.400003	117
0010.400001	25	0011.256829	54	0011.382549	67	0013.020100A	81	0013.253829	98	0013.318960	87	0013.400004	117
0010.400003	25	0011.256836	54	0011.384629	62	0013.020600	80	0013.253836	98	0013.322004	82	0013.400005	109
0010.400004	25	0011.256862	54	0011.384636	62	0013.020600A	80	0013.253865	98	0013.322004	85	0013.401500	109

Art.nr.	Pag.	Art.nr.	Pag.	Art.nr.	Pag.	Art.nr.	Pag.	Art.nr.	Pag.	Art.nr.	Pag.	Art.nr.	Pag.
0013.401503	117	0013.562004	137	0016.375130	18	0021.318516	171	0024.253036	202	0024.561500	218	0050.402102	244
0013.402010	122	0013.562004	142	0016.661660A	73	0021.318517	171	0024.253049	202	0024.561510A	218	0050.402103	244
0013.402011	122	0013.562007	136	0016.661660B	73	0021.318560	169	0024.253065	202	0024.561510B	218	0050.402104	244
0013.402012	122	0013.562007	142	0021.020100	168	0021.318560	171	0024.253067	202	0024.561530A	218	0050.402105	244
0013.402013	122	0013.562020	136	0021.020100A	168	0021.318604	168	0024.254911	202	0024.561530B	218	0050.402106	244
0013.402014	122	0013.562025	136	0021.020500	168	0021.318616	168	0024.254924	202	0024.561580	218	0050.402107	244
0013.402015	122	0013.562030	137	0021.020500A	168	0021.318617	168	0024.254926	202	0024.561589	219	0050.402108	244
0013.402016	122	0013.562035	138	0021.020600	168	0021.318660	168	0024.254929	202	0024.561591	227	0050.402109	244
0013.402017	122	0013.562036	139	0021.020600A	168	0021.370560	168	0024.254936	202	0024.562000	222	0050.402501	244
0013.402018	122	0013.562050A	140	0021.021500	168	0021.370660	168	0024.254963	202	0024.562001	222	0050.402502	244
0013.402019	122	0013.562050B	140	0021.021500A	168	0021.370960	168	0024.254963	202	0024.562002	222	0099.370000	86
0013.402020	122	0013.562060A	140	0021.021700	169	0021.375060	179	0024.254965	202	0024.562002	224	0099.975000	22
0013.402021	122	0013.562060B	140	0021.021700A	169	0021.375130	179	0024.254967	202	0024.562004	222	0099.975001	22
0013.402022	122	0013.562070A	141	0021.023400	169	0021.381929	182	0024.315604	199	0024.562004	224	0099.975002	22
0013.402023	122	0013.562070B	141	0021.023400A	169	0021.381936	182	0024.315616	199	0024.562007	223	0099.975343	21
0013.402024	122	0013.605000	126	0021.025400	169	0021.381949	182	0024.315617	197	0024.562007	224	0099.975343	97
0013.402025	122	0013.605011	126	0021.025400A	169	0021.384629	182	0024.315620	198	0024.562030	222	0099.975343	209
0013.402026	122	0013.605013	126	0021.027700	169	0021.384636	182	0024.315660	199	0024.562050A	223	0099.975363	21
0013.402027	122	0013.605090	85	0021.027700A	169	0021.384649	182	0024.317304	198	0024.562050B	223	0099.975363	97
0013.402028	122	0013.605090	127	0021.027700B	169	0021.393033	178	0024.317316	198	0024.692502	230	0099.975363	209
0013.402029	122	0013.605120	127	0021.027800	170	0021.397500	178	0024.317317	198	0024.692503	230	0099.975364	21
0013.402501	122	0013.617050	127	0021.027800A	170	0021.399023	181	0024.318604	198	0024.692504	230	0099.975364	97
0013.402502	122	0013.661610	128	0021.027800B	170	0021.399025	181	0024.318616	198	0024.847773	226	0099.975364	209
0013.402503	122	0013.661611	128	0021.029200	170	0021.399027	181	0024.318660	198	0024.847822	226	0099.975380	202
0013.403500	111	0013.661650A	131	0021.029200A	170	0021.400001	184	0024.370560	198	0024.847930	226	0099.975440	202
0013.404002	123	0013.661651A	131	0021.029200B	170	0021.401500	180	0024.370660	198	0024.847970	226	0099.975460	202
0013.404004	123	0013.661651B	131	0021.031500	170	0021.403500	181	0024.375060	206	0024.848020	227	0099.990120	18
0013.405525	111	0013.661651B	131	0021.031500A	170	0021.426180	192	0024.375100	206	0024.875250	227	0099.990120	21
0013.405530	166	0013.661652A	132	0021.032300	171	0021.426190	192	0024.381929	210	0024.875611	227	0099.990120	206
0013.405531	166	0013.661652B	132	0021.032300A	171	0021.442000	190	0024.381936	210	0050.019902	232	0099.990121	18
0013.405532	166	0013.692500	158	0021.032400	171	0021.442020	190	0024.381949	210	0050.019902A	232	0099.990121	21
0013.426190	150	0013.692501	158	0021.032400A	171	0021.442040	190	0024.382029	209	0050.019902B	232	0099.990121	206
0013.426192	150	0013.692502	158	0021.042000	170	0021.454000	188	0024.382036	209	0050.029502	232	0099.990122	18
0013.426193	150	0013.692503	158	0021.042000A	170	0021.454001	188	0024.382049	209	0050.029502A	232	0099.990122	21
0013.442000	146	0013.692504	158	0021.172502	174	0021.605000	186	0024.382129	210	0050.029502B	232	0099.990122	206
0013.442020	146	0013.692511	158	0021.172502A	174	0021.605011	186	0024.382136	210	0050.045202	232	0099.990140	116
0013.442040	146	0013.692512	158	0021.172502B	174	0021.605013	186	0024.382149	210	0050.045202A	232	0099.997470	16
0013.447600	148	0013.692513	158	0021.173502	174	0021.617050	186	0024.384629	209	0050.045202B	232		
0013.450021	148	0013.692514	158	0021.173502A	174	0021.847740	194	0024.384636	209	0050.045302	233		
0013.454000	144	0013.692611	158	0021.173502B	174	0021.847741	194	0024.384649	209	0050.045302A	233		
0013.454001	144	0013.692612	159	0021.253011	175	0021.847742	194	0024.393030	204	0050.045302B	233		
0013.561500	129	0013.692613	159	0021.253024	175	0021.847881	194	0024.393033	204	0050.045402	233		
0013.561510A	129	0013.692620	159	0021.253026	175	0021.847920	194	0024.393045	205	0050.045402A	233		
0013.561510B	129	0013.724520	162	0021.253029	175	0021.847921	194	0024.397500	204	0050.045402B	233		
0013.561520A	129	0013.724521	162	0021.253036	175	0021.847930	194	0024.399023	208	0050.322416	232		
0013.561520B	129	0013.724530	163	0021.253049	175	0021.847950	195	0024.399025	208	0050.322417	232		
0013.561530A	129	0013.724531	163	0021.253065	175	0021.847970	195	0024.399033	212	0050.322460	232		
0013.561530B	129	0013.752510	153	0021.253067	175	0021.875601	195	0024.400001	213	0050.375060	237		
0013.561540	130	0013.752520	153	0021.254911	176	0021.875602	195	0024.400004	213	0050.375100	237		
0013.561541	130	0013.752530	153	0021.254924	176	0021.875610	195	0024.400005	207	0050.384629	241		
0013.561550A	130	0013.847600	154	0021.254926	176	0021.875630	196	0024.401500	207	0050.384636	241		
0013.561550B	130	0013.847661	154	0021.254928	176	0024.020100	198	0024.402010	216	0050.384649	241		
0013.561560A	130	0013.847662	154	0021.254929	176	0024.020100A	198	0024.402011	216	0050.384929	241		
0013.561560B	130	0013.847663	154	0021.254936	176	0024.020200	198	0024.402012	216	0050.384936	241		
0013.561580	133	0013.847664	154	0021.254962	176	0024.020200A	198	0024.402013	216	0050.384949	241		
0013.561581	133	0013.847771	154	0021.254963	176	0024.023400	198	0024.402014	216	0050.385029	240		
0013.561589	133	0013.847773	154	0021.254965	176	0024.023400A	198	0024.402015	216	0050.385036	240		
0013.561590	152	0013.847774	154	0021.254967	176	0024.025400	198	0024.402016	216	0050.385049	240		
0013.561591	152	0013.847810	154	0021.317304	169	0024.025400A	198	0024.402017	216	0050.385129	240		
0013.561600	152	0013.847811	154	0021.317316	169	0024.027800	199	0024.402018	216	0050.385136	240		
0013.561601	152	0013.847813	154	0021.317317	169	0024.027800A	199	0024.402019	216	0050.385149	240		
0013.561620	152	0013.847822	155	0021.317360	169	0024.027800B	199	0024.402501	216	0050.393033	236		
0013.561640	153	0013.847823	155	0021.317816	174	0024.253011	202	0024.402502	216	0050.399026	239		
0013.562000	136	0013.875280	153	0021.317817	174	0024.253024	202	0024.402503	216	0050.400011	238		
0013.562001	136	0013.875300	153	0021.317860	174	0024.253026	202	0024.403500	208	0050.402100	244		
0013.562002	136	0016.318660	14	0021.318504	171	0024.253029	202	0024.405525	208	0050.402101	244		

Ook van Intersteel



Signature: **Sliced**

Arjan Moors

Exclusief deurbeslag van Intersteel, ontworpen door product- en interieur ontwerper Arjan Moors. Geïnspireerd op de eenvoud van het alledaagse.

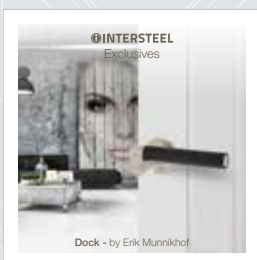

Dock line

By Erik Munnikhof

Industrieel ontwerper Erik Munnikhof ontwierp deze exclusieve lijn modulair opgebouwd deurbeslag voor Intersteel.

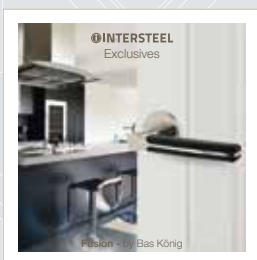

Fusion

By Bas König

Geïnspireerd door zijn passie voor fusion koken, ontwierp Intersteel designer Bas König de Fusion lijn deur- en raambeslag. Een unieke combinatie van verschillende materialen, de strakke look van roestvast staal en de prettige feel van zwart rubber.

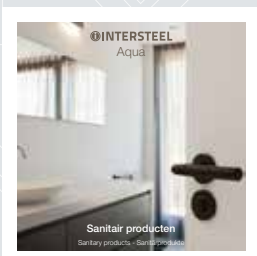

INTERSTEEL

Aqua

Een complete lijn badkamer- en toiletaccessoires van Intersteel. Deze producten zijn vervaardigd uit hoogwaardig roestvrij staal (AISI 316) met oog voor een functioneel en modern design!



INTERSTEEL

Veiligheidsbeslag

Een selectie uit het brede assortiment veiligheidsbeslag van Intersteel. Hoogwaardig roestvast staal met- en zonder kerntrekbeveiliging.



INTERSTEEL

Essentials 2 RVS

Het totale assortiment van ons RVS programma. Hoogwaardig roestvast staal in de kwaliteit die u van Intersteel gewend bent.

Disclaimer

Disclaimer

Voor de in dit productoverzicht opgenomen gegevens aanvaarden wij geen enkele aansprakelijkheid, evenmin als voor eventuele druk- en zetfouten en afwijkingen in de kleurproducties.

Wijzigingen in constructie en uitvoeringen van onze producten worden nadrukkelijk voorbehouden.

Gehele of gedeeltelijke overname van de in deze catalogus gepubliceerde gegevens uitsluitend na schriftelijke toestemming onzerzijds.

INTERSTEEL is een internationaal geregistreerd beeldmerk.

Disclaimer

We do not accept any responsibility for the facts noted in this product summary, nor for any misprints and defects in colour productions.

Alterations in construction and design of our products are emphatically reserved.

Information from this summary, whether complete or partial, can only be used by obtaining our written permission.

INTERSTEEL is an international registered trademark.

Anmerkung

Die in dieser Programmübersicht angegebenen Maße, Abbildungen und Zeichnungen sind unverbindlich. Modell- und Maßänderungen, sowie konstruktive Veränderungen behalten wir uns vor.

Erfahrungsgemas können Druckfarben nicht immer den Farbton originalgetreu wiedergeben. Farbabweichungen sind daher möglich.

Für Druckfehler und Irrtümer die bei der Erstellung dieser Programmübersicht unterlaufen sind, ist jede Haftung ausgeschlossen.

INTERSTEEL ist ein eingetragene internationale Warenzeichen.

Remarques

Nous nous réservons le droit de modifier nos produits, leurs finitions et leurs dimensions ; les dimensions, illustrations et caractéristiques sont mentionnées à titre indicatif. Les photos de ce catalogue ne sont pas contractuelles. Ce catalogue est notre propriété.

Nous en avons les droits pour tous les pays.

Toutes reproductions, même partielles, ne peuvent être faites qu'avec notre accord écrit.

INTERSTEEL est une marque déposée internationale.



Intersteel • Utrechtsestraatweg 220 • 3911 TX Rhenen • Postbus 128 • 3910 AC Rhenen
T +31 (0)318 - 47 77 77 • F +31 (0)318 - 47 77 78 • E info@intersteel.nl • W www.intersteel.nl

